

VALVE COMMUNICATION AND CONTROL

EXPLOSIONPROOF, NONINCENDIVE, I.S. & GENERAL PURPOSE
ON/OFF VALVE CONTROLLER

QUARTZ
QX/QN/QG





Quartz

Explosionproof valve monitoring

The Quartz is available in explosionproof (QX), nonincendive, intrinsically safe (QN), and general purpose (QG) versions. The robust epoxy-coated anodized aluminum construction, and optional stainless steel version, makes this platform extremely durable and well-suited for use in corrosive, heavy washdown environments.

Options may be selected to accommodate most applications.

Save space with low profile design

Clearance above the actuator is critical in complex piping systems. Quartz boldly displays valve position and encloses all electrical components in an explosionproof compartment with less than 5" clearance requirement.

The Quartz series

The Stonel Quartz series is durable, corrosion-resistant, and versatile, making it ideal for most of your process valve monitoring requirements.

Enclosures optimized for environment



QX: Explosionproof, water tight and corrosion-resistant enclosure is approved for use in Div. 1/Zone 1 hazardous areas. Available options include stainless steel and epoxy-coated anodized aluminum.



QN: Nonincendive is approved for Div. 2/Zone 2 hazardous environments with proximity sensors using a clear cover. Intrinsically safe NAMUR sensors or passive switches are available for Div. 1/Zone 0 applications.



QG: General purpose features a clear Lexan® cover with mechanical switches. All enclosures are rated NEMA 4, 4x, and 6.

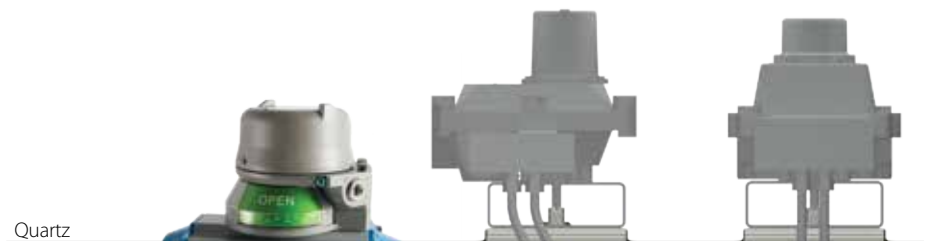

Quartz

Features

1. Enclosures optimized for environment

Available in three enclosure styles suitable for use in various process environment areas.

2. Rapid enclosure access

Screw-on cover allows quick enclosure access, saving you valuable maintenance and set-up time. The cover provides a vaportight seal and allows entry to internal components in less than five seconds.

3. Faster wiring

Pre-wired and labeled terminal strip enables quick, convenient attachment of field wires.

4. Wide variety of switching & communication

Switching options include dual module sensors and communication, Maxx-Guard proximity switches, and mechanical switches. Continuous signal output is available in a 4-20 mA position transmitter.

5. Quick set cams are easy to adjust

Touch and tune switch settings allow you to make adjustments in seconds without the use of tools.

6. Dual shaft o-ring seals eliminate corrosion

Top inner and bottom outer shaft o-rings seal the drive bushing from both external corrosives and internal contaminants that enter the enclosure.

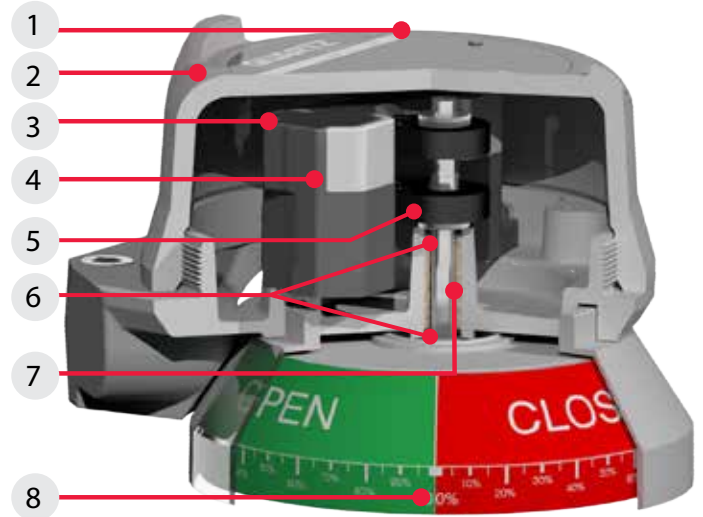

7. Special drive bushing assures long cycle life

The oil impregnated bronze bushing maintains smooth operation and eliminates the potential for shaft seizure due to actuator shaft eccentricity.

8. Bold space saving visual indication

Visual indicator offers excellent viewability without sacrificing accessibility or adding to space requirements. Indicators are also available with continuous percentage or three-way indication. (See page 57)

Wide variety of switch/sensor functions

A wide variety of switch/sensor communications and position transmitters may be selected for the Quartz series. Options include 2, 4 or 6 mechanical or proximity switches, position transmitters with or without switches, and the StoneL dual module with two SST or two

NAMUR sensors or AS-Interface, DeviceNet™ or Foundation Fieldbus communication capabilities.



Proximity switches



Mechanical switches

Speed installation with LED indication

StoneL's coordinated visual indicator and LEDs give you an extra measure of safety and increased convenience during plant start-up and operation. Green visual indication and green LED means the valve is open and the computer circuit is properly operating. Red visual indication and red LED means the valve is closed and the computer is properly matched. All systems are functioning properly.



Eliminate seal fittings in Division 1 and 2 areas

FMus ratings certify the Quartz QX series with proximity switches for use without seal fittings in all hazardous areas. By passing special pressure piling tests, the all aluminum enclosure was certified for this elite distinction. Now, a time-consuming procedure can be safely eliminated in Division 1 and Division 2 areas.

Consolidate your components and minimize costs

The Quartz design offers up to three conduit entries with extra wire terminations. By terminating solenoid valves in the switch enclosure, significant savings are realized by eliminating a junction box, wiring, conduit materials, and labor.



Mounting kits Kits may be ordered in 316 stainless steel. Consult StoneL factory for details.

Sealed mounting kit

Mounting to standard actuators is achieved with a bold visual indicator and sealed mounting system. Sealed mounting is exclusive with extended visual indicator option N. Adaptor plate is epoxy-coated anodized aluminum. All fasteners and couplings are stainless steel.



- Direct mount to actuators with VDI/VDE 3845 interface.
- Tolerant to vibration and mechanical stress.
- Prevents contamination and icing in coupling area.
- Available for all VDI/VDE 3845 (NAMUR) mounting configurations and most quarter-turn actuators.



Quarter-turn actuators

Low profile convenient mounting systems are readily available in stainless steel for most standard actuators.



Manual valves

Proper fit and operation is assured with StoneL's custom designs for each manual valve. Hundreds of unique mounting systems have been designed and fabricated for manually operated valves.



Positioners

Quartz position transmitter and switches may be retrofitted directly to most positioners. 4-20 feedback may be provided on simple pneumatic positioners.



Linear operators

Precision ball joint connections attach the Quartz to valve travel stems. Stroke lengths ranging from 20 mm to 150 mm (¾" to 6") may be easily accommodated.



Quartz Stainless Steel option



For the most challenging environments

The explosionproof Quartz for process valve monitoring is available with a 316 stainless steel enclosure that is extremely durable and well-suited for use in corrosive, heavy washdown and high seas environments. A broad range of switching, position transmitters and communication options may be selected to accommodate most applications. You can attach the Quartz to quarter-turn actuators, manual operators, linear operators, and positioners using readily available stainless steel mounting systems.



Available in short, medium and tall cover versions.



Position transmitter

4-20 mA position transmitter

Position transmitters provide a precise 4-20 mA signal on a two-wire DC loop. Control valves and dampers are accurately monitored through their range of travel offering assurance of exact valve position at all times. Select a standard potentiometer or a vibration proof, high-performance potentiometer on your position transmitter.



Load curve

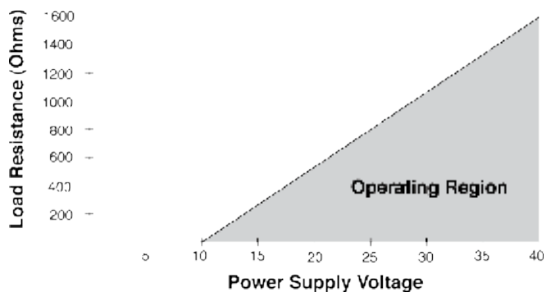

Position transmitter specifications

Position transmitter (5, 7)

Output	2-wire 4-20 mA
Supply source	10 - 40 VDC
Span range*	35° to 270° (adjustable)
Maximum loading	700 ohms @ 24 VDC
Linearity error	
Standard (5)	+/-0.85° maximum
High performance (7)	+/-0.35°
Cycle life	
Standard (5)	2 million rotations
High performance (7)	50 million rotations
Vibration tolerance	
Standard (5)	Acceptable
High performance (7)	Outstanding

*Please consult factory for higher spans.

Electrical schematic

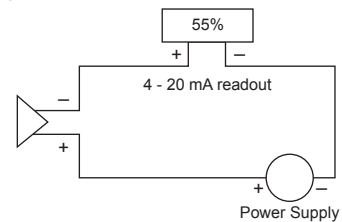

Sensors and communications

Dual module system

The Quartz series is available with the dual module in its various configurations. Two solid state sensors and/or communications and other electronics are sealed in for the ultimate in reliability and convenience. All dual module versions have a five year warranty.



Switching and sensor specifications

SST switching sensors (35)

Configuration	(2) SST solid state sensors Wire terminations for one or two solenoids
Operations	Normally open (NO) <i>for Normally closed (NC), consult factory</i>
Maximum current inrush	1.0 amp
Maximum current continuous	0.1 amp
Minimum on current	0.5 mA
Maximum leakage current	0.25 mA (AC) 0.15 mA (DC)
Voltage range	20 - 250 VAC 8 - 250 VDC
Maximum voltage drop	6.5 volts @ 10 mA 7.2 volts @ 100 mA

Wiring diagram (35)

Sensor specifications

NAMUR sensor (45)

Configuration	(2) NAMUR sensors (EN 60947-5-6; I.S.) Wire terminations for one or two solenoids
Operation	Normally closed NAMUR sensors (solid state)
Voltage range	5 - 25 VDC
Current ratings	Target on <1 mA Target off >3 mA

Wiring diagram (45)

Valve Communication Terminal (VCT) specifications

DeviceNet™ (92)

Configuration	(2) Discrete inputs (open and closed) (2) Power outputs (solenoids) (1) 4-20 mA auxiliary analog input, 10-bit resolution; no additional power source required
Transmission rate	Software selectable 125K, 250K or 500K baud
Messaging	Polling, cyclic and change of state
Outputs	4 watts @ 24 VDC outputs combined
Outputs, voltage	24 VDC (with input voltage ranging from 10 - 24 VDC)
Other features	Predetermined output fail state

Wiring diagram (92)

Sensors and communications

Valve Communication Terminal (VCT) specifications

AS-Interface (96)

Configuration	(2) Discrete sensor inputs (2) Auxiliary discrete inputs (2) Power outputs (solenoids)
Maximum current	160 mA, both outputs combined
Auxiliary inputs	24 VDC @ 2 mA (self-powered)
Output	4 watts @ 24 VDC both outputs combined
Outputs, voltage	21 - 26 VDC
Configuration code	ID=F, IO=4; user defined (4DI/2DO)
AS-i version	3.0
Devices per network	31

Wiring diagram (96)

AS-Interface VCT with extended addressing (97)

Configuration	(2) Discrete sensor inputs (2) Auxiliary discrete inputs (1) Power output (solenoid)
Maximum current	100 mA
Auxiliary inputs	24 VDC @ 2 mA (self-powered)
Output	2 watts @ 24 VDC
Output, voltage	21 - 26 VDC
Configuration code	ID=A, IO=4; user defined (4DI/1DO)
AS-i version	3.0
Devices per network	62

Wiring diagram (97)

Valve Communication Terminal (VCT) specifications

Foundation Fieldbus VCT, bus powered (93)

Configuration	(2) Discrete Inputs (2) Power outputs (solenoids) Multiple DI/DO blocks or modified output block
Outputs	2 mA @ 6.5 VDC each current limited to 2 mA (bus powered)
Devices per network	Max of 16 devices recommended

Wiring diagram (93)

Sensors and switches

Maxx-Guard proximity switch

Maxx-Guard hermetically-sealed switches are suitable for computer input circuits and general purpose applications. SPDT tungsten contacts are designed for 125 VAC computer inputs and 240 VAC moderate power applications. SPDT rhodium contacts are suitable for both 24 VDC and 120 VAC computer inputs. SPST ruthenium contacts are ideal for either 24 VDC or 125 VAC low power computer inputs.



Maxx-Guard proximity switch Single-Pole Single-Throw (SPST)	
J switch	
Configuration	SPST NO; passive (intrinsically safe)
Electrical ratings	0.10 amp @ 10 - 30 VDC
Maximum voltage drop	0.1 volts @ 10 mA 0.5 volts @ 100 mA
Contact composition	Ruthenium
P switch	
Configuration	SPST NO
Electrical ratings	0.15 amp @ 125 VAC/30 VDC
Maximum voltage drop	0.1 volts @ 10 mA 0.5 volts @ 100 mA
Contact composition	Ruthenium

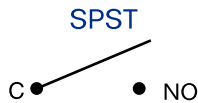

Specifications	
Temperature range	-40° C to 80° C (-40° F to 176° F)
Seal	Hermetically-sealed
Operating life	5 million cycles
Warranty	Two years

Maxx-Guard proximity switch Single-Pole Double-Throw (SPDT)	
G switch	
Configuration	SPDT
Electrical ratings	0.2 amp @ 120 VAC 0.30 amp @ 24 VDC
Maximum voltage drop	0.1 volts @ 10 mA 0.5 volts @ 100 mA
Contact composition	Rhodium
H switch	
Configuration	SPDT
Electrical ratings	240 volts max; 3 amps max 100 watts max; 2.0 watts min
Maximum voltage drop	0.1 volts @ 10 mA 0.5 volts @ 100 mA
Contact composition	Tungsten
M switch	
Configuration	SPDT; passive (intrinsically safe)
Electrical ratings	0.10 amp @ 10 - 30 VDC
Maximum voltage drop	0.1 volts @ 10 mA 0.5 volts @ 100 mA
Contact composition	Rhodium
S switch	
Configuration	SPDT (LED)
Electrical ratings	0.1 amp @ 120 VAC 0.1 amp @ 24 VDC
Maximum voltage drop	3.5 volts @ 10 mA 6.5 volts @ 100 mA
Contact composition	Rhodium



Sensors and switches

Mechanical switch (SPDT)

Low cost single-pole double-throw mechanical switches with silver contacts are recommended for high power 125 VAC applications. Gold contacts may be used in 24 VDC computer input applications when cycle life does not exceed 100,000 operations.

Mechanical switch (SPDT)	
Silver contacts (_V switch)	
Electrical ratings	10 amp @ 125/250 VAC 0.5 amp @ 125 VDC
Operating life	400,000 cycles
Not recommended for electrical circuits operating at less than 20 mA @ 24 VDC.	
Gold contacts (_W switch)	
Electrical ratings	1 amp @ 125 VAC 0.5 amp @ 30 VDC
Operating life	100,000 cycles

Mechanical switch (DPDT)

Double-pole double-throw mechanical switches enable two electrical circuits to be activated simultaneously. Each switch circuit is electrically isolated from the other. As with standard silver contacts, DPDT switches are designed to operate in high-power applications.

Mechanical switch (DPDT)	
14 switch	
Electrical ratings	4.5 amp @ 125/250 VAC, 24 - 125 VDC
Operating life	250,000 (VAC), 100,000 (VDC) cycles
Not recommended for electrical circuits operating at less than 20 mA @ 24 VDC.	

SST switching sensor

Solid state SST proximity sensors are ideal for use in AC and DC computer input circuits.

SST switching sensors	
_X switch	
Operation	NO/NC (cam selectable)
Maximum current	
Inrush	1.0 amps @ 125 VAC/VDC
Continuous	0.1 amps @ 125 VAC/VDC
Minimum on current	2.0 mA
Leakage current	Less than 0.50 mA
Voltage range	24 - 125 VAC 8 - 125 VDC
Maximum voltage drop	6.5 volts @ 10 mA 7.5 volts @ 100 mA
Operating life	Unlimited
Warranty	Five years

Model selector

SERIES

QX Explosionproof dual modules and VCTs

FUNCTIONS

Sensor/switching modules (proximity type)

33 SST NO switching sensor dual module *[old]*

35 SST 240V NO switching sensor dual module *[new]*

44 NAMUR dual module *[old]* (EN 60947-5-6; I.S.)

45 NAMUR dual module *[new]* (EN 60947-5-6; I.S.)

Valve Communication Terminals (VCTs)

92 DeviceNet™

93 Foundation Fieldbus (bus powered; I.S.)

96 AS-Interface

97 AS-Interface (with extended addressing)

ENCLOSURE

B Aluminum North American (NEC/CEC)

K Aluminum International (IEC)

G Aluminum Brazilian

J* Stainless steel North American (NEC/CEC)

N* Stainless steel International (IEC)

W* Stainless steel Brazilian

* Available with 03 or 06 conduit entry only

CONDUIT ENTRIES

02 (1) 3/4" NPT & (1) 1/2" NPT

03 (1) 3/4" NPT & (2) 1/2" NPT

05 (2) M20

06 (3) M20

OUTPUT

S Short visual indicator

N Extended visual indicator

H Metso "H" coupler

VISUAL INDICATOR *[see chart on page 57]*

DM Red closed/green open

NM Green closed/red open

SM T-1 three way flow path

TM T-2 three way flow path

UM T-3 three way flow path

VM T-4 three way flow path

WM T-5 three way flow path

0M No indication

XM Special

AM Continuous

Model number example

QX 35 B 02 N DM - OPTIONAL

MODEL NUMBER **PARTNERSHIP ID**

Mounting hardware required and sold separately. Some models may include 5-digit identification suffix.

Model selector

SERIES

QX Explosionproof proximity switches

FUNCTIONS

Sensors

2E (2) P+F special 3-wire NPN sensor

2F (2) PNP solid state 3-wire P+F sensor

2G (2) SPDT Maxx-Guard (low current)

2H (2) SPDT Maxx-Guard (3 amp)

2L (2) SPST Maxx-Guard (LED)

2P (2) SPST Maxx-Guard

2S (2) SPDT Maxx-Guard (LED)

4G (4) SPDT Maxx-Guard (low current)

4H (4) SPDT Maxx-Guard (3 amp)

4L (4) SPST Maxx-Guard (LED)

4P (4) SPST Maxx-Guard

4S (4) SPDT Maxx-Guard (LED)

ENCLOSURE

B Aluminum North American (NEC/CEC)

K Aluminum International (IEC)

G Aluminum Brazilian

J* Stainless steel North American (NEC/CEC)

N* Stainless steel International (IEC)

W* Stainless steel Brazilian

* Available with 03 or 06 conduit entry only

CONDUIT ENTRIES

02 (1) 3/4" NPT & (1) 1/2" NPT

03 (1) 3/4" NPT & (2) 1/2" NPT

05 (2) M20

06 (3) M20

OUTPUT

S Short visual indicator

N Extended visual indicator

H Metso "H" coupler

VISUAL INDICATOR *[see chart on page 57]*

DM Red closed/green open

NM Green closed/red open

SM T-1 three way flow path

TM T-2 three way flow path

UM T-3 three way flow path

VM T-4 three way flow path

WM T-5 three way flow path

0M No indication

XM Special

AM Continuous

Model number example

QX 2G K 02 N DM - OPTIONAL

MODEL NUMBER **PARTNERSHIP ID**

Mounting hardware required and sold separately. Some models may include 5-digit identification suffix.

Model selector

SERIES
 QX Explosionproof mechanical switches and transmitters

FUNCTIONS

Mechanical switches

2V (2) SPDT switches
 2W (2) SPDT switches, gold contact
 4V (4) SPDT switches
 4W (4) SPDT switches, gold contact
 14 (2) DPDT switches

Position transmitters

50 Standard with no switches
 5G Standard with (2) SPDT Maxx-Guard (low current)
 5V Standard with (2) SPDT mechanical switches
 5W Standard with (2) SPDT mechanical switches, gold contact
 53 Standard with SST NO switching sensor dual module
 54 Standard with NAMUR dual module (EN 60947-5-6; I.S.)
 70 High performance (HP) with no switches
 7G HP with (2) SPDT Maxx-Guard (low current)
 73 HP with SST NO switching sensor dual module
 74 HP with NAMUR dual module (EN 60947-5-6; I.S.)

ENCLOSURE

B Aluminum North American (NEC/CEC)
 K Aluminum International (IEC)
 G Aluminum Brazilian
 J* Stainless steel North American (NEC/CEC)
 N* Stainless steel International (IEC)
 W* Stainless steel Brazilian
 * Available with 03 or 06 conduit entry only

CONDUIT ENTRIES

02 (1) 3/4" NPT & (1) 1/2" NPT
 03 (1) 3/4" NPT & (2) 1/2" NPT
 05 (2) M20
 06 (3) M20

OUTPUT

S Short visual indicator
 N Extended visual indicator
 H Metso "H" coupler

VISUAL INDICATOR [see chart on page 57]

DM Red closed/green open
 NM Green closed/red open
 SM T-1 three way flow path
 TM T-2 three way flow path
 UM T-3 three way flow path
 VM T-4 three way flow path
 WM T-5 three way flow path
 OM No indication
 XM Special
 AM Continuous

Model number example
 QX 2V B 02 N DM - OPTIONAL

MODEL NUMBER **PARTNERSHIP ID**

Mounting hardware required and sold separately. Some models may include 5-digit identification suffix.

Model selector

SERIES
 QG General purpose mechanical switches (clear cover)

FUNCTION

Mechanical switches

2V (2) SPDT switches
 2W (2) SPDT switches, gold contact
 4V (4) SPDT switches
 4W (4) SPDT switches, gold contact
 14 (2) DPDT switches

ENCLOSURE

P General purpose, universal

CONDUIT ENTRIES

02 (1) 3/4" NPT & (1) 1/2" NPT
 03 (1) 3/4" NPT & (2) 1/2" NPT
 05 (2) M20
 06 (3) M20

OUTPUT

S Short visual indicator
 N Extended visual indicator
 H Metso "H" coupler

VISUAL INDICATOR [see chart on page 57]

DM Red closed/green open
 NM Green closed/red open
 SM T-1 three way flow path
 TM T-2 three way flow path
 UM T-3 three way flow path
 VM T-4 three way flow path
 WM T-5 three way flow path
 OM No indication
 XM Special
 AM Continuous

Model number example
 QG 2V P 02 N DM - OPTIONAL

MODEL NUMBER **PARTNERSHIP ID**

Mounting hardware required and sold separately. Some models may include 5-digit identification suffix.

Model selector

SERIES

QN Nonincendive dual modules and VCTs

FUNCTIONS

Sensor/switching [proximity type]

33 SST NO switching sensor dual module *[old]*

35 SST 240V Universal NO switching sensor dual module *[new]*

Valve Communication Terminals (VCTs)

92 DeviceNet™

93 Foundation Fieldbus (bus powered) *[intrinsically safe]*

96 AS-Interface

97 AS-Interface with extended addressing

ENCLOSURE

Clear cover

P North American (NEC/CEC)

A International (IEC)

Aluminum cover [not explosion proof]

B North American (NEC/CEC)

K International (IEC)

G Brazilian

CONDUIT ENTRIES

02 (1) 3/4" NPT & (1) 1/2" NPT

03 (1) 3/4" NPT & (2) 1/2" NPT

05 (2) M20

06 (3) M20

OUTPUT

S Short visual indicator

N Extended visual indicator

H Metso "H" coupler

VISUAL INDICATOR [see chart on page 57]

DM Red closed/green open

NM Green closed/red open

SM T-1 three way flow path

TM T-2 three way flow path

UM T-3 three way flow path

VM T-4 three way flow path

WM T-5 three way flow path

OM No indication

XM Special

AM Continuous

Model number example

QN 35 P 02 S DM - OPTIONAL

MODEL NUMBER **PARTNERSHIP ID**

Mounting hardware required and sold separately. Some models may include 5-digit identification suffix.

Model selector

SERIES

QN Nonincendive proximity switches

FUNCTION

Sensors

2F (2) PNP solid state 3-wire P+F sensor

2G (2) SPDT Maxx-Guard (low current)

2H (2) SPDT Maxx-Guard (3 amp)

2L (2) SPST Maxx-Guard (LED)

2P (2) SPST Maxx-Guard

2S (2) SPDT Maxx-Guard (LED)

4G (4) SPDT Maxx-Guard (low current)

4H (4) SPDT Maxx-Guard (3 amp)

4L (4) SPST Maxx-Guard (LED)

4P (4) SPST Maxx-Guard

4S (4) SPDT Maxx-Guard (LED)

4X (4) SST sensor (LED)

ENCLOSURE

Clear cover

P North American (NEC/CEC)

A International (IEC)

Aluminum cover [not explosion proof]

B North American (NEC/CEC)

K International (IEC)

G Brazilian

CONDUIT ENTRIES

02 (1) 3/4" NPT & (1) 1/2" NPT

03 (1) 3/4" NPT & (2) 1/2" NPT

05 (2) M20

06 (3) M20

OUTPUT

S Short visual indicator

N Extended visual indicator

H Metso "H" coupler

VISUAL INDICATOR [see chart on page 57]

DM Red closed/green open

NM Green closed/red open

SM T-1 three way flow path

TM T-2 three way flow path

UM T-3 three way flow path

VM T-4 three way flow path

WM T-5 three way flow path

OM No indication

XM Special

AM Continuous

Model number example

QN 2G P 02 N DM - OPTIONAL

MODEL NUMBER **PARTNERSHIP ID**

Mounting hardware required and sold separately. Some models may include 5-digit identification suffix.

Model selector

SERIES

QN Intrinsically safe (I.S.) proximity switches and transmitters

FUNCTIONS

Sensor/switching modules (proximity type)

- 44 NAMUR dual module *[old]* (EN 60947-5-6; I.S.)
- 45 NAMUR dual module *[new]* (EN 60947-5-6; I.S.)

Sensor

- 2A (2) P+F special safety amplifier
- 2J (2) SPST (passive)
- 2M (2) SPDT (passive)
- 2N (2) P+F NAMUR sensors
- 4J (4) SPST (passive)
- 4M (4) SPDT (passive)
- 4N (4) P+F NAMUR sensors

Position transmitters

- 50 Standard with no switches
- 54 Standard with NAMUR dual module (EN 60947-5-6; I.S.)
- 70 High performance (HP) with no switches
- 74 High performance (HP) with NAMUR dual module (EN 60947-5-6; I.S.)

ENCLOSURE

Clear cover

- P North American (NEC/CEC)
- A International (IEC)

Aluminum cover *[not explosion proof]*

- B North American (NEC/CEC)
- K International (IEC)
- G Brazilian

CONDUIT ENTRIES

- 02 (1) 3/4" NPT & (1) 1/2" NPT
- 03 (1) 3/4" NPT & (2) 1/2" NPT
- 05 (2) M20
- 06 (3) M20

OUTPUT

- S Short visual indicator
- N Extended visual indicator
- H Metso "H" coupler

VISUAL INDICATOR *[see chart on page 57]*

- DM Red closed/green open
- NM Green closed/red open
- SM T-1 three way flow path
- TM T-2 three way flow path
- UM T-3 three way flow path
- VM T-4 three way flow path
- WM T-5 three way flow path
- OM No indication
- XM Special
- AM Continuous

Model number example

QN 45 P 02 N DM - OPTIONAL

MODEL NUMBER
Mounting hardware required and sold separately.

PARTNERSHIP ID
Some models may include 5-digit identification suffix.

Model selector

SERIES

QN Nonincendive proximity switches (position transmitters and expeditors)

FUNCTIONS

Position transmitters

- 50 Standard with no switches
- 5G Standard with (2) SPDT Maxx-Guard (low current)
- 53 Standard with SST NO switching sensor dual module
- 70 High performance (HP) with no switches
- 7G High performance (HP) with (2) SPDT Maxx-Guard (low current)
- 73 High performance (HP) with SST NO switching sensor dual module

ENCLOSURE

Clear cover

- P North American (NEC/CEC)
- A International (IEC)

Aluminum cover *[not explosion proof]*

- B North American (NEC/CEC)
- K International (IEC)
- G Brazilian

CONDUIT ENTRIES

- 02 (1) 3/4" NPT & (1) 1/2" NPT
- 03 (1) 3/4" NPT & (2) 1/2" NPT
- 05 (2) M20
- 06 (3) M20

OUTPUT

- S Short visual indicator
- N Extended visual indicator
- H Metso "H" coupler

VISUAL INDICATOR *[see chart on page 57]*

- DM Red closed/green open
- NM Green closed/red open
- SM T-1 three way flow path
- TM T-2 three way flow path
- UM T-3 three way flow path
- VM T-4 three way flow path
- WM T-5 three way flow path
- OM No indication
- XM Special
- AM Continuous

Model number example

QN 50 P 02 N DM - OPTIONAL

MODEL NUMBER
Mounting hardware required and sold separately.

PARTNERSHIP ID
Some models may include 5-digit identification suffix.

Specifications	
Materials of construction	
Housing & aluminum cover	Epoxy-coated anodized marine grade aluminum
Clear cover & indicator	Lexan® polycarbonate
Elastomer seals	Buna-N; optional EPDM
Drive shaft	Stainless steel
Drive bushing	Bronze, oil impregnated
Fasteners	Stainless steel
Temperature ratings	
Mechanical components	-40° C to 80° C (-40° F to 176° F)
Dual modules	-40° C to 80° C (-40° F to 176° F)
Maxx-Guard & SST	-40° C to 80° C (-40° F to 176° F)
Warranty	
Mechanical components	Two years
SST & dual modules	Five years
Lexan® is a registered trademark of General Electric Corporation.	

Ratings	
Explosionproof <i>(Ex d, Zone 1 or Class I and II, Div. 1)</i>	QX models*
Nonincendive <i>(Class I and II, Div. 2)</i>	QN models*
Intrinsically safe <i>(Ex ia, Zone 0 or Class I and II, Div. 1)</i>	Functions 44, 45, 93, _A, _J, _M and _N*
Enclosure protection	
NEMA 4, 4X and 6	All models
Ingress Protection 67	All models
Approvals*	See StoneL.com/approvals
* Only models listed on StoneL's official website are approved per specific rating.	

Dimensions mm [Inches]

Output option "S" - Short visual indicator

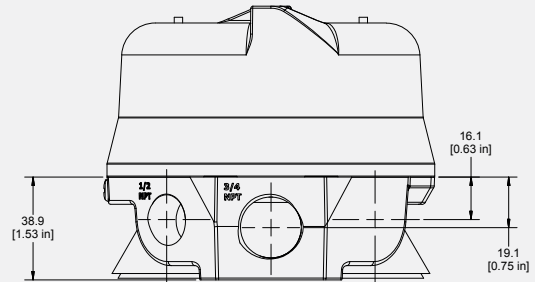
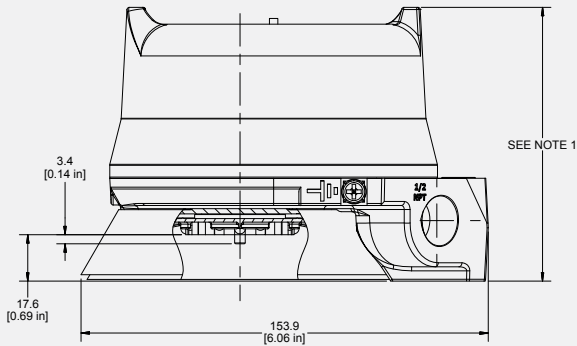

Output option "N" - Extended visual indicator

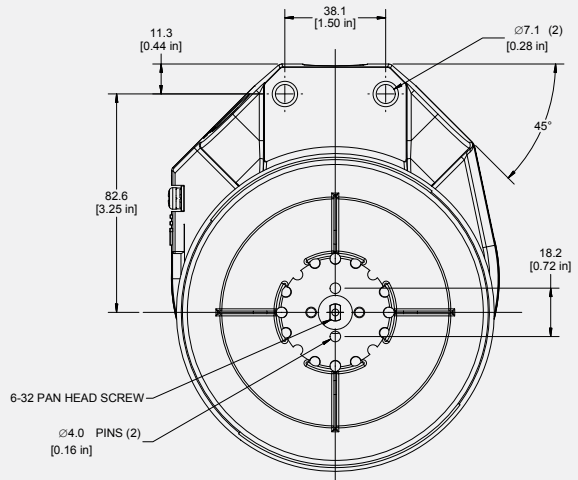
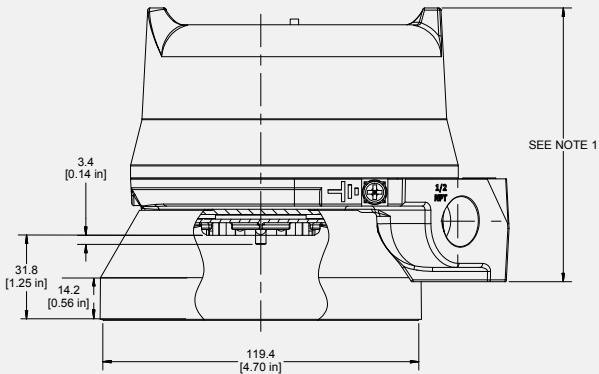



NOTE 1

Cover height varies based on model number.
 Dual module and 2-switch models use short covers.

- Short cover = 102 mm [4.0"]
- Medium cover = 123.4 mm [4.86"]
- Tall cover = 155.4 mm [6.12"]

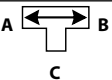
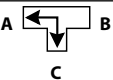
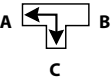
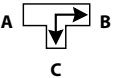
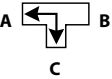
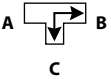
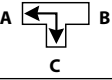
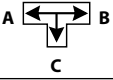
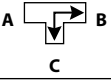
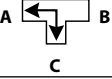
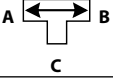
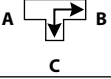
Visual indicator designations

DESIGNATION	0°	90°	180°
D	RED CLOSED	GREEN OPEN	
N	GREEN CLOSED	RED OPEN	
S			
T			
U		CLOSED	
V			
W			
A			
X	Specialty configuration - please consult factory		