

KOSMOS SERIE

CODE: 30727126 EDITION: 05-09-2006



INSTRUCTIONS MANUAL COUNTER – TOTALIZER TACHOMETER - TOTALIZER PART 1 / 2



MODEL BETA-D PROTOCOL MODBUS-RTU COMPATIBLE



INTRODUCTION TO THE KOSMOS SERIES

This catalogue does not constitute a formal agreement. All information given in this manual is subject to change without notice.

The KOSMOS SERIES brings a new philosophy in digital panel instrumentation which is expressed by multipurpose, modular-concept devices providing a rich array of basic functions and advanced capabilities.

With a fully MODULAR DESIGN, it is possible to implement a wide variety of applications by only adding the adequate options.

Intelligence within allows the meter to recognize the options installed and ask for the necessary parameters to properly function within desired margins. The basic instrument without output options omits these data in the program routines.

The instrument's CALIBRATION is made at the factory eliminating the need for adjustment potentiometers.

Any circuit or option that may need any adjust incorporates a memory where calibration parameters are stored, making it possible the optional cards be totally interchangeable without need of any subsequent adjust.

Custom CONFIGURATION for specific applications can be made quickly and easily through five front panel keys, following structured choice menus aided by display prompts at each programming step.

Other features of the KOSMOS family include :

- CONNECTIONS via plug-in terminal blocks without screws and CLEMP-WAGO clips cable retention system.
- DIMENSIONS
Models ALPHA & BETA 96x48x120 mm DIN 43700
Models MICRA & JR/JR20 96x48x60 mm DIN 43700
- CASE MATERIAL UL-94 V0-rated polycarbonate.
- PANEL INSTALLATION by means of single part fingertip without screws.

To guarantee the meter's technical specifications, it is advised to check its calibration at periodical intervals according to the ISO9001 standards for the particular application operating criteria. Calibration should be performed at the factory or in a qualified laboratory.

INDEX		
1.	General information 1.1. Introduction 1.2. Panel functions description	4-5 6-7
2.	Setting up 2.1. Package contents 2.2. Supply. Connectors 2.3. Input configuration. Connections 2.4. Programming introduction 2.5. Programming guide and summary of functions	8 9-10 11-12 13-14 15-16
3.	Counter configuration Index	17
4.	Tachometer configuration Index	27
5.	Batch counter Index	35
6.	Keyboard and back connector functions. Lock-out Index	40
7.	Characteristics, dimensions and mounting Index	49
APPENDIX	Index	59

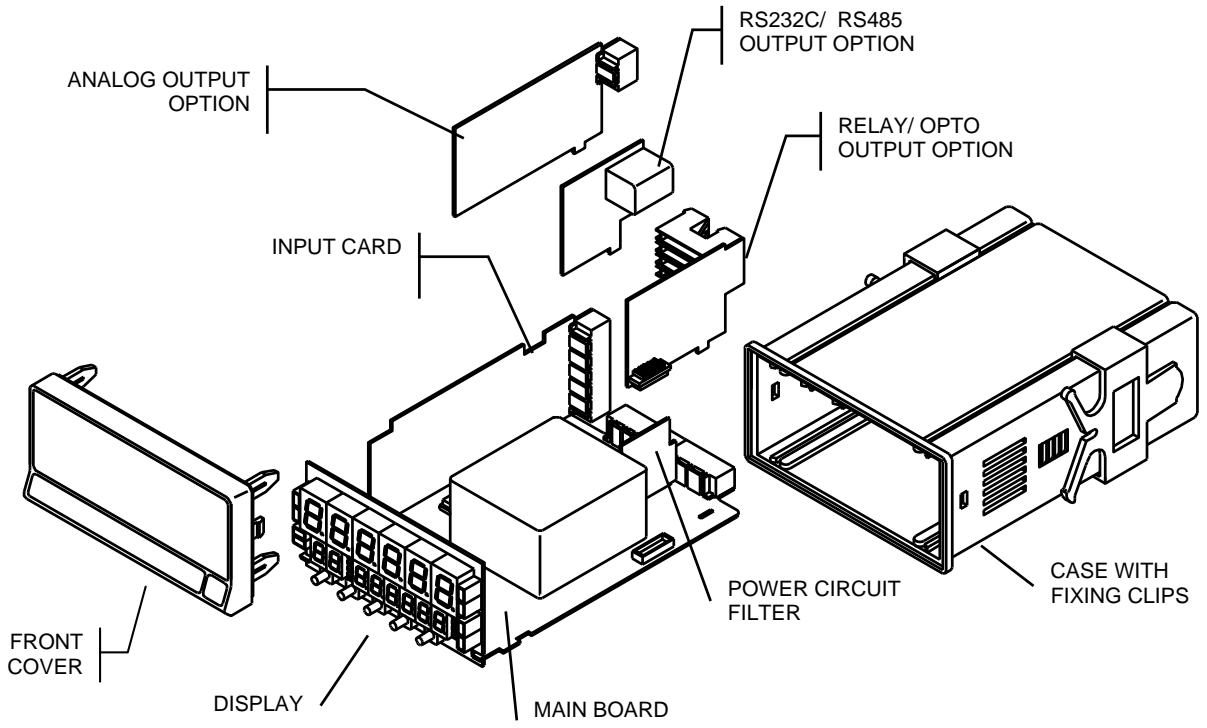

1. GENERAL INFORMATION

1.1. Introduction to BETA-D model

The Beta-D meter accepts digital inputs from a variety of sources including switch contact, outputs from TTL circuits, magnetic pickups ,NAMUR, PNP, NPN or encoder (TTL/24V).

The basic configuration is like one channel counter, where one input is used like main input counter and the other can be used like active input, direction or counting inhibit, other configuration is like a three channel counter, where two physical input count separately generating two independent counters and with the possibility to make arithmetical operations between them and generate a third counter. In both cases, every counter carry a totalizer shown thanks to the second display of the BETA-D.

Always is possible to change the main counter to a tachometer, by an easy menu selection. The tachometer has also a totalizer allowing to show at the same time the flow and Total volume accumulated.

If the totalizer associated to the tachometer is bi-directional, this has in addition indication of rotating direction

General characteristics :

Count signals in **quadrature x1, x2 y x4.**

Multiplier factor programmable from 0.0001 to 9999

Anti-debounce filter 100Hz, selectable

Counting selection by **fall and rise edge** or only by **rise edge.**

Batch counter with automatic cycle (increases of one unit of batch counter and automatic reset every time that the main variable overcomes the programmed level) **or manual** (increases one unit the batch counter every time that is done a reset of partial counter).

Offset programmable or stored from display

Function re-load (manual introduction of starting count of the variables)

Inhibition of keyboard functions offset, reset, load and visual

Refresh of display every 10ms

Store of process , batch and total values on Power-off

4 logical inputs with programmable functions of :

Printing setpoints and its situation

Selective printing of variables

Selective reset of variables, pulse, with hold or with stop of counter

Hold of display, of setpoints and outputs

Inhibition of inputs

1.2. Panel Functions description (Run mode)

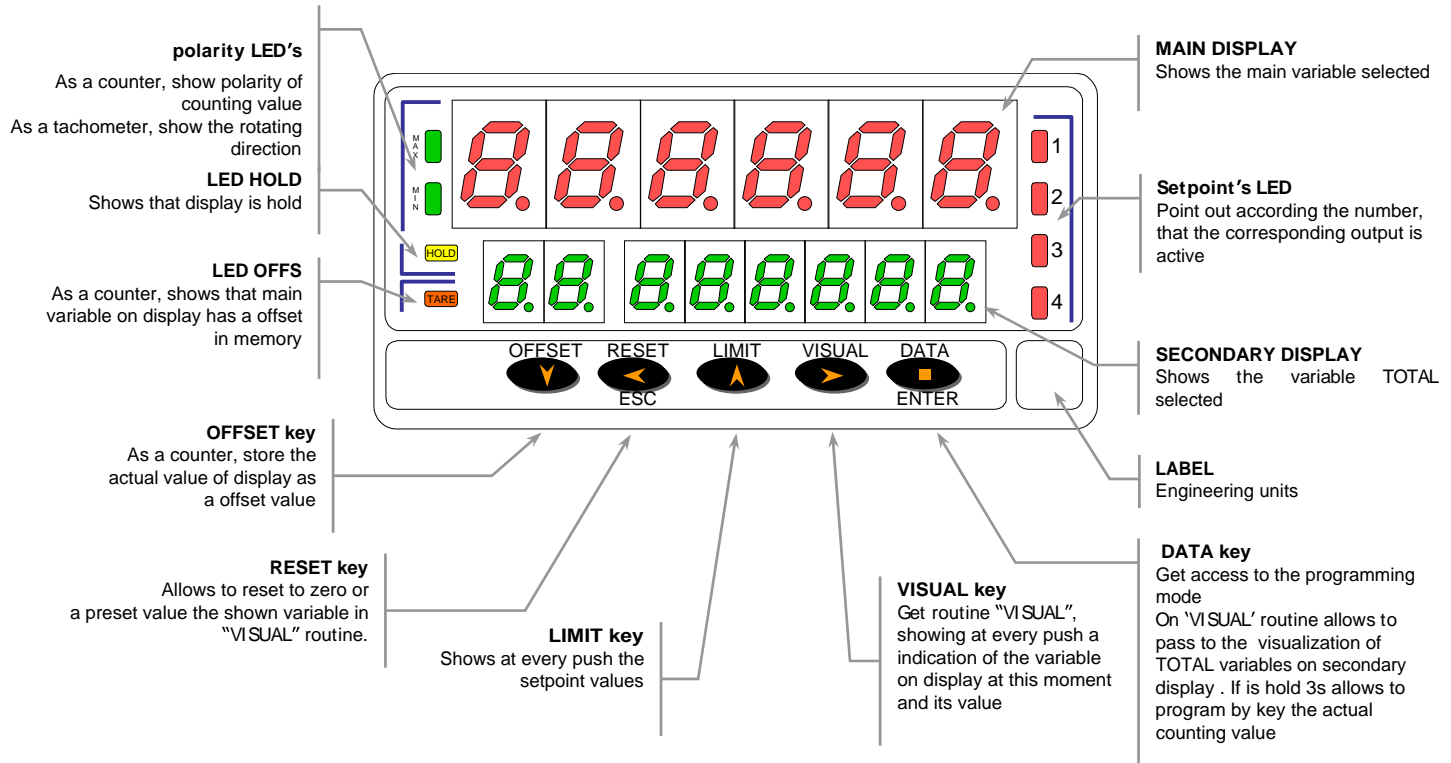

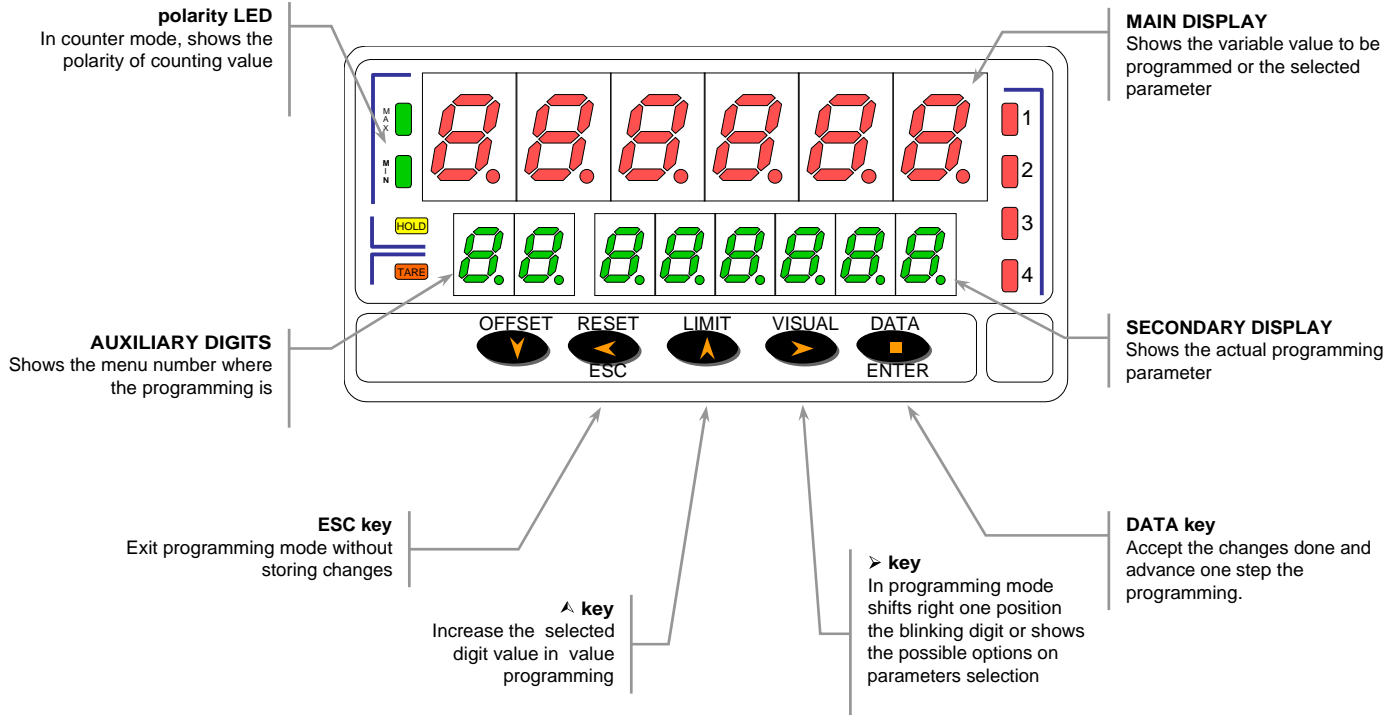

2.2. Power supply



Tabla 9.1: Jumpers situation.

Pin	1	2	3	4	5
230V AC	-	█	█	█	█
115V AC	█	█	█	█	-
48V AC	-	█	█	█	█
24V AC	█	█	█	█	-

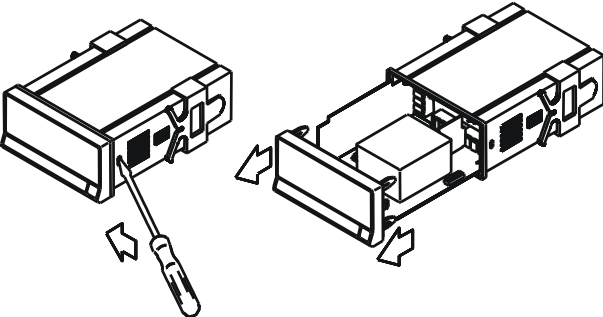
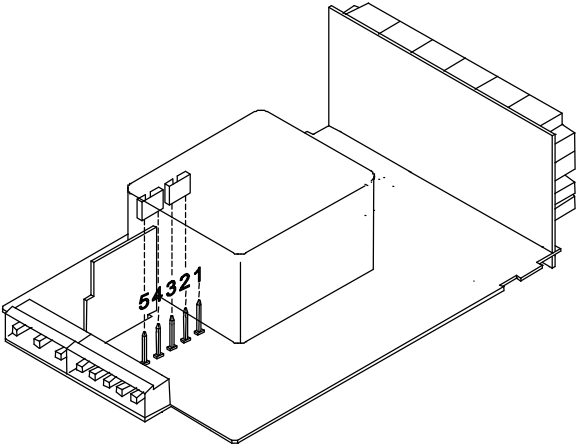
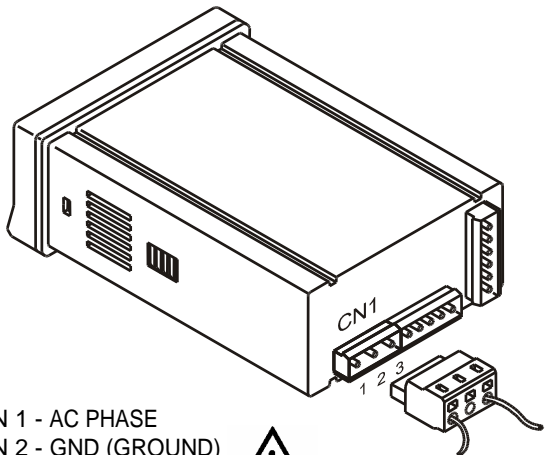

fig. 9.2 : Jumpers situation

POWER CONNECTION - CN1



PIN 1 - AC PHASE
PIN 2 - GND (GROUND)
PIN 3 - AC NEUTRAL



CONNECTORS

To perform wiring connections, remove the terminal block from the meter's connector, strip the wire leaving from 7 to 10 mm exposed and insert it into the proper terminal while pushing the fingertip down to open the clip inside the connector as indicated in the figure.

Proceed in the same manner with all pins and plug the terminal block into the corresponding meter's connector.

Each terminal accept cables of section between 0.08 mm² and 2.5 mm² (AWG 26 ÷ 14).

The blocks provide removable adaptors into each terminal to allow proper fastening for cable sections of <0.5 mm².

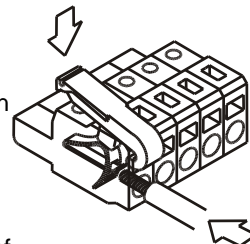

INSTALLATION

To meet the requirements of the directive EN61010-1, where the unit is permanently connected to the mains supply it is obligatory to install a circuit breaking device easy reachable to the operator and clearly marked as the disconnect device.

WARNING

In order to guarantee electromagnetic compatibility, the following guidelines for cable wiring must be followed:

- Power supply wires must be routed separated from signal wires. Never run power and signal wires in the same conduit.
- Use shielded cable for signal wiring and connect the shield to ground of the indicator (pin2 CN1).
- The cable section must be $\geq 0.25 \text{ mm}^2$

If not installed and used according to these instructions, protection against hazards may be impaired.

2.3. Input configuration and wiring

The input configuration should be done before to plug-in any sensor to the instrument.

On solder side of input circuit board there are two DIP-switch for input configuration A (SW1) and input B (SW2). The upper position is "ON".

Each input could be configured in a independent way.

The main sensor always have to be plugged-in on input A.

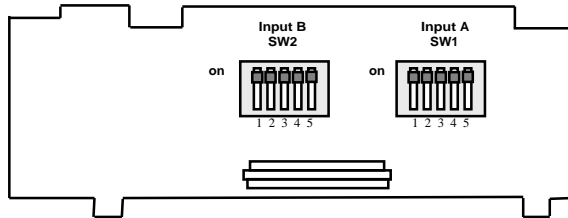
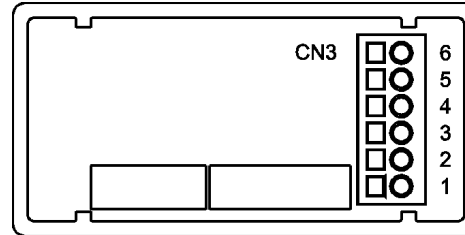

fig.11.1 : Solder side of input circuit board

Table 11.1. switch1 and switch2 Position

Sensorr	sw.1	sw.2	sw.3	sw.4	sw.5
Magnetic pickup	-	-	-	-	ON
NAMUR sensor	-	ON	-	ON	ON
TTL/24V (encoder)	-	ON	ON	-	-
NPN sensor	ON	ON	-	-	-
PNP sensor	-	ON	-	ON	-
Switch contact	ON	ON	ON	-	ON

WIRING CN3



PIN 6 **+EXC. 24V** (excitation output)

PIN 5 **+EXC. 8V** (excitation output)

PIN 4 **-IN** (common inputs A and B)

PIN 3 **+IN B** (positive input B)

PIN 2 **+IN A** (positive input A)

PIN 1 **N/C** (not connected)

When using two sensor the main sensor have to be connected to the input A and the secondary (which fixes counting direction) to the input B.

If only is used one sensor have to be connected to input A leaving out the input B connection .

(see inputs wiring on page 12)

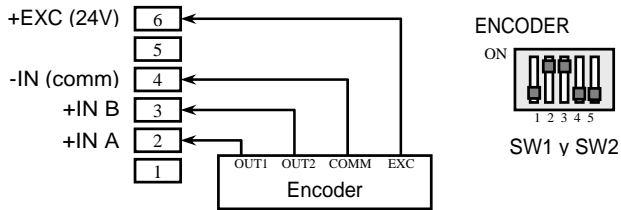
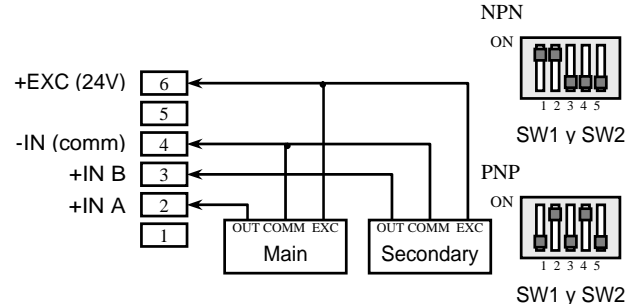
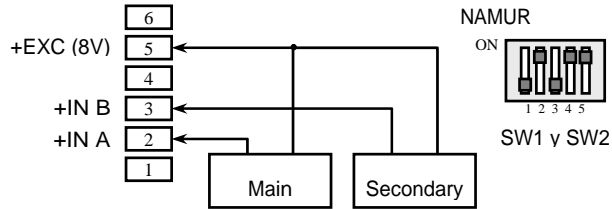
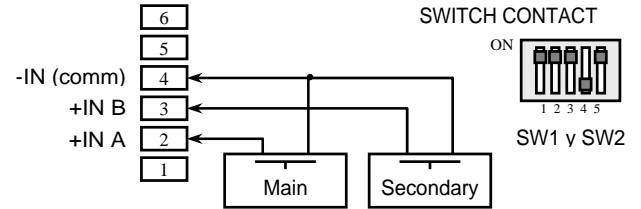
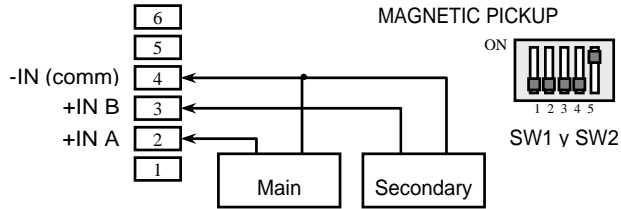

2.4. Programming instructions

Access to the programming mode

When power is applied to the instrument, the display briefly illuminates all segments and LED's then shows the software version and finally enters in the normal reading mode. Press **ENTER** to enter in the programming mode. The second display shows the indication "-Pro-" (fig. 13.1).

Exit from the programming mode without saving data

From any step of the program routines, a press on **ESC** returns the meter to the -Pro- stage. From this point, a new press of **ESC** shows momentarily the indication "qUlt" on the second display and the instrument enters in the run mode. Any change is discarded by exiting in this mode.

Save changes in the configuration

In the programming mode, the instrument returns to the -Pro- stage at the end of each program menu. The data changes are not saved at this point, to keep changes in the configuration parameters press **ENTER**, the second display shows momentarily the indication "StorE" while the new configuration is saved in the memory. After the instrument returns to the run mode.

Guidelines on programming instructions

The programming software is divided into 6 modules. Each module is organized in several independently accessible menus and each menu contains a list of parameters necessary to configure a specific function of the meter.

From the -Pro- stage, press repeatedly **▶** to cycle around the existing modules : module 10 = Input configuration, module 20 = display configuration, module 30 (if option installed) = setpoints, module 40 (if option installed) = analog output, module 50 (if option installed) = serial outputs and module 60 = logic functions. Press **ENTER** to access selected module.

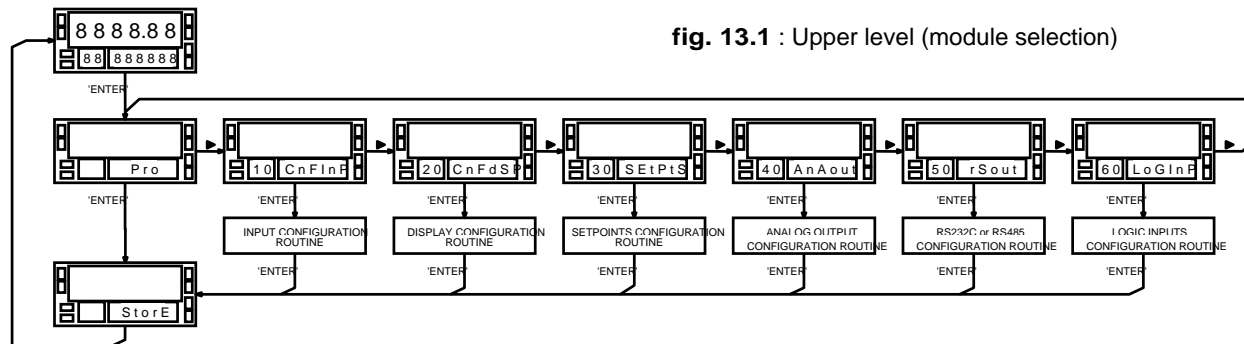



To access to the programming parameters

Thanks to the tree structure , the programming routines allow to access to change any parameter without need of looking over the whole menu.

Moving forward through programming

The advance through programming routines is done by pressings of  .

In general, the operations to do on every step will be press  a number of times to select a option and press  to validate the change and go to next programming step.

The numerical values are programmed digit to digit as explained on right paragraph.

Indications

The meter's configuration is constituted by numerical values and selectable options.

Generally the parameters value to be selected appears on main display, the menu's indication and parameter's type appear on secondary display. (The menu number is showed on two left digits).

The setpoint values or analog output values when referred to "TOTAL" will be programmed using the all digits of secondary display and the annunciator for this parameter will be showed on main display.

Programming numerical values

When the parameter has to be a numerical value, the display will put the first digit to be programmed flashing. On main display , if the variable can have polarity indication will flash one of the left LED's

The method to program the value is as follow :

Digit select : Press repeatedly the key  to shift from left to right through all digits (included LED's if necessary). (Digit active flashing).

Change the digit value : Press repeatedly the key  to increase the digit's value until to get the desired value. The first left digit on secondary display will show cyclically the values from 0 to 9, then the polarity minus (-) and so on.

On main display the polarity is programmed with the LED's on the left of display, the upper means positive and the lower negative.

Option select from a list

When the parameter has to be select from a list the key  allows us to round all possibilities from the list until appears on display the desired option.

2.5. Quick programming guide

Input and display programming instructions are divided into three sections :

SECTION 3. Counter configuration, where is described how to program number of channels, counting method , decimal point and multiplier factor apart from other options related with this configuration.

SECTION 4. Tachometer configuration, where is described how to scale the tachometer and related display options.

SECTION 5. Batch counter configuration, where is described the way of working and its programming method.

1./ The section 3 has to be read compulsorily in order to know the basic programming of the meter for any configuration (counter or tachometer), this is to say, selection of number of channels (see point 2.6.) and counter options / totalizer.

2./ Subsequently, if it's wanted to change the counter on main display by a indication of speed (flow, tach. etc...), will be necessary to activate the option tachometer (section 4).

2.6. Summary of working modes and their programming

Configuration 1 CHANNEL

The combination of input A and input B results in only one variable PROCESS ('ProC') and only one variable TOTAL ('tot')

Without option Tachometer

- **COUNTER UNIDIRECTIONAL WITH INHIBITION INPUT OR BIDIRECTIONAL WITH TOTALIZER (+ BATCH COUNTER OPTIONAL)**

The counting of number of pulses is done according to the input A and B combination. On main display is shown the partial counting value with polarity ('ProC') and on secondary display the "TOTAL" value with polarity ('tot').

If added the batch function , on main display will be shown the PROCESS ('ProC') or the batch counter (variable BATCH 'btCH') according to the selection done by key.

With option Tachometer

- **TACHOMETER WITH TOTALIZER AND ROTATING DIRECTION INDICATION**

The velocity measurement is done from of frequency of pulses on input A and is shown on main display ('ProC').

The measurement of total number of pulses is done according to the inputs A and B combination and is shown on secondary display. If the combination of A and B gives bidirectional counting, the polarity of main display shows the rotary direction.

3 CHANNEL configuration

INPUT A generates PROCESS variable ('ProC-A') and TOTAL ('tot-A').

INPUT B generates PROCESS variable ('ProC-b') and TOTAL ('tot-b').

One arithmetical function between 'ProC-A' and 'ProC-b' generates the 'ProC-C' variable and the same function between 'tot-A' and 'tot-b' generates the 'tot-C' variable.

Applications :

Without tachometer option

- 1 COUNTER UNIDIRECTIONAL WITH TOTALIZER (+ BATCH COUNTER OPTIONAL) PLUS
- 1 COUNTER UNIDIRECTIONAL WITH TOTALIZER (+ BATCH COUNTER OPTIONAL) PLUS
- 1 COUNTER WITH TOTALIZER (+ BATCH COUNTER OPTIONAL) AS A RESULT OF ARITHMETICAL FUNCTION BETWEEN THE TWO PREVIOUS.

From input A counts the number of pulses that will increase (or decrease) a partial counter ('ProC-A') and a total ('tot-A'). If it's added a batch option, a third variable will be generated 'btCH-A'.

In a separate way, the pulses on input B will increase (or decrease) the variables 'ProC-b' and 'tot-b'. If it's added the batch option, will be generated a third variable 'btCH-b'.

As a result of arithmetical function between the input A and B variables will have a third channel 'ProC-C', 'tot-C' and, in case exists a batch in both A y B channel, the variable 'btCH-C'.

With tachometer option

- 1 COUNTER UNIDIRECCIONAL WITH TOTALIZER (+ BATCH COUNTER OPTIONAL) AND
- 1 TACHOMETER WITH TOTALIZER AND
- 1 TOTALIZER AS A RESULT OF ARITHMETICAL OPERATION BETWEEN THE TWO PREVIOUS.

The measurement of the velocity is done from the frequency of the pulses on input A and generates the variable 'ProC-A' That will be show on main display. The total number of pulses applied at this input generates the variable 'tot-A' that will be show on auxiliary display.

Independently, from input B are counted the number of pulses to generate a partial counter 'ProC-b' and a total total 'tot-b'. If is added the option batch, will generate a third variable 'btCH-b'.

On the virtual channel only exists a variable "tot-C" that is the result of an arithmetical function between "tot-A" and "tot-B".

3. COUNTER WITH TOTALIZER

Index

SECTION	Pág.
3.1. Definitions	18
3.2. Input and display programming diagram	19
3.3. Input programming	
3.3.1. 1 channel - 3 channels selection	20
3.3.2. Counting methods	21-22
3.3.3. Arithmetical functions. Channel C	23
3.3.4. Additional options. Counting edge and filter	24
3.4. Display programming	
3.4.1. Scale. Decimal point and multiplier factor	25
3.4.2. Offset	26
3.5. Notes for 3 channel counter diagram	26

3.1. Glossary

PROCESS Variable

Is the main variable that in case of counter configuration corresponds to the input pulse measurement multiplied by a factor.

The PROCESS variable is shown on main display

TOTAL Variable

Is the total of pulses accumulated at the rate of the main variable without taking into account the actions that can produce over it a change of value (reset, load).

The TOTAL variable will always show the number of pulses detected multiplied by a factor.

The TOTAL variable will be shown on secondary display.

Channel

A channel is the set of measures done and related to the variables (PROCESS, TOTAL) to every one of the input or its combination

1 Channel Counter

It is a counter configuration where the two inputs are joined to form an only set of PROCESS and TOTAL variables.

In general the input A is used like a main input meanwhile the input B can be used like an active input or inhibit input or direction input.

This combination allows to get bidirectional counters (up and down).

3 Channels Counter

This configuration allows to count in a separate way the pulses on input A and the pulses on input B giving as a result three independent set of variables PROCESS and TOTAL; one for each input (Channel A and Channel B) and a third channel like a result of arithmetical operation between the two previous (Channel C).

In this configuration, every input is used to count in one direction (up or down) and it doesn't exist input for direction sense for that is not possible to have bidirectional counting.

Channel C (Only on 3 channels configuration)

The channel C is a result of an arithmetical operation between the display values of channel A and B.

The arithmetical function is done with the visible part of counters A and B, not being counted the decimal hidden part of them.

It is not refreshed the value at every pulse but at 10ms intervals.

On power-up, the variable C is charged with the corresponding value according to the relation of A and B.

The reset done on one variable of channel C makes a reset on variables A and B.

The setpoint options related to some variable of channel C will have a 10ms response time minimum.

3.2. Input and display configuration diagram

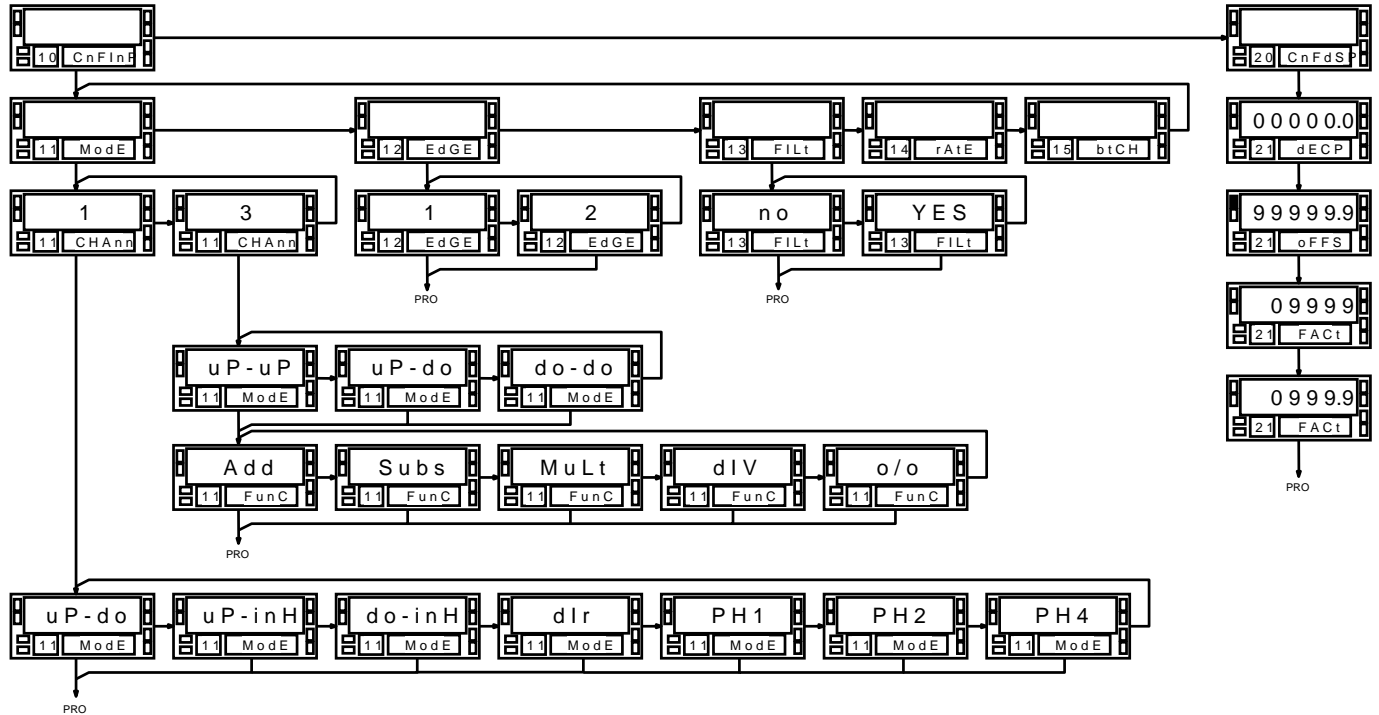

3.3. Input programming

3.3.1. 1 channel - 3 channels selection

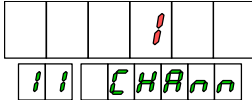

1 CHANNEL. The 1 channel configuration is the basic mode of counter where at least one of the input acts as a pulse input and the other like a counting direction, inhibition or like a pulse input to count in reverse direction of the main input.

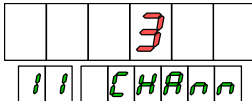

3 CHANNELS. In 3 channels configuration, the pulses at every input increase or decrease two independent counters (one for each input)

To have a bidirectional counter, this is to say, able to count and discount, it should be programmed with "1 CHANNEL" option.

To have 2 independent counts, should be programmed with "3 CHANNEL" option.

Example :

Measurement of the number of cars through the entrance and through the exit in a parking, to know how many cars remain inside.

With 1 channel configuration, using one of the meter's input to count the cars through the entrance and the other to discount what are going out (up-do Mode) at every instant we know how many cars remain inside the parking. If there is a offset programmed (see p. 26) as a number of free places and inverting the inputs, we'll have always the indication of remaining free places.

Selecting 3 channel configuration, we should know the number of cars that have entered into the parking during a period of time (since last reset) on counter A, the number of cars that have exited from the parking on counter B and, programming the arithmetical function subtraction (SubS) between A and B, the counter C will show in all moment the number of cars inside of parking.

3.2. Counting methods

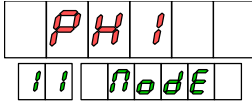

CONFIGURATION 1 CHANNEL

- uP-do** Adds input A and input B subtracts.
- up-inh** Adds input A if input B is low.
Input B is used like inhibition input.
- do-inh** Subtracts A if input B is low.
Input B is used like inhibition input.
- dir** Adds input A and subtracts if B is high. Input B is used like a direction input.
- PH1** Adds input A rising edge when input B is low
Subtracts input A falling edge when input B is low.
- PH2** Adds input A rising edge if B is low
Subtracts input A rising edge if input B is high.
Adds input A falling edge if B is high
Subtracts input A falling edge if input B is low.
- PH4** Adds input A rising edge if B is low
Subtracts input A rising edge if input A is high.
Adds input B rising edge if B is low
Subtracts input A rising edge if input B is high.
Adds input A falling edge if B is high
Subtracts input A falling edge if input B is low.
Adds input B falling edge if A is low
Subtracts input B falling edge if input A is high.

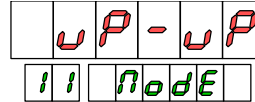

CONFIGURATION 3 CHANNELS

- up-up** Input A increases the counter A.
Input B increases the counter B.
- up-do** Input A increases the counter A.
Input B decreases the counter B.
- do-do** Input A decreases the counter A.
Input B decreases the counter B.

Like example the diagram shows a counter programmed up-up, considering that Channel C is the additions of channels A & B

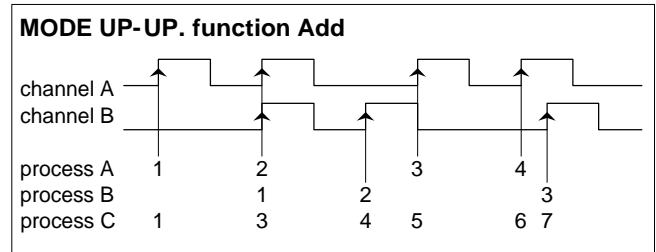

See arithmetical functions on p. 23

MODE UP-DO

A Adds. B Subtracts

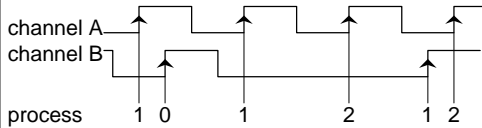

MODE UP-INH

A Adds if B is '0'. B inhibit counting.

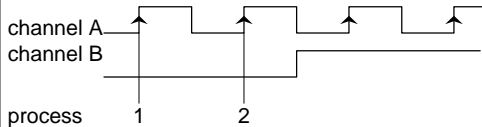

MODE DO-INH

A subtracts if B is '0'. B inhibit counting.

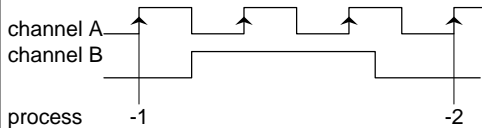

MODE DIR

A adds if B is '0' and subtracts if B is '1'.

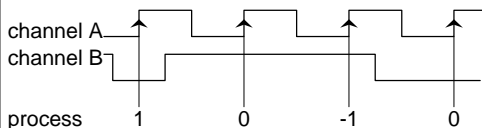

MODE PH1

Adds input A rising edge if B is '0'. Subtracts input A falling edge if B is '0'.

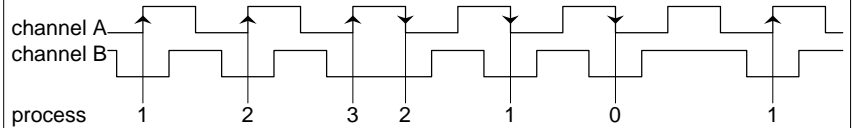

MODE PH2

Adds input A rising edge if B is '0' and subtracts if B is '1'. Subtracts input A falling edge if B is '0' and adds if B is '1'.

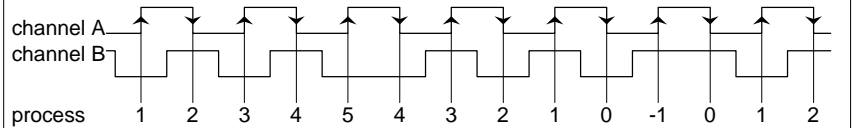

MODE PH4

Adds input A rising edge if B is '0' and subtracts if B is '1'. Subtracts input A falling edge if B is '0' and adds if B is '1'.

Adds input B rising edge if A is '1' and subtracts if A is '0'. Subtracts input B falling edge if A is '1' and adds if A is '0'.

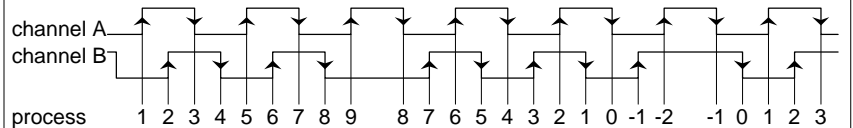

3.3.3. Arithmetical functions. Channel C

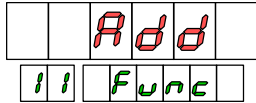

Add	Addition	$A + B$
SubS	Subtraction	$A - B$
MuLt	Multiplication	$A * B$
diV	Division	A / B
o/o	Percentage	$A / (A + B)$

When the counter is three channels,

The operation is done between the display values, never with the internal registers, for that, if exits some hidden decimal fraction on variables A and B, this will be not considered.

Example : Assumed that the display has no decimal point and the multiplier factor is 0,5. The channel A process value is 10,5 but the display shows 10, the channel B value is 2,5 and the display shows 2.

If the arithmetical function is addition, the channel C value will be 12 instead 13 because of the hidden decimal part.

CHANNEL C. Characteristics

The channel C is the result of an arithmetical operation between channels A and B.

The arithmetical function is done with the whole figure on display disregarding the hidden decimals.

When the selected arithmetical function is “%” ($A/(A+B)$), the C variable is shown with a decimal point and reaches a maximum value of 99.9 except for $B=0$, that is 100.0.

This channel is not updated at every pulse but a intervals of 10ms.

The setpoint output option related to any variable of channel C the response time will be aprox. 10ms.

After power-up, the C variables are loaded with the corresponding value according to the relation between A and B.

The reset function done over a C variable will make a reset of variables A and B.

The Load function has no effect on C counter.

3.3.4. Additional Options. Counting edge and anti-debounce filter

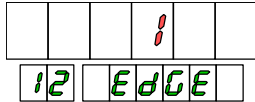

- 1 Counting on rising edge
- 2 Counting in both rising and falling edge

COUNTING EDGE. The counting option using rising and falling edges of input pulses allows to increase the accuracy of the measurement.
This option has no effect on modes PH1, PH2 y PH4.

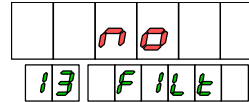

- no without filter
- YES anti-debounce filter 100Hz

ANTI-DEBOUNCE FILTER. When the input signal is coming from a switch contact or another element that can produce undesired signals like bounces is necessary to program filter yes to avoid counting errors.
With filter ('YES'), the maximum frequency is 100Hz.

3.4.1. Scaling. Decimal point and multiplier factor

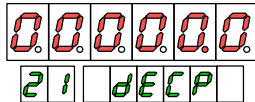

DECIMAL POINT. The decimal point position is active, and limits the display range.

Assumed a multiplier factor $\times 1$, and a display with two decimal positions, a counting value of 555 will be shown on display as 555.00. In this conditions the display should entry in overflow condition from 9999.00 misusing two display digits.

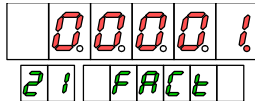

MULTIPLIER FACTOR. The multiplier factor is programmable between 0.0001 and 9999 with its own decimal point, for that is possible to get any value in the range independently of decimal position of display.

The display decimal point and multiplier factor are commons for all process and total variables.

On previous paragraph case, a factor of 0.01 should allow see all input pulses on display maintaining the indication with two decimals. The counting value 555 would be shown on the way 5.55.

If with the same factor, the decimal point of the display shift right one position (factor 0.01, display 0000.0), would be observed a change of a point of display every 10 entry pulses and the value of count 555 would be indicated of the form 5.5.

EXAMPLES :

COUNTING VALUE (pulses at the input) = 555

MULTIPLIER FACTOR $\times 1$

DISPLAY DECIMALS 2 (0000.00)

DISPLAY VALUE

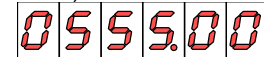

MULTIPLIER FACTOR $\times 0.01$

DISPLAY DECIMALS 2 (0000.00)

DISPLAY VALUE

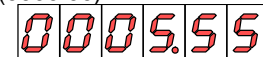

MULTIPLIER FACTOR $\times 0.01$

DISPLAY DECIMALS 1 (00000.0)

VALOR DE DISPLAY

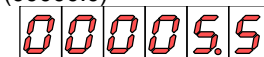

3.4.2. Offset

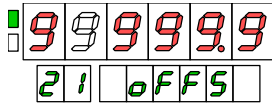

OFFSET. Offset is the value of beginning of a cycle of counting, that is to say, the value that takes the display when a reset is done. By default, the value of beginning of counter is zero in any of its configurations. Only the process variables (main display) can have offset, except Process-C if the counter is of 3 channels.

In a reset of the process, the totalizer is not increased with the value of offset. The totalizer accumulates the quantity of impulses of entry (multiplied by a factor) independently of what action it takes place in the display process. He does not remain affected by the quantities added to the main display that are not a consequence of an impulse in the input.

3.5. Diagram notes (3 channels counter)

The decimal point of the display is the same for all the variables PROCESS and TOTAL of both channels. There is a value of factor multiplier for the channel A and another different value for the channel B but with the decimal point in the same position. There is a value of offset for the channel A and another different value for the channel B.

On diagram of page 19, the module of display has been represented for the case of which the counter is of 1 channel.

If the counter was of 3 channels, two values would exist of offset programmable (oFFS -A and oFFS-b) and two factors multipliers (FAcT -A and FAcT-b). The decimal point of the factor is programmed for the channel A and the position is the same when is programmed the factor of the channel B.

4. TACHOMETER WITH TOTALIZER

Index

SECTION

4.1. Definitions	28
4.2. Input and display programming diagram	29
4.3. Input programming	
4.3.1. Tachometer selection and scaling	30
4.3.2. Examples	31
4.4. Display programming	
4.4.1. Special functions for measuring frequency	32
4.4.2. Display options for the totalizer	33
4.5. Diagram notes for 3 channel counter	34

4.1. Terminology

PROCESS variable

It is the main variable that, when the option tachometer is activated corresponds to the instantaneous speed measured from the frequency of the impulses of entry.

If the counter is of 3 channels there are two process variables; in the channel A, the instantaneous speed measured in the entry A and in the channel B, the number of impulses measured in the entry B.

TOTAL variable

It is the whole of impulses accumulated to the rate of the main variable without having into account the actions that can produce in this a change of value (reset, load).

The TOTAL variable always will indicate the number of detected impulses multiplied by a factor.

Sense of rotation

The indication of sense of rotation only is possible when the associated counter with the channel of speed measurement is bidirectional, that is to say, one can count in ascending (rising) and descending sense. This condition only is given in the configuration of 1 channel with the bidirectional manners of count (uP-do, dlr, PH1, PH2 and PH4).

1 Channel counter

In the configuration of tachometer, the instantaneous speed will constitute the variable PROCESS and the number of impulses for the TOTAL variable.

.

3 Channels counter

In the configuration of tachometer, the channel assigned to the measurement of frequency is the channel A which it will have the variables associate PROCESS A (instantaneous speed) and TOTAL A whereas the channel B will be a counter who will have the variables PROCESS B and TOTAL B.

The channel C will be constituted by the TOTAL variable C that will be a result of an arithmetical function between the variables TOTAL A and TOTAL B.

4.2. Diagram for modules Input and Display

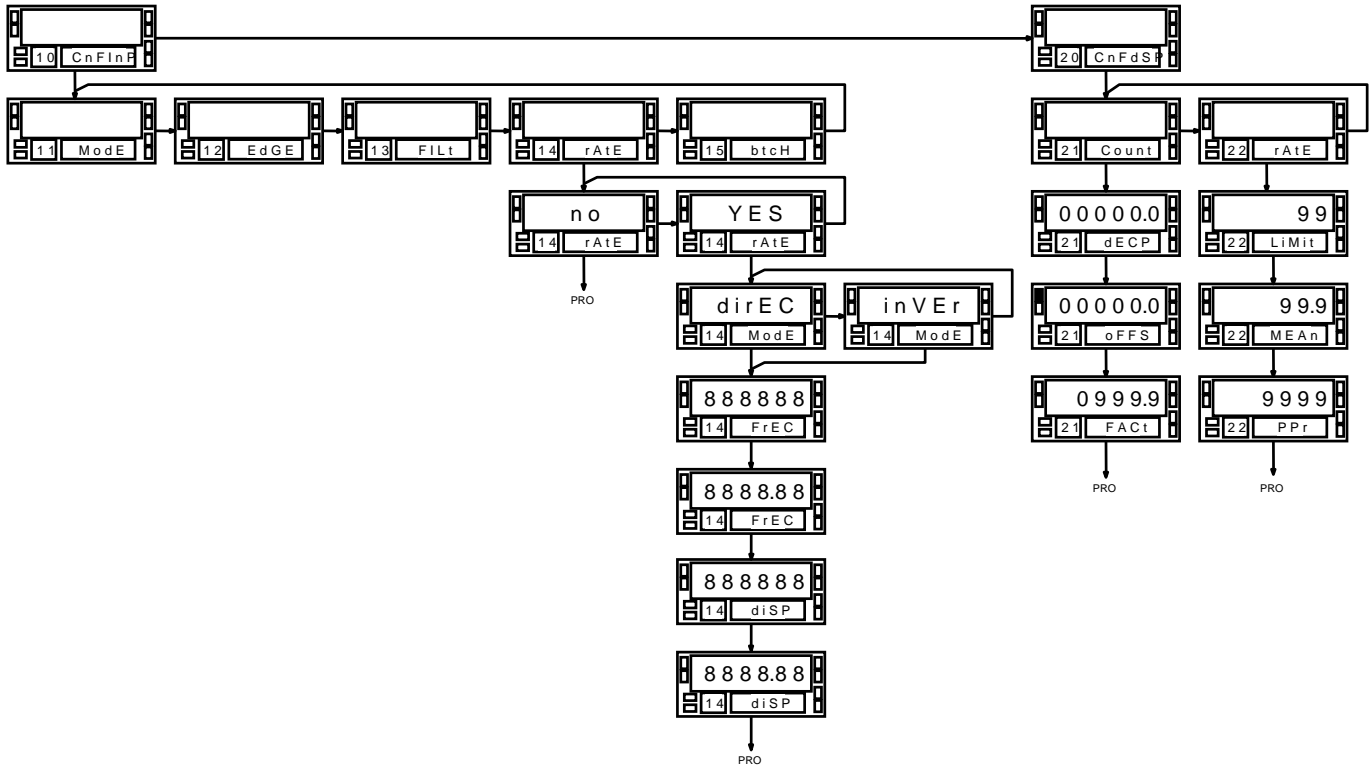

4.3. Input configuration

4.3.1. Tachometer selection and scaling



no Disable tachometer

YES Enable tachometer

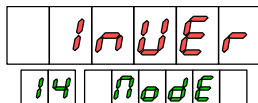
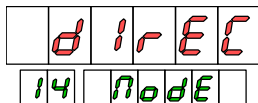

DIRECT SCALE. The relation frequency - display is directly proportional; to bigger frequency, bigger display and to less frequency less display. This it will be the desirable option in the majority of the applications.

INVERSE SCALE. The relation frequency - display is inversely proportional; to bigger frequency less display and vice versa. A typical application of this option is explained in the following page.

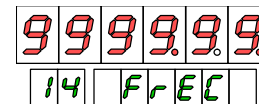
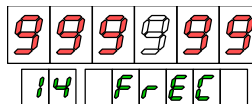

FREQUENCY OF ENTRY. To effects of scaling, the frequency of entry can be any value inside the range of display (the real limits of frequency are given in the table at the end of this document).

The decimal point can be placed in the digit 0, the 1 ó 2.

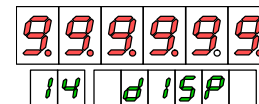
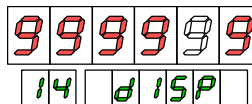

WISHED DISPLAY. The value to programming in this step is the value of display corresponding to the frequency programmed in the previous step. The decimal point can place in any of the digits of the display and is independent from the decimal point of the totalizer, which is programmed in the menu 21, module of display (see pag. 29).

4.3.2. Examples

The tachometer is able of indicating speed, flow or time by means of the introduction of only two parameters: Frequency of entry and Value of display

EXAMPLE

Loafs of bread are introduced in an continuous cooking oven by means of a conveyor belt. The average necessary time of stay of every piece in the oven is of 15min and 30s. The conveyor belt moves for a wheel of 20cms of diameter that provides 6 impulses for return. When the conveyor belt moves to the speed of 15min30s, the wheel turns to 300rpm.

The enunciated example allows to expose diverse utilities of the tachometer.

The speed of rotation of the wheel is of 300 revolutions in minute, which is equivalent to 5 revolutions per second.

If in a second the wheel carries out 5 turns and every turn provides 6 impulses, we have a whole of 30 impulses per second. The frequency of entry is at the time 30Hz.

SPEED OF THE CONVEYOR BELT (m/s)

To the specified frequency, the speed of the tape is
 $Rpm \cdot \pi \cdot diameter = 300 \cdot \pi \cdot 20 = 18849.6 \text{ cm/min}$ that is equivalent, in m/s, to 3.142m/s.

PARAMETERS TO PROGRAMMING:

MODE RATE: **DIRECT**

FREQUENCY OF ENTRY: **30**

VALUE OF WISHED DISPLAY: **03142**

DECIMAL POINT: **03.142** (m/s)

TIME OF COOKING (min)

It is needed to visualize the time that takes every loaf to pass for the interior of the oven knowing that to the calculated frequency (30Hz), the time of cooking is 15 min. 30 s. When it increase the speed (and the frequency), it will diminish the time of cooking, therefore we will have to programme the tachometer in inverse way.

PARAMETERS TO PROGRAMMING:

MODE RATE: **INVERSE**

FREQUENCY OF ENTRY: **30**

VALUE OF WISHED DISPLAY: **00155**

DECIMAL POINT: **0015.5** (min)

The programming of a value of display corresponding to a time has to be done in decimal notation. This way, for a time of cooking of 15min and 30s a value has been programmed of display of 15.5 (15 minutes and a half).

DAILY PRODUCTION (loafs/day)

There has been verified of trustworthy way that, in the conditions of the terms of reference, the loafs go out of the oven to an average of 10 per minute and the oven works 24 daily hours. The production of loafs is wanted to indicate for day.

Ten loafs per minute are $10 \times 60 = 600$ loafs per hour.

To the frequency of 30Hz, we have a daily production of $600 \times 24 = 14400$ loafs/day

PARAMETERS TO PROGRAMMING:

MODE RATE: **DIRECT**

FREQUENCY OF ENTRY: **30**

VALUE OF WISHED DISPLAY: **14400**

DECIMAL POINT: **NOT**

4.4. Display configuration

4.4.1. Special functions for frequency measurement

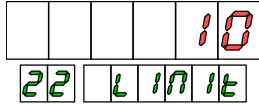

TIME LIMIT. The time limit, programmable between 1 and 99s it is applied to limit the time of wait in order that an impulse takes place in the entry before this one considers void.

Whenever an impulse is detected in the entry, an internal counter puts to zero. Every impulse restarts the counter so that, while impulses take place this one never comes to the value programmed as limit. When they stop the impulses and the counter completes the time limit, puts to zero the display and re-starts the measurement.

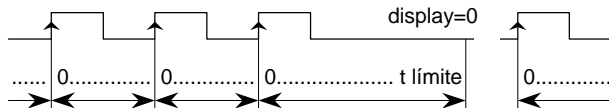

A reduction of this time will mean that the display puts to zero more rapidly when the system is stopped. Nevertheless, this reduction also limit the lowest frequencies (for example: with a time limit of 10s, it would be impossible to see low frequencies to 0.1Hz and with a time of 1s, low frequencies to 1Hz).

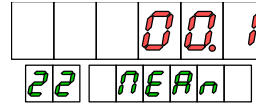

The instrument can present in display all the readings at a rate of 100 pro second (the display refreshes himself every 10ms) or an average of the readings realized during a programmable time: the **AVERAGE TIME**.

The average time is programmable from 0 to 99.9 seconds. If a value is programmed "0" average is not carried out. Of factory, this parameter comes programmed to 0.1s.

When troublesome variations should be observed in display due to the fact that the signal is unstable or irregular, an increase of the time can help to stabilize the display.

The average time can be calculated for a number of readings determined knowing the frequency of the signal. (Example: With the programming factory (0.1s), of a signal of lower frequency than 10Hz only will manage to take a reading, with which there is no average. Of a signal of 100Hz approximately 10 readings would take in 0.1s and of a signal of 1000Hz there would appear in display the average of approximately 100 readings).

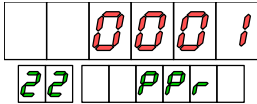

IMPULSES PER TURN. The reading of the frequency of entry is realized by the system of counting the time that is used to complete a period of the signal.
The period is taken between the positive edges of two consecutive impulses, which corresponds to a programming of PPr=0001.

If the input signal gives impulses at not regular intervals, the display will present fluctuations due to the fact that the periods of signal are not equal.

For example, we suppose a wheel that has a distribution of teeth that generates the following sign:

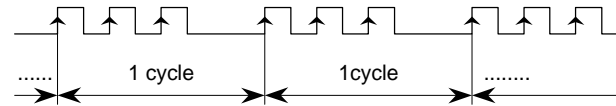

With a signal as that of the figure, if a measurement was taking for every impulse, the reading would be different in every measurement resulting in a fluctuating display.
To solve this case a value of 3 is programmed in the paragraph PPr.

4.4.2. Display options for totalizer

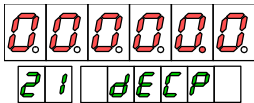

DECIMAL POINT. The decimal point can place in any of the digits of the main display.
Its position has value, that is to say, the entire part of a value will be visualized to the left of the decimal point and the decimal part to the right (to see explanations section 3.4.1. In pag. 25)

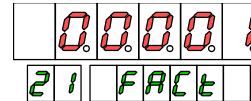

MULTIPLIER FACTOR. The multiplier factor is programmable between 0.0001 and 9999 with own decimal point, for which it is possible to obtain any value inside this range independently of the number of decimal positions of the display.

4.5. Notes to diagram (3 channels counter)

When the configuration is of 3 channels, the programming of the function 'rAtE' , is referred to only one channel, channel A, since the measurement of frequency will be effected only in the entry A.

The parameters of display relative to the frequency measurement (time limit, average time and impulses by cycle will be applied only to this input)

On the other hand, the parameters relative to the configuration of the counter (decimal point, offset and factor multiplier) double since, in configuration of 3 channels, the channel B is used as counter of impulses with totalizer and the channel A has a totalizer associated with the speed measurement, both are independently scaled except the decimal point that will be the same for the variables total-A, Process-b and total-b.

5. FUNCTION BATCH COUNTER

Index

SECTION

5.1. Definitions 36

5.2. Diagram function batch 37

5.3. Notes to diagram for a 3 channels counter 37

5.4. Selection and configuration function batch 38

5.5. Working diagrams 39

5.1. Terminology

Variable Batch

It is the number of times that is fulfilled a cycle of measurement, that is to say, the number of times that PROCESS variable puts to zero. This variable is generated when the function batch is enabled already in automatic form (BATCH is increased when the process reaches a prearranged value) as manual (BATCH is increased in every putting to zero of the process).

Sign

The variable BATCH always is entire and positive though there can be associated a counter of negative sign. For example can count quantity of boxes when removing the content.

Decimal point

The counter of lots does not have decimal point since the number of lots only can be an entire number.

Batch channel C

The variable BATCH-C is not generated from the variable PROCESS but an arithmetical operation between the variables batch of the channels A and B.

Mode automatic batch

The function batch auto, optional, is generated from a certain level of variable process allowing the count of lots of fixed quantities as, for example, boxes of 12 bottles, etc.

The counter of lots (variable BATCH) is increased in a unit whenever the partial counter (variable PROCESS) reaches the quantity for lot programmed. If the partial counter is affected of a factor multiplier so that the display does not pass for the exact programmed value, the lot will be completed by excess, that is to say, when the partial counter exceeds the programmed quantity, not adding the above mentioned excess to the following lot.

The partial counter, once reached the level batch, puts to zero or to the value of preset.

Mode batch by manual reset

The function batch reset is useful to take an individual control of every lot, for example, when the quantity of pieces or of material of every lot is different.

The function batch takes place whenever a reset of the process is carried out, already it is for keyboard, remotely or for action of a setpoint. When the operator thinks that the quantity of a lot is sufficient, remushroom the display I try, being increased automatically the variable BATCH in a unit and being initiated from then the count of the following cycle.

5.2. Menu batch diagram

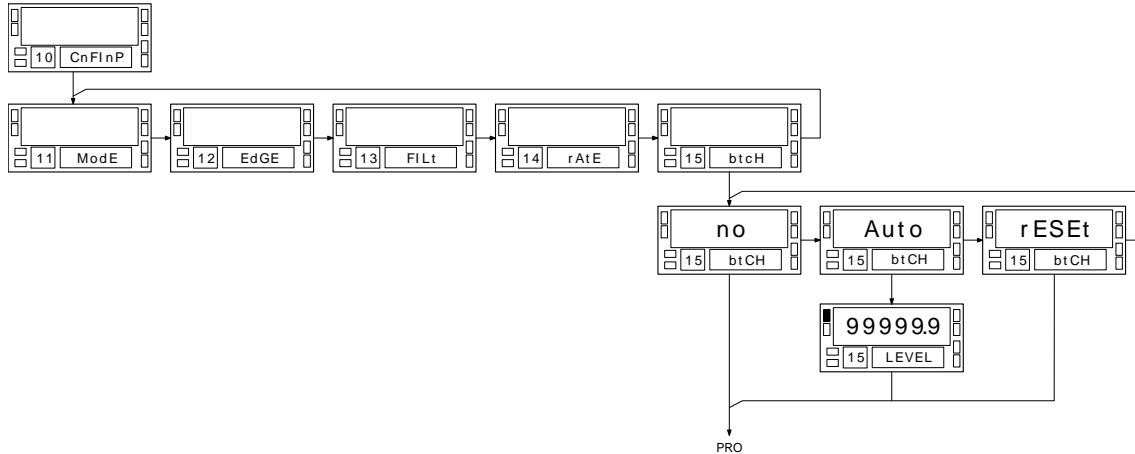

5.3. Notes to diagram (3 channels counter)

When the counter is of 3 channels, the programming of the function batch is realized two times (' btCH -A ' and 'btCH-b') one for every channel being completely independent as for type of function and level batch, that is to say, is possible to have the counter of lots activated in one only channel, or the automatic one and other one in way reset, etc..

When the option has been chosen batch in both channels A and B, automatically the counter of lots will be activated batch-C that will be the result of an arithmetical operation between the variables batch-A and batch-B.

This will not exist if only the function is activated in one of the channels.

5.4. Batch function selection and configuration

SELECTION FUNCTION BATCH

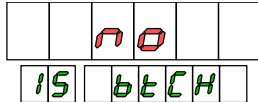

NO = disable function

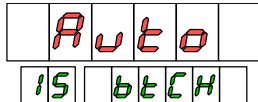

AUTOMATIC BATCH. The counter of lots (variable BATCH) is increased in a unit whenever the partial counter (variable PROCESS) reaches the quantity for lot programmed.

If the partial counter is affected of a factor multiplier so that the display does not pass for the exact programmed value, the lot will be completed by excess, that is to say, when the partial counter exceeds the programmed quantity, not adding the above mentioned excess to the following lot.

The partial counter, once reached the level batch, puts to zero or to the value of preset.

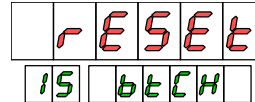

BATCH RESET. The function batch takes place whenever a reset of the process is carried out, already it is manual or for action of a setpoint. When the operator thinks that the quantity of a lot is sufficient, remushroom the display I try, being increased automatically the variable BATCH in a unit and being initiated from then the count of the following cycle.

LEVEL BATCH (Only MODE AUTO)

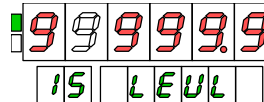

Level batch is the value of display in which the process variable is reset increasing in a unit the counter of lots. This value is programmed with sign and with the decimal point in the position of process variable.

5.4. Working diagrams

The level 'batch' is the value that is programmed as quantity of the lot.

The level 'offset' is the value in which a cycle of count begins the partial counter. A level offset different of zero can be useful, for example, in applications where boxes of pieces are wished be removed beginning the discount from a level of offset determined.

To illustrative effects, in the following graphs a level has been included of offset differently of zero that, since it can be observed, it does not affect the totalizer.

MODE UP. BATCH > OFFSET

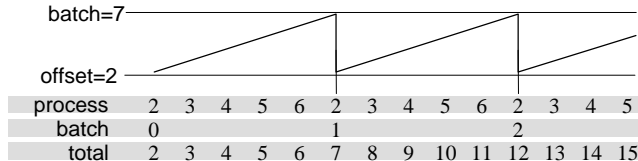

MODE DOWN. BATCH < OFFSET

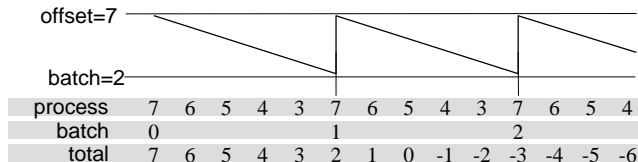

In bidirectional way, the function batch will be realized when an equal number of pieces is obtained to the programmed level, with independence of the previous evolutions of the counter.

Hereby it is possible to add and remove material with the safety of which only when there is reached the level of material wished by lot, will reset the partial counter and that of lots will be increased.

MODE UP/DOWN. BATCH > OFFSET

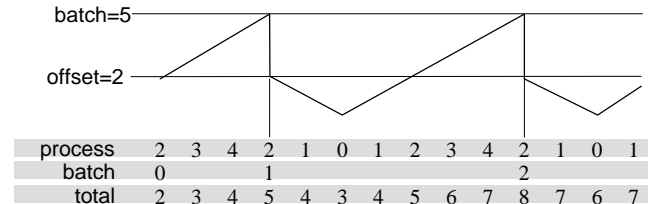

MODE UP/DOWN. BATCH < OFFSET

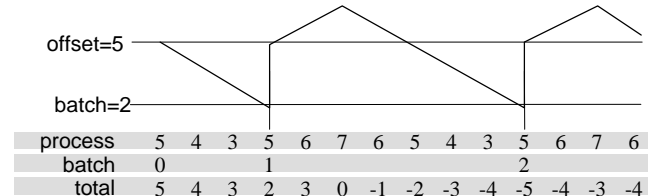

6. FUNCTIONS BY KEYBOARD AND REAR CONNECTOR. LOCKOUT

Index

SECTION	Pág.
6.1. Keyboard Functions	41-42
6.2. Logical functions on rear connector	
6.2.1. Wiring	43
6.2.2. Table of functions	44-45
6.2.3. Programming functions	46
6.3. Programming and keyboard functions lockout	47

6.1. Keyboard Functions

OFFSET KEY

Takes the value of the variable shown on upper display like OFFSET value for this variable.

OFFSET is the beginning counter value after to make a reset.

By default, the beginning counter value is zero whether for UP or DOWN. Only the Process-A and Process-B can make use of OFFSET value.

In a reset, the totalizer doesn't increase with the offset value. The totalizer accumulates the input pulses (multiplied by a factor) independently what is the action on process display. It is not affected by the quantities added to the main display not generated by the input pulses, that is to say, it has been added by a "reset-to-preset" or using "load" function (manual setting of display value).

Reset of the OFFSET

Simultaneously use of "RESET" and "OFFSET" key resets the OFFSET value.

To erase **OFFSET** value from process A and/or process B variables, the instrument should be showing the value corresponding to this variable on main display but,

NOT IN THE "VISUAL" ROUTINE.

Follow this method:

4. If the instrument was in the "VISUAL" routine, wait until the variable annunciator disappears (**have to be numerical value for both displays.**)
5. Press "RESET" and holding it, press "OFFSET".
6. First release "OFFSET" and then "RESET"

The TARE LED switches off once finished the operation.

LIMIT KEY

Shows cyclicly, at every press, the setpoint values.

If the setpoint is related to a PROCESS variable or BATCH, it's value appears on main display while on the auxiliary is shown which setpoint number is used.

If the setpoint is related to a TOTAL, it's value will be shown on auxiliary display and on the main display which setpoint number is used.

After 5s without using a key, the instrument comes back automatically to the run mode.

RESET KEY

Reset to zero (or to a preset value) the selected variable during VISUAL routine (see "VISUAL KEY").

During normal working, that is to say, out of this routine, the reset has no effect.

The reset is momentary action, allowing to the counter follows its functions nevertheless the key is hold down.

ENTER KEY

A momentary press allows to access to programming mode. Hold 3 seconds accesses to keyboard functions and program lock-out.

VISUAL KEY

One press shows on secondary displays the corresponding indication of the variable present on main display.

After 5s disappears the indication and the meter goes out from visualization mode.

If before to finish the 5 seconds, press the VISUAL key, will be visualized the next variable if it exist.

Only one press on VISUAL key shows only the variable present on display, doesn't change it.

On visualization cycle will only appear the active variables, that is to say, if the batch function is not active it does not appear or if the counter is only one channel, channels B and C do not appear.

VISUAL + ENTER KEYS

If during the indication of main variable indication press "ENTER" key, the VISUAL routine will show the total values on secondary display.

(Pressing "ENTER", the actual variable on main display will remain like default variable).

VISUALIZATION VARIABLES ON AUXILIARY DISPLAY

To show on auxiliary display the variables process or batch instead total, is necessary to activate the logical function Nr 27 (see page 45, blank auxiliary display), that blanks auxiliary display when is used like totalizer display.

This function is useful when needed to have simultaneous indication of process value and number of batch, or process value of each channel, and always is possible to see the total getting the visual routine.

With Nr 27 logical function activated, push VISUAL key to enter into routine of variables's visualization. Push once again to change the variable on main display (only will show the process and batch variables activated according programming)

Next, push ENTER to select the auxiliary display variables.

Pushing repeatedly the VISUAL key, will appear all the activated variables including process, batch and totals.

If a process or batch value has been selected, this will remain fixed on the auxiliary display as long as the function Nr27 is active. (when deactivated, pass to show the total A). If a total value is selected the display will blank and only can show the total getting the VISUAL routine.

NOTES:

-The LOAD function (programming of initial value of any variable), doesn't work on auxiliary display with process or batch variables. To load a specific value for this variables should be done from the main display, automatically will be reflected on auxiliary display, after that is necessary to select the variable of main display since will remain the loaded with a new value.

-A request through serial channel, will send the variable on this auxiliary display , be process, batch or total.

Function LOAD

The LOAD function allows to introduce by key an initial counting value into anyone display. This value is loaded as an actual counting value and it's not stored for future uses.

During the VISUAL routine, when the variable we would like to modify is on display, press "ENTER" key during 3 seconds, at the end of this 3 seconds, the first left digit or the sign led go to blink.

The programming of the value is done in an standard way and at the end, a press on "ENTER" key allows to exit from this programming step, following the VISUAL routine to the next step.

The programmed value is loaded into the selected variable when press "ENTER" key, beginning the counting from this point.

6.2. Programmable logical functions on rear connector

6.2.1. Wiring

The rear connector CN2 provides 4 user programmable opto-coupled inputs that can be operated from external contacts or logic levels supplied by an electronic system. Four different functions may be then added to the functions available from the front-panel keys. Each function is associated to one of the CN2 connector pins (PIN 1, PIN 2, PIN 4 and PIN 5) and is activated by applying a falling edge or a low level pulse to the corresponding pin with respect to common (PIN 3).

Each pin can be assigned to one of the 26 functions listed on the following pages.

CN2 : DEFAULT CONFIGURATION:

INPUT PIN	FUNCTION	Nr FUNC.
INPUT 1	Visualization variables	1
INPUT 2	Hold of display	2
INPUT 4	Reset counter	6
INPUT 5	Reset totalizer	7

PIN 3 = COMMON

The external electronics (fig.43.2) applied to the CN2 connector must be capable of withstanding 40 V and 20 mA present at all terminals with respect to COMMON. In order to guarantee the electromagnetic compatibility, please refer to the instructions given on page 10.

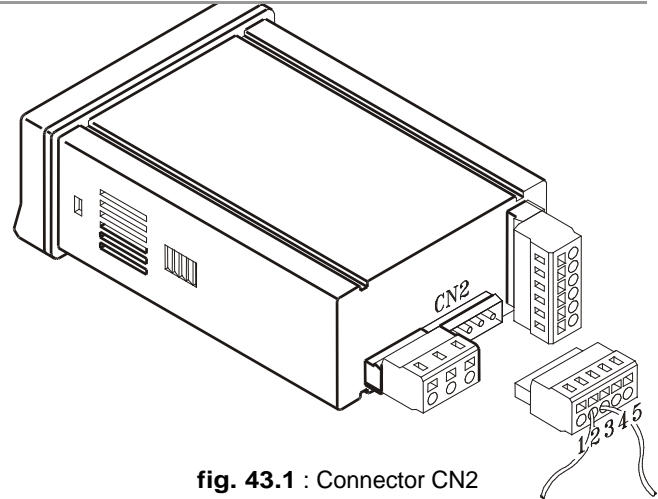

fig. 43.1 : Connector CN2

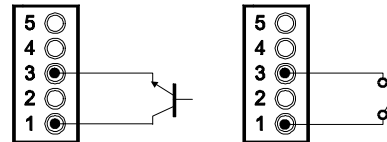

fig. 43.2 : Wiring examples.

From left to right, electronic device, closure switch.

6.2.2. Table of programmable functions

Definition of ACTION column

Pulsation :The function is active applying a negative edge to the corresponding pin referred to common.

Level : The function will be active as long as the corresponding pin is low referred to common.

Definition of group 1 and group 2

The functions that mean a reset (**except** RESET TOTAL) or printing one or several variables allow to program which variables will be affected (see diagram).

There are two groups of variables associated to reset function and two groups more associated to printing.

Nr	FUNCTION	DESCRIPTION	ACTION
0	Deactivated	None	-
1	VISUAL	Cyclical visualization of process variables, batch and total of every channel with their corresponding annunciator. It's similar to the function "VISUAL" by key except for not use of "ENTER" key to go to visualize the totals that follow the rest of variables.	Pulsation
2	HOLD1	Hold main and secondary display.	Level
3	HOLD2	Hold the main and secondary display, analog output and the display values that in this moment could be sent through serial channel.	Level
4	HOLD1 + RESET1	Reset to the preset value the variables programmed YES on group 1 holding the display value until a new hold1 + reset1 (all internal functions of the counter will follow working).	Pulsation
5	HOLD2 + RESET1	Reset to the preset value the variables programmed YES on group 1 holding the display value , analog output and RS output hold until a new hold2 + reset1 (counting and setpoints functions will follow internally working).	Pulsation
6	RESET1	Reset to the preset value the variables programmed YES on group 1	Pulsation
7	RESET2	Reset to the preset value the variables programmed YES on group 2	Pulsation

Nr	FUNCTION	DESCRIPTION	ACTION
8	STOP + RESET1	Stop all counters while the function is active, and upon deactivate the function resets to the preset value the variables programmed YES on group 1 following counting from this value.	Level
9	STOP + RESET 2	Idem function 8 but resets the variables of group 2.	Level
10	RESET TOTAL	Resets all variables TO ZERO and deactivates all setpoints included LATCH-2 except for which on zero condition should be actives.	Pulsation
11	INHIBIT A	Inhibits input A as long as the function is activated.	Level
12	INHIBIT B	Inhibits input B as long as the function is activated.	Level
13	INHIBIT BATCH A	Inhibits the function BATCH RESET of channel A, that is to say, doesn't increase the variable BATCH A on a reset of PROCESS value.	Level
14	INHIBIT BATCH B	Inhibits the function BATCH RESET of channel B, that is to say, doesn't increase the variable BATCH A on a reset of PROCESS value.	Level
15	OFFSET	Takes the value of process A or process B (if this is showed on main display) as value of preset A or preset B)	Pulsation
16	RESET OFFSET	Resets the value of preset A or preset B (if the process A or process B respectively are on main display)	Pulsation
17	PRINT 1	Print the variables and total programmed "YES" on group 1	Pulsation
18	PRINT 2	Print the variables programmed "YES" on group 2	Pulsation
19	PRINT SET1	Print setpoint 1 and its state	Pulsation
20	PRINT SET2	Print setpoint 2 and its state	Pulsation
21	PRINT SET3	Print setpoint 3 and its state	Pulsation
22	PRINT SET4	Print setpoint 4 and its state	Pulsation
23	ZERO ANA	Takes the analog output to zero condition (0V or 4mA according type)	Level
24	RESET LATCH	Unlock outputs of setpoint latch-2 and, if the alarm condition disappeared they are deactivated.	Pulsation
25	HOLD SETPOINTS	Inhibits comparison with setpoints while the function is active.	Level
26	FALSE SETPOINTS	Allows programming and use of 4 setpoints when there is no output card plugged in, as long as the function is active.	Level
27	SWITCH OFF AUX. DISP.	Switch off the auxiliary display	Level

6.2.3. Programming of logical functions

DIAGRAM

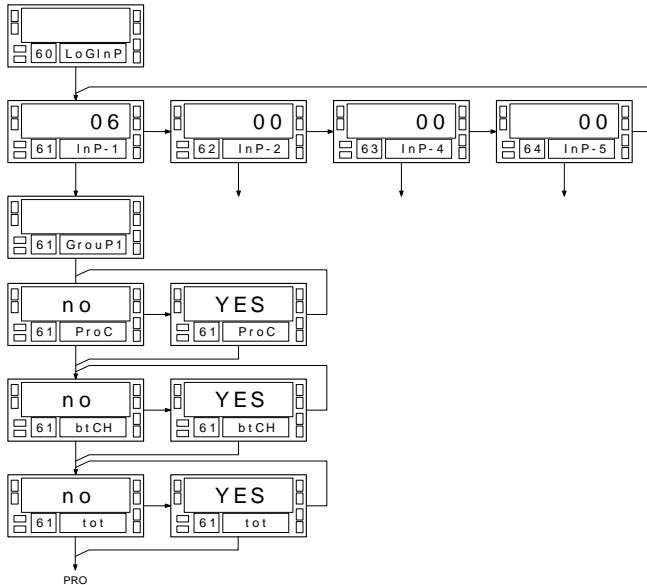

The logical functions are programmed on module '60 LoGInP'. There are 4 menus each one of them corresponds to an input of connector CN2 :

61 InP-1 : Input pin 1

62 InP-2 : Input pin 2

63 InP-4 : Input pin 4

64 InP-5 : Input pin 5

The pin 3 is the common.

On each menu is selected a number from 0 to 26 according to the desired function.

To change the number, press repeatedly the  key.

To program the next input, press .

On the left diagram is shown the whole programming module where can see that after the function number is possible to select the variable affected by this function.

6.3. Programming and keyboard functions lockout

The instrument is supplied with all software programming parameters accessible to operator's modifications. After completing the software configuration, it is recommended to take the following steps:

1. Lockout programming parameters to prevent from accidental or unauthorized modifications.
2. Lockout keyboard functions to prevent from accidental or unauthorized modifications.
3. The access to the lockout routine is allowed by entering a safety code. At factory this code is set to 0000. We recommend to change this code and to write it down and keep safe.
4. The access to the lockout routine is allowed by entering a safety code. At factory this code is set to **0000**. We recommend to change this code and to write it down and keep safe.

TOTAL LOCKOUT

The access to the programming routines to read data is allowed even if all parameters are locked out, but **it won't be possible to enter or modify data**. In this case, when entering in the programming mode, the second display shows the indication -dAtA- instead of -Pro-.

SELECTIVE LOCKS

When only some parameters are locked out, all configuration data can be read but **only non-protected parameters can be modified**. In such case, when entering in the programming mode, the second display shows the indication -Pro-.

KEYBOARD FUNCTION'S LOCKOUT

All keyboard functions in RUN mode except setpoint visualization values, should be inhibit independently by software.

The diagram shows all phases of the lockout routine which allows to lockout the programming parameters and to change the safety code. The access to this routine is accomplished by holding **ENTER** for approximately 3s until the indication "CodE" appears on the second display.

The unit is shipped from the factory with a safety code of **"0000"**. Once introduced this code, you are asked to select whether to change it or to enter directly in the parameter lockout list.

If you decide to change the default code, after programming the new one, the instrument returns to the run mode. You will be asked to enter the new code before trying to access the lockout routine for the next time.

If you decide not to change the safety code, the next step ('tot-LC') allows to lock everything and return to the run mode (set digit to 1) or to access the list of parameters which can be locked individually (set tot-LC to 0).

Meaning of menus ('1' locked, '0' unlocked) :

- **tot-LC** : total lock
- **Set1, Set2, Set3, Set4** : individual lock of setpoints
- **InPUt** : Lock of Input module
- **dISP** : Lock of Display module
- **AnAout** : Lock of analog output option module
- **rS CoM** : Lock of serial output option
- **SP VAL** : Lock of direct access of programming setpoints
- **RESEt**: Inhibit the reset function.
- **OFFSEt**: Inhibit the offset function and reset of offset
- **LoAd**: Inhibit the introduction of values of counter by keyboard during "VISUAL" routine.

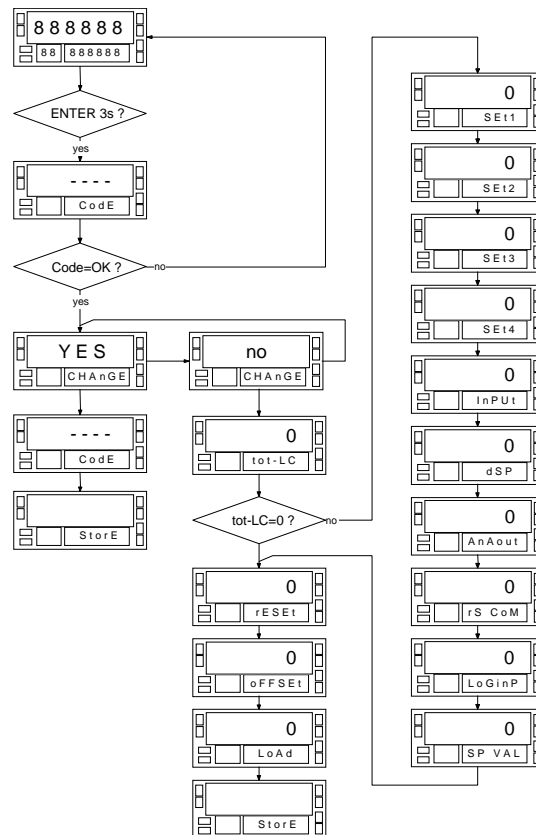

7. SPECIFICATIONS

Index

SECTION	
7.1. Output Options	50-51
7.2. Technical characteristics	52-53
7.3. Dimensions and mounting	54
7.4. Warranty	55
7.5. Certificate of conformity	57

6.1. OUTPUT OPTIONS

Optionally, model BETA-M can incorporate one or several output options for communications or control including :

COMMUNICATION

RS2	Serial RS232C
RS4	Serial RS485

CONTROL

ANA	Analogue 4-20 mA, 0-10 V
2RE	2 SPDT relays 8 A
4RE	4 SPST relays 0.2 A
4OP	4 open-collector NPN outputs
4OPP	4 open-collector PNP outputs

All options are opto-isolated with respect to the input signal and the main supply.

The options are supplied with a specific instructions manual describing characteristics, installation, connections and programming. The output cards are easily installed on the meter's main board by means of plug-in connectors and each one activates its own programming module that provides complete software configuration.

Additional capabilities of the unit with output options :

- Control and processing of limit values via ON/OFF logic outputs (2 relays, 4 relays, 4 NPN outputs or 4 PNP outputs) or proportional output (4-20 mA or 0-10 V).
- Communication, data transmission and remote programming via serial interface.

For more detailed information on characteristics, applications, mounting and programming, please refer to the specific manual supplied with each option.

Drawing on the right shows how to plug-in different output options.

The options 2RE, 4RE , 4OP and 4OPP are excluding and only accepts one into connector M5.

The options RS2 y RS4 are also excluding and only accepts one into connector M1

The ANA analog option is plugged in connector M4.

Can be plugged-in and working simultaneously up to 3 options:

- one analog (ref. ANA),
- one RS232C (ref. RS2) or RS485 (ref. RS4).
- one 2 relay (ref. 2RE) ó 4 relay (ref. 4RE) or 4 optos NPN (ref. 4OP) or 4 optos PNP (ref. 4OPP).

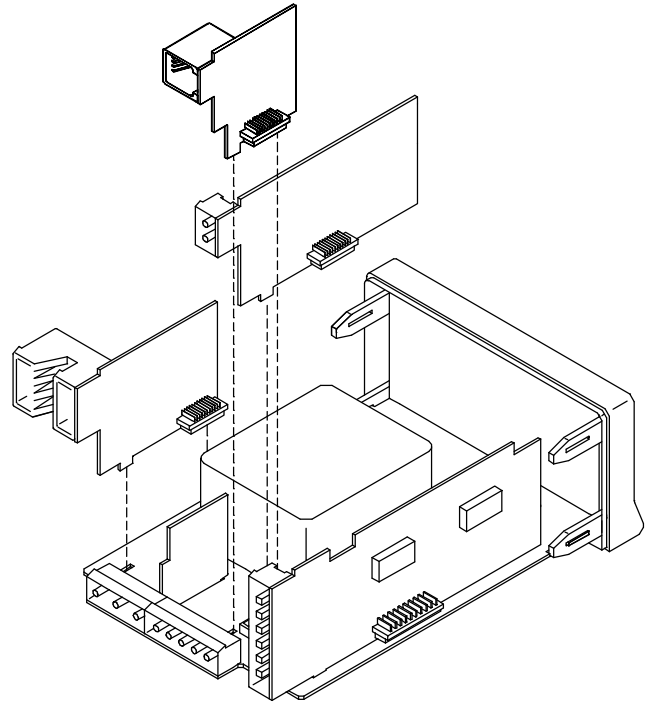

7.2. Technical Characteristics

INPUT SIGNAL

- Sensor excitation 8V/24V DC @ 30mA
- Minimum frequency like tachometer.....0.02Hz
.....20 ±5 Vdc @ 60mA (Max environmental temp. 50°C)

Table of maximum frequencies :

Configuration	No Options	n 4 setpoints	4 setps+analog+rs
Counter			
1 input, 1 edge	13 KHz	9,5 KHz	7,5 KHz
1 input, 2 edges	8 KHz	5,5 KHz	4,5 KHz
2 inputs, 1 edge	6 KHz	4,5 KHz	3,5 KHz
2 inputs, 2 edges	4 KHz	3 KHz	2 KHz
Tachometer			
1 input, 1 edge	12 KHz	9 KHz	7 KHz
1 input, 2 edges	9 KHz	6 KHz	5 KHz
2 inputs, 1 edge	7 KHz	5 KHz	4 KHz
2 inputs, 2 edges	5 KHz	3 KHz	2 KHz

MAGNETIC PICKUP

- Sensitivity $V_{in} (AC) > 120mV_{eff}$

NAMUR SENSOR

- R_c 1K (included)
- I_{on} < 1mA DC
- I_{off} >3mA DC

TTL/24V DC (ENCODER)

- logical levels..... "0" < 2.4V DC, "1" > 2.6V DC

SENSOR TYPE NPN ó PNP

- R_c 1K (included)
- logical levels "0" < 2.4V DC, "1" > 2.6V DC

SWITCH CONTACTS

- V_c5V
- R_c 3.9K
- F_c 100Hz

FUSES (DIN 41661) - Not supplied

- Beta-D (230/115V AC)F 0.2 A / 250 V
- Beta-D2 (24/48V AC)F 0.5 A / 250 V

POWER SUPPLY

- AC voltages230/115 V, 24/48 V ($\pm 10\%$) 50/60 Hz AC
- Consumption 5W (no options), 10W (maximum)

DISPLAY

- Rate 100/s
- Main -999999/ +999999, 6, 14mm red digits
- Secondary -9999999/99999999, 8, 8mm green digits
- Decimal pointprogrammable 6 positions
- LED's 4 for functions and 4 for outputs
- Positive over range oVEr
- Negative over range -oVEr

ACCURACY

- Tachometer accuracy $\pm(0.01\%$ of reading + 1 digit)
- Temperature coefficient 100ppm/ $^{\circ}$ C
- Warm-up time 10 minutes

ENVIRONMENTAL

- Indoor use
- Operating temp. -10 $^{\circ}$ C to 60 $^{\circ}$ C
- Storage Temperature Range -25 $^{\circ}$ C a +85 $^{\circ}$ C
- Humidity (operating and storage) < 95% at 40 $^{\circ}$ C
- AltitudeUp to 2000m

MECHANICAL

- Dimensions96x48x120mm (DIN 43700)
- Panel cutout 92x45mm
- Weight 600g
- Case material Polycarbonate (UL 94 V-0)
- Front Sealed IP65

7.3. Dimensions and mounting

To install the instrument into the panel, make a 92x45 mm cutout. Slide the sealing gasket over the rear of the unit and insert the unit into the panel from the front.

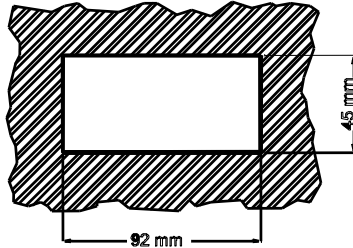

Place the fixing clips on both sides of the case and slide them over the guide tracks until they touch the panel at the rear side.

Press slightly to fasten the bezel to the panel and secure the clips in the slots of the case.

To take the instrument out of the panel, pull outwards the rear tabs of the fixing clips to disengage and slide them back over the case.

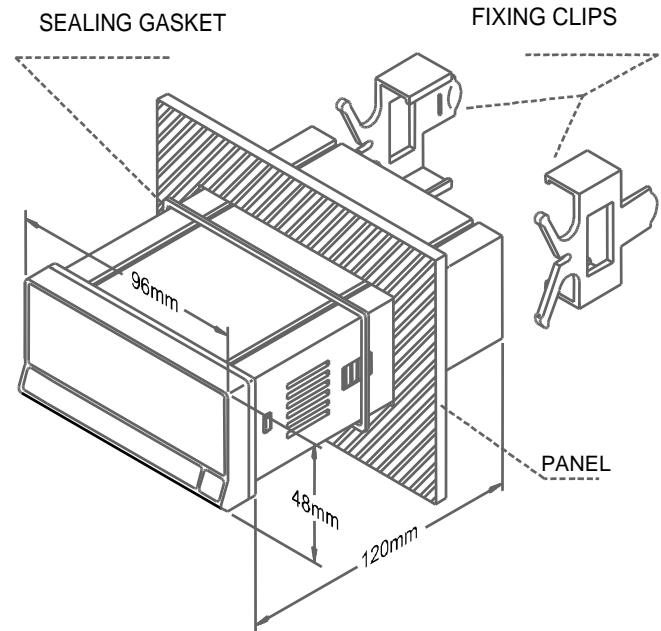

7.5. CERTIFICATE OF CONFORMITY

Manufacturer : DITEL - Diseños y Tecnología S.A.

Address : Travessera de les Corts, 180
08028 Barcelona
ESPAÑA

Declares, that the product :

Description : Digital panel multifunction meter

Model : **BETA-D**

Conforms with the directives : EMC 89/336/CEE
LVD 73/23/CEE

Applicable Standards : **EN50081-1** Generic emission
EN55022/CISPR22 Class B

Applicable Standards : **EN50082-1** Generic immunity
IEC1000-4-2 Level 3 Criteria B
Air Discharge 8kV
Contact Discharge 6kV

IEC1000-4-3 Level 2 Criteria A
3V/m 80..1000MHz

IEC1000-4-4 Level 2 Criteria B
1kV Power Lines
0.5kV Signal Lines

Applicable Standars : **EN61010-1** Generic Safety
IEC1010-1 Installation Category II
Transient Voltages <2.5kV
Pollution Degree 2
Conductive pollution excluded
Insulation Type
Enclosure : Double

Date: 8 March 2001
Signed: José M. Edo
Charge: Technical Manager





INSTRUCTIONS FOR THE RECYCLING

This electronic instrument is covered by the **2002/96/CE** European Directive so, it is properly marked with the crossed-out wheeled bin symbol that makes reference to the selective collection for electrical and electronic equipment which indicates that at the end of its lifetime, the final user cannot dispose of it as unsorted municipal waste.

In order to protect the environment and in agreement with the European legislation regarding waste of electrical and electronic equipments from products put on the market after 13 August 2005, the user can give it back, without any cost, to the place where it was acquired to proceed to its controlled treatment and recycling.

DISEÑOS Y TECNOLOGIA, S.A.

Polígono Industrial Les Guixeres

C/ Xarol 8 C

08915 BADALONA-SPAIN

Tel : +34 - 93 339 47 58

Fax : +34 - 93 490 31 45

E-mail : dtl@ditel.es

www.ditel.es

KOSMOS SERIE

CODE: 30727126 EDITION: 05-09-2006



**INSTRUCTIONS MANUAL
COUNTER – TOTALIZER
TACHOMETER - TOTALIZER
PART 2 / 2**



MODEL BETA-D
PROTOCOL MODBUS-RTU COMPATIBLE



APPENDIX - INDEX

The output options are supplied in a separate way with its own instructions manual describing installation card, wiring and electrical characteristics and the general instructions for programming.

When the Tachometer option is active, this one will be the PROCESS variable (or in 3 channels case, the PROCESS variable), this is to say, the measurement of the speed

Setpoints	61
for counter	62-69
for Tachometer	70-75
Analog output	77
Serial output RS232C / RS485	79

APPENDIX A. SETPOINTS

Index

Programming and setpoints setup depends on if they are referred to the variable "pulse counter or tachometer". When the tachometer function is activated, this last will be the variable Process(or in three channel case, the variable Process-A), this is to say the momentary speed.

SECTION

Referred to the Counter

A.1. Programming diagram 62

A.2. Setpoint setup and activation 63-67

A.3. Output behavior definitions

A.3.1. Configuration 67-68

A.3.2. Operation diagram 69

Referred to the Tachometer

A.4. Programming diagram 70

A.5. Setpoint setup and activation 71-72

A.6. Output behavior definitions

A.6.1. Configurations 73-74

A.6.2. Operation diagram 75

A.1. Programming SETPOINT 1 referred to a counter (valid for the rest of setpoints)

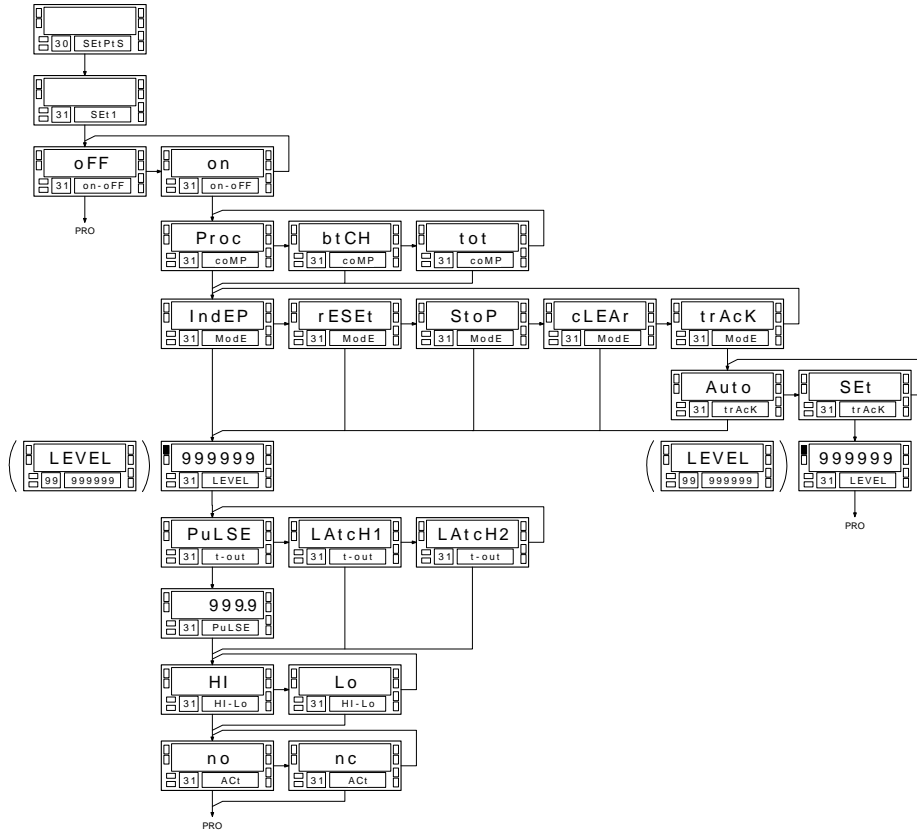

A.2. Ways of working

SELECTION ON-OFF

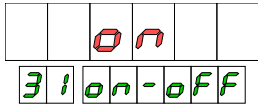

COMPARISON

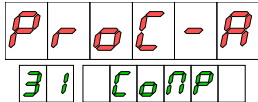

The setpoints can be referred to the PROCESS, BATCH or TOTAL variables of any channel.

When are referred to any variable of C channel, the comparison is done at the refreshing rate of this variable, this is to say, every 10ms.

FUNCTIONS

At the setpoint activation, in addition to change the output state, a specific action is done over the process that is independently programmable for every setpoint.

The action is only done on the activation edge of the output, never when the alarm condition is already established

FUNCTIONS

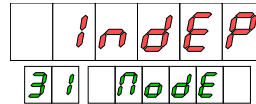

INDEP. No action is done

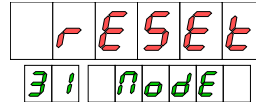

RESET. Puts to zero the variable referred by the setpoint or, if it's the PROCESS value, to the preset value. (BATCH y TOTAL have no preset, always are reset to zero).

1. In PULSE configuration the reset action is done in a cyclic way, this is to say, the relay is activated on setpoint value resetting the counter and deactivating at the end of programmed time. The operation is done again at every reached of setpoint value as long as the activation time of relay doesn't be longer than the time to pass again through the setpoint.

2. In LATCH1 or LATCH2 configuration the relay activation time should be minimum putting the counter to zero and deactivating the relay immediately, this should be taken into account when using this configurations.

	S	t	o	p
3	:	n	o	d

STOP. Stops the counter. All counter variables are hold , not only what is related to the setpoint.

1. In PULSE mode the counts stops only during the activation time programmed, after that follows runing.

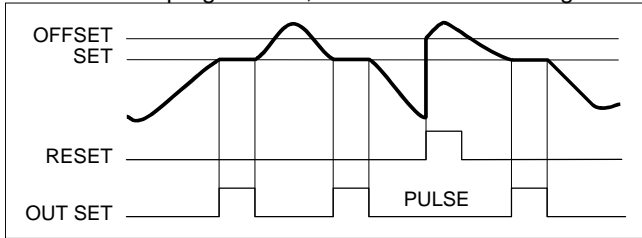

2. In LATCH1 y LATCH2 mode se para el contador definitivamente y sólo reanuda la marcha cuando se realiza un reset del contador. El contador arranca en el valor cero de offset.

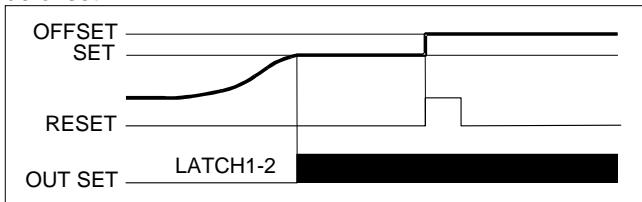

	C	L	E	A	R
3	:	n	o	d	

CLEAR. Deactivates the previous relay if is active at the moment of this action. The previous setpoint for number 1 is number 4.

If the previous setpoint is not active when occurs the action, this will activate in a normal way when reach the condition.

1. In PULSE configuration the deactivated relay comes back to be active, if it's corresponding, once the programmed activation time for this relay has finished

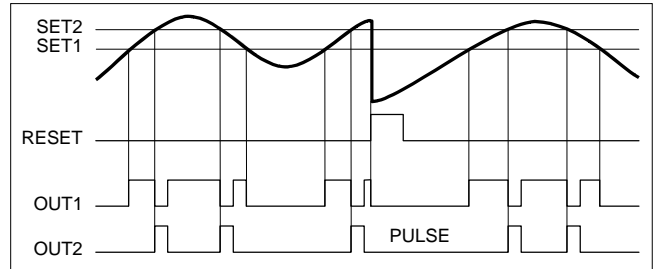

2. En la configuración LATCH1 el relé desactivado vuelve a activarse, si corresponde, cuando cesa la condición de activación del relé que efectúa la acción.

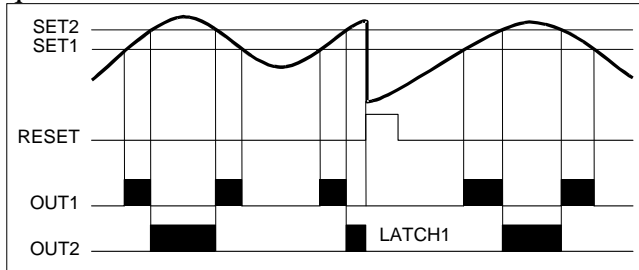

3. En la configuración LATCH2 el relé desactivado queda permanentemente en este estado. Sólo podrá volver a activarse, si corresponde, en un reset que desenclave el relé que efectúa la acción.

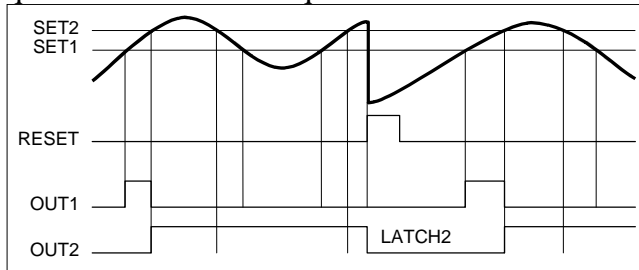

	t	r	A	C	H
3	!	n	o	d	E

	A	u	t	o	
3	!	n	o	d	E

TRACK AUTO. There is used to fit of automatic form the quantity that, in a system of dosing, is programmed as limit to give the order of cutting the flow of material. It is necessary reset the display in every measurement (if the setpoint is programmed in mode pulse) the reset will do of automatic form). The accumulated whole is indicated in the auxiliary display and, if is selected the function BATCH RESET, the number of realized measurements will be accumulated in the variable BATCH.

1. To programme the setpoint in way PULSE allows to realize this action of automatic form calculating the approximate time that is late in the display to be established since the setpoint is reached until stops the process. This time, or slightly large, will be programmed as time of activation of the relay impulsional.

2. Programming the setpoint in way LATCH the action is realized manually by the operator providing a reset as soon as the display has become stable. In mode PULSE, it is necessary to have the precaution of the setpoint programmes in way "LO" in order that the relay is activated, instead of be deactivating, after the time of programmed impulse since the function is realized in the activation.

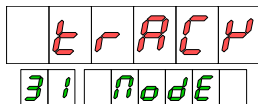

TRACK SET. It is used as pre-alarm of the setpoint that precedes in number. The setpoint that precedes the number 1 is the number 4.

The value of setpoint that is programmed in this case is the distance in points with regard to the value of setpoint precedent.

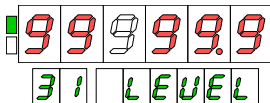

The value of display in which the output will be activated is the value of the previous setpoint minus the programmed value like track set. If it was negative, the output would be activated in the value of the previous setpoint added with the track set.

The parameters of functioning will be those of the main setpoint.

We suppose that one machine that wraps reels of thread, have to cut and seal the reels every 100.0 meters of thread and that before, in order that these operations can be realized, is necessary to reduce the speed of the rollers, for example when a 5.0 meters lack to complete the process.

This application might be realized programming the setpoint 1 of value 100.0 and the setpoint 2 with function TRACK SET of value 5.0.

The output of the setpoint will take charge of the maneuver of speed reduction of the machine (being activated when the display coming to 95.0) and the output of the setpoint will take charge of the maneuver of cutting and sealing when the display to come to 100.0.

SET1 = 100.0 (with function TRACK AUTO and way PULSE, the reset would be automatic on having come to 100.0).

SETPOINT VALUE

The setpoint value are programmed on the whole range of display, with polarity and with the decimal point on the same position that the variable are referred.

When is referred to a PROCESS variable or BATCH, its value is programmed with 6 digits on main display.

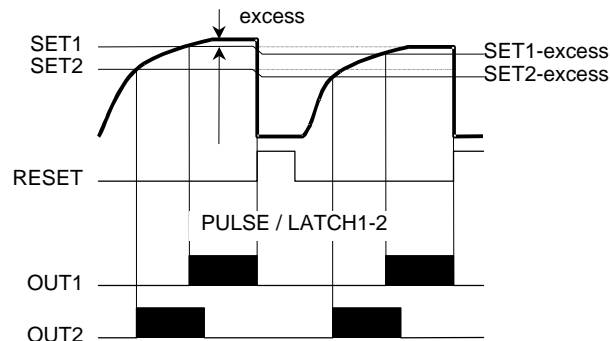

SET1 = 100.0 (with function TRACK AUTO and way PULSE, the reset would be automatic on having come to 100.0)

SETPOINT'S VALUE

The values of setpoint are programmed in the whole range of display, with sign and with the decimal point in the position of the variable to which they refer.

When is referred to the PROCESS or BATCH , its value is programmed with 6 digits in the main display.

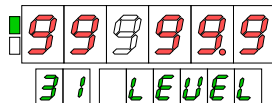

When it is referring to a TOTAL variable, its value is programmed with 8 digits in the secondary display. The first digit can be a number of 0 to 9 or one negative sign.

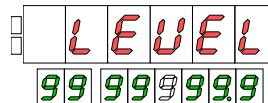

A.3. Output configuration

A.3.1. Configurations Pulse, Latch, HI-LO, NO-NC

ACTIVATION TIME

The activation of an alarm of setpoint takes place in the moment in which the display reaches the programmed value.

The state of alert disappears, according to programming, of three different ways;

PULSE(deactivation after a programmed time),

LATCH1 (deactivation when stops the condition of alarm) and

LATCH2 (deactivation when a reset is done)

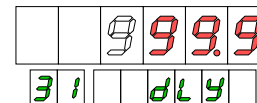

PULSE

Activation when the display reaches the value of setpoint already is in ascending (rising) or descending sense.

The relay is not activated when in the connection of the device or after a special action (reset, load) the display takes the value of the setpoint.

Deactivation after the time of programmed impulse.

(Programmable from 0.1 to 999.9 seconds).

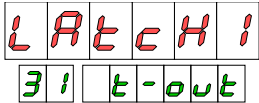

LATCH1

Activation when the display is in a value that overcomes the value of setpoint.

Deactivation when the display goes on to a value below the value of setpoint.

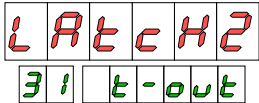

LATCH2

Activation when the display is in a value that overcomes the value of setpoint.

Interlock in the flank of activation of the relay, NOT when the condition of alarm is established, in which case is activated but it is not latched.

De-interlock. Once activated and latched it will not be deactivated when the condition of alarm stops but yes from a reset of the variable to which it is referred providing that the new value of display is not in condition of alarm, in which case will be deactivated neither the relay nor unlatch.

Deactivation. The form of de-interlocking a relay without reset the counter is to use the logical function n^o 24 (reset relays latch), that de-interlock all the relays and deactivates those who are not in condition of alarm.

MODE HI-LO

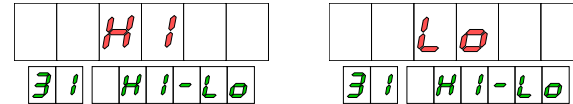

In mode **HI** the output is activated when the display is equal or greater than the value of setpoint and is deactivated when it is less.

In mode **LO** the output is deactivated when the display is equal or greater than the value of setpoint and is activated when it is less.

MODE NO-NC

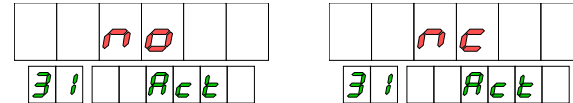

NOT (normally open) it means that the output of setpoint will be deactivated in normal condition and activated in of alarm's condition.

NC (normally closed) means that the output of setpoint will be activated in normal condition and will be deactivated when it reaches the condition of alarm.

A.3.2. Summary diagram of ways of working

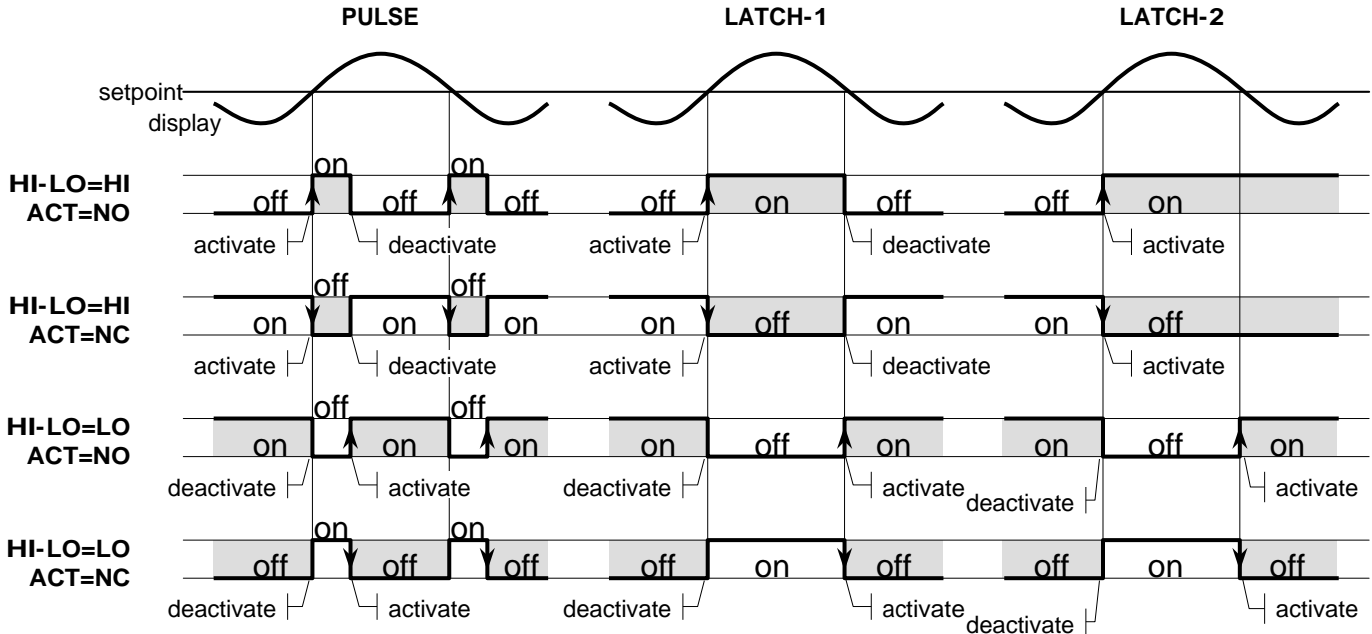

▲ : Activation edge of alarm where are done the setpoint functions (RESET, STOP, etc...) and where the relays make LATCH2

■ : Alarm zone

ON : Relay and LED activated. **OFF** : Relay and LED deactivated.

A.4. Programming setpoint 1 referred to the tachometer (rest of setpoints the same)

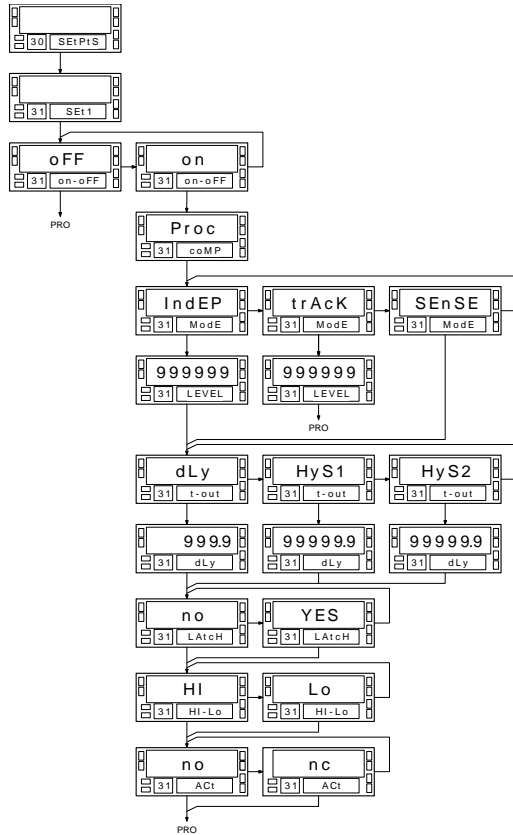

A.5. Working ways

SELECTION ON-OFF

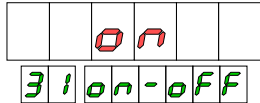

COMPARISON

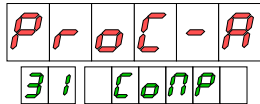

If is wanted to refer one o more setpoints to the instantaneous speed, the variable of comparison will have to be PROCESS or, in case of 3 channels PROCESS-A.

SPECIAL FUNCTIONS

The setpoint referred to speed can have three specific functions on the process such as control of value limit (INDEP), pre-alarm or safety alarm (TRACK) and indication of sense of rotation (SENSE).

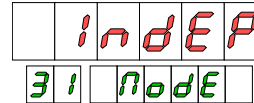

INDEP. In independent way, a value is programmed of display above or below which the alarm will be activated. The value of setpoint corresponds to an instantaneous speed and does not have sign.

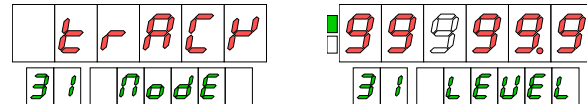

TRACK. It is used as pre-alarm or safety alarm of the setpoint that precedes in number. The setpoint that precedes the number 1 is the number 4.

The value to programming is the distance in points with regard to the value of setpoint precedent.

The value of display in which the output will be activated is the value of the previous setpoint fewer value programmed like track.

If it was negative, the output would be activated in the value of the previous setpoint more of track set.

The parameters of functioning are not programmed but they take directly of those of the main setpoint.

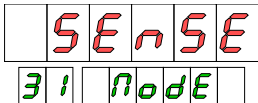

SENSE. In mode SENSE, the setpoint is not referred to the speed but to the sense of rotation. **The condition of alarm takes place when the sense is negative.** That the output is activated or not will come determined by the parameters HI-LO and NO-NC.

The sense of rotation determines the direction of count of the totalizer associated with the channel A, for that only the configurations in which the channel A can count and discount can indicate variation of sense.

These they are: 1 channel, modes 'up-do', 'dir', 'PH1', 'PH2' and 'PH4'.

SETPOINT VALUE

The values of setpoint for tachometer are referred to the variable PROCESS A and are programmed without sign and with the same decimal point that has this variable.

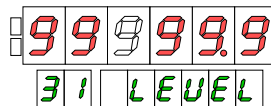

Depending on the setpoint function previously selected, the programming of this value will be done of the following ways:

IndEP: is programmed the value of display where the alarm must be activated.

TrAck: is programmed of the number of points of display for below or over the previous setpoint in which there is activated the alarm used as pre-alarm or safety alarm.

SenSE: no value is programmed.

A.6.1. Output mode definition (delay-hysteresis, latch, hi-lo, no-nc)

RANGE OF ACTIVATION

There are three ways of activating the setpoint output:

		d	L	y		
3	!	t	-	o	u	t

		9	9	9	.	9	9	9
3	!			d	L	y		

		H	Y	S	2			
3	!			t	-	o	u	t

9	9	9	.	9	9			
3	!			d	L	y		

DLY. In way 'dly' delay, the output is activated with a programmable delay when the condition of alarm having taken place and maintained, is deactivated with the same delay on having eliminated the condition of alarm.

The time of delay is programmable of 0.1s to 999.9s

		H	Y	S	!			
3	!			t	-	o	u	t

9	9	9	.	9	9	9	9	9
3	!			d	L	y		

HYS1. In way 'hys1' (hysteresis asymmetric) the output is activated in the value of setpoint and a programmable number of points is deactivated below the setpoint.

The level of hysteresis is programmable in the whole range of the display (0 to 999999) with the decimal point in the position of the display.

HYS2. In way 'hys2' (hysteresis symmetrical), the output is activated a programmable number of points below the setpoint and the same number of points is deactivated over the setpoint.

The number of points is programmable of 0 to 999999 with the decimal point in the position of the display. The value to programming will be the half of the total margin of hysteresis, that is to say, supposing that the value of setpoint was 1000 and the value programmed of hysteresis-2 was 100, the range of display in that the alarm would be activated between 900 and 1100.

LATCH

The function latch is applied when it is necessary to keep an alarm activated still when the condition of activation has disappeared. For example to know if, at the conclusion of a cycle of measurement, the process has exceeded in some moment a value limit.

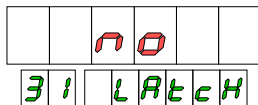

no does't latch the output

YES Latch the output on the activation edge

When there is selected the option 'YES', the output of setpoint is activated when the display reaches the programmed value and it will not be deactivated any more than in a disconnection of the device or by means of the logical function 26 (in rear conector).

The output is activated but it is not latched if on having connected the instrument, the display has a value that is in condition of alarm. The latch takes place only in the edge of activation of the output in a step along the setpoint.

MODE HI-LO

In way **HI** the output is activated when the display is equal or greater than the value of setpoint and is deactivated when it is less.

In way **LO** the output is deactivated when the display is equal or greater than the value of setpoint and is activated when it is less.

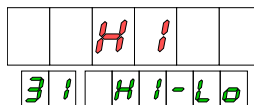

MODE NO-NC

NOT (normally open) it means that the output of setpoint will be deactivated in rest and activated in condition of alarm.

NC (normally closed) means that the output of setpoint will be activated in rest and will be deactivated when it reaches the condition of alarm.

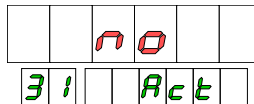

A.6.2. Summary diagram of ways of working

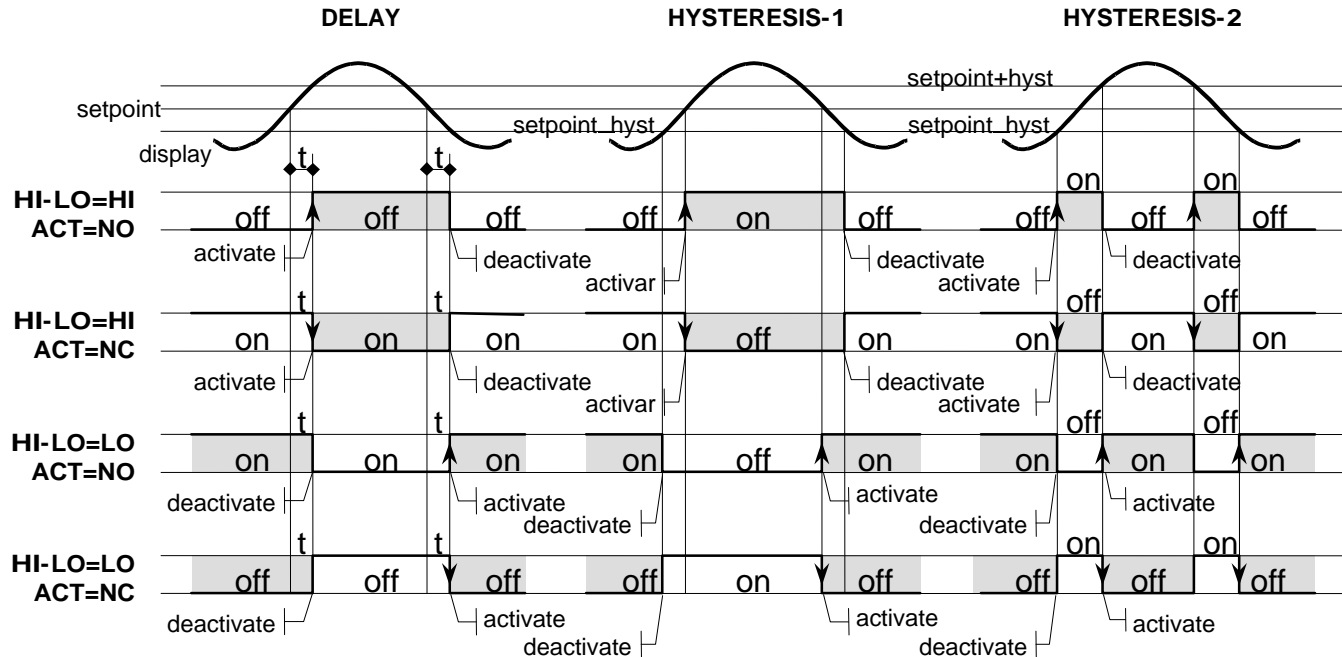

▲ : Activation edge of alarm where are done the setpoint functions (RESET, STOP, etc...) and where the relays make LATCH2
 □ : Alarm zone

ON : Relay and LED activated. **OFF** : Relay and LED deactivated.

APPENDIX B. ANALOG OUTPUT

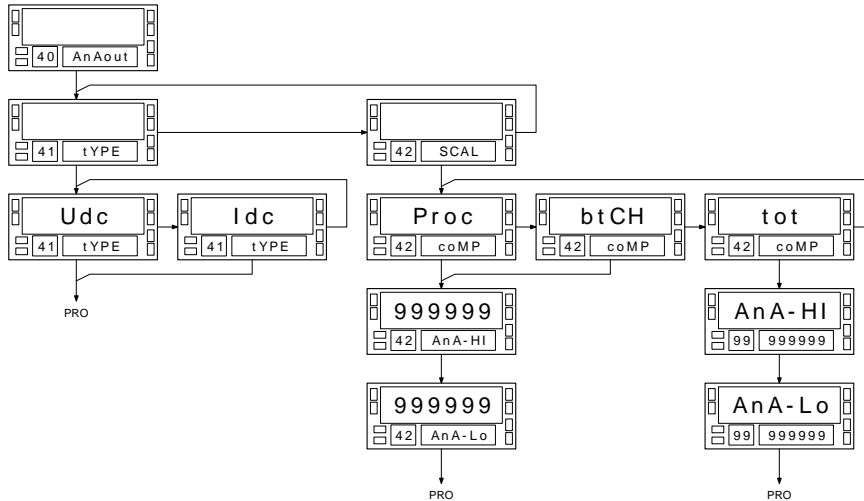

The analogical exit is updated every 10ms.
 The range of the output signal is programmed for any range of display, being able to be selected like display the PROCESS (counter or tachometer), the TOTAL or the BATCH of any of the channels (providing that above mentioned variable is enabled).

Respect of the instructions of programming that are given in the manual of the option, the menu has been eliminated 'FILTER' and the programming of the scale has been modified so that the output range to programming can refer to any variable that the instrument has enabled.
 If the variable is TOTAL, the range is programmed in the secondary display.

APPENDIX C. SERIAL OUTPUT RS232C or RS485

PROTOCOLS

It is three protocols of communication represented by the indication 'Prot-1', 'Prot-2' and 'Prot-3' that correspond to the protocols DITEL, ISO 1745 and MODBUS respectively.

AVAILABLE COMMANDS

The list of commands that is given in the manual of the option RS232C ó RS485 must be replaced by the following one:

Commands in protocol	1	2	3
hold+reset1	'h'	'0h'	'h'
reset relés latch	'n'	'0n'	'n'
reset de offset	'r'	'0r'	'r'
set offset	't'	'0t'	't'
reset1	'z'	'0z'	'z'

Data request in protocol	1	2
value of main display	'D'	'0D'
value of auxiliary display	'T'	'0T'

Data request and modification in protocol	2
send setpoint # value	'L#'
modify setpoint # value	'M#'

Request and modification of information in protocol 3

All the information contained in the memory of the instrument can be read and, if they are in a zone of allowed writing, modified in blocks of up to 250 bytes. The writing is limited to the area of information of programming of the instrument. The reading does not have limitation.

SENDING INFORMATION TO A PRINTER

Through the RS232C ó RS485 output also it is possible to realize a selective transmission of information of the instrument to a printer or a PC.

The logical functions of printing allow to realize transmissions from the instrument.

The **format of transmission** consists in:

- a character of beginning of message followed by the direction of the device,
- a line in blank,
- one or several lines containing the information according to logical programmed function
And, if it has been selected to print date and hour
- two lines in blank,
- a line with date and hour
To finish
- a line in blank

The functions of printing and how to programme them they are in the manual present in the section ' 5.2. Logical programmable functions in connector ', pages. 43 to 46.



The instruments are warranted against defective materials and workmanship for a period of three years from date of delivery.

If a product appears to have a defect or fails during the normal use within the warranty period, please contact the distributor from which you purchased the product.

This warranty does not apply to defects resulting from action of the buyer such as mishandling or improper interfacing.

The liability under this warranty shall extend only to the repair of the instrument. No responsibility is assumed by the manufacturer for any damage which may result from its use.



All the DITEL products benefit from an unlimited and unconditional warranty of THREE (3) years from the date of their purchase. Now you can extend this period of warranty up to FIVE (5) years from the product commissioning, only by fulfilling a form.



INSTRUCTIONS FOR THE RECYCLING

This electronic instrument is covered by the **2002/96/CE** European Directive so, it is properly marked with the crossed-out wheeled bin symbol that makes reference to the selective collection for electrical and electronic equipment which indicates that at the end of its lifetime, the final user cannot dispose of it as unsorted municipal waste.

In order to protect the environment and in agreement with the European legislation regarding waste of electrical and electronic equipments from products put on the market after 13 August 2005, the user can give it back, without any cost, to the place where it was acquired to proceed to its controlled treatment and recycling.