

BA458C
Intrinsically safe
Panel mounting
Batch Controller
Issue 11

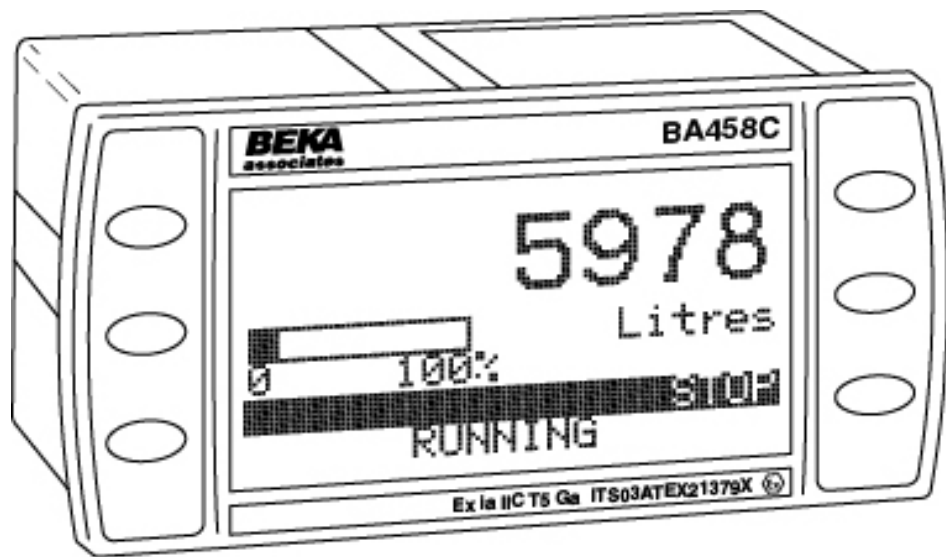

CONTENTS

1. Description	
2. Operation	
2.1 Operator controls	
2.2 Power supply failure	
3. Intrinsic Safety Certification	
3.1 ATEX certificate	
3.2 Zones, gas groups & T rating	
3.3 Power supply	
3.4 Inputs	
3.4.1 Input 1	
3.4.2 Input 2	
3.5 Switch outputs	
3.6 External switches	
3.7 Inhibit & security links	
3.8 Certification label information	
4. System Design for Hazardous Area	
4.1 System certificates	
4.2 Use with Zener barriers	
4.2.1 Power supply	
4.2.2 Pulse inputs	
4.2.2.1 Switch contact	
4.2.2.2 Proximity detector	
4.2.2.3 Voltage pulse	
4.2.3 4/20mA analogue input	
4.2.4 Switch outputs	
4.3 Use with galvanic isolators	
4.3.1 Power supply	
4.3.2 Inputs	
4.3.3 Switch outputs	
4.4 External switches	
4.5 Inhibit link	
4.6 Security link	
5. Installation	
5.1 Location	
5.2 Installation procedure	
5.3 EMC	
6. Configuration Menus	
6.1 Security	
6.2 Navigation	
6.3 Default configuration	
6.4 System settings	
6.4.1 Language	
6.4.2 User controls	
6.4.3 Signal input	
6.4.4 4mA calibration	
6.4.5 20mA calibration	
6.4.6 Lineariser	
6.4.7 Restart	
6.4.8 Output 2	
6.4.9 Output 3	
6.4.10 Optional outputs 4, 5 & 6	
6.4.11 Pulse output	
6.4.12 Clear grand total	
6.4.13 Defaults	
6.4.14 Security	
6.4.15 User screens	
6.4.16 Display	
6.4.17 Output options	
6.4.16.1 Control 2	
6.4.16.2 Control 3	
6.4.16.3 Flow alarm	
6.4.16.4 Reset status	
6.4.16.5 Batch status	
6.4.17.6 Pulse output	
6.5 Batch settings	
6.5.1 Scale Points (Non-linear pulse inputs)	
6.5.2 Scale Factors (Non-linear pulse inputs)	
6.5.3 Scale Factor (Linear pulse inputs)	
6.5.4 Scaling (4/20mA input)	
6.5.5 Batch D.P.	
6.5.6 Batch Legend	
6.5.7 Batch Limit	
6.5.8 Batch Names	
6.5.9 Batch Size	
6.5.10 Select Batch	
6.5.11 Batch History	
6.5.12 CONTROL2delay	
6.5.13 CONTROL2stop	
6.5.14 CONTROL3delay	
6.5.15 CONTROL3stop	
6.5.16 Count Mode	
6.5.17 Overrun Compensation	
6.5.18 Batch Cycles	
6.5.19 Restart Delay	
6.6 Rate settings	
6.6.1 Rate Scaling (Pulse inputs)	
6.6.2 Rate D.P. (Pulse inputs)	
6.6.3 20mA Display (4/20mA input)	
6.6.4 Rate Legend	
6.6.5 Timebase	
6.6.6 Rate Filter	
6.6.7 Flow Alarm	
6.6.8 Clip-Off	
7. Calibration Examples	
8. Maintenance	
8.1 Fault finding during commissioning	
8.2 Fault finding after commissioning	
8.3 Servicing	
8.4 Routine maintenance	
8.5 Guarantee	
8.6 Customer comments	
9. Accessories	
9.1 Tag number	
10. Index	
Appendix 1 User Screens	
Appendix 2 Diagnostic Information menu	
Appendix 3 FM & cFM Approval for use in USA & Canada.	

The BA458C is CE marked to show compliance with the European Explosive Atmospheres Directive 94/9/EC and the European EMC Directive 2004/108/EC

1. DESCRIPTION

The BA458C is a panel mounting intrinsically safe batch controller primarily intended to control the dispensing of liquids, solids or components in a hazardous area. It is a second-generation instrument that replaces both the BA350BP and the BA350BC.

Although incorporating sophisticated control functions, the BA458C is easy to operate and configure. Batch status and the function of the front panel push-buttons are shown on the backlit graphic display which is visible in all lighting conditions. The instrument can provide single, dual or three stage control and may be used with both pulse and 4/20mA analogue output flowmeters.

The BA458C has been issued with EC-Type examination certificate by Notified Body ITS which has been used to confirm compliance with the ATEX Directive 94/9/EC.

The BA458C is also FM approved for use in the USA and cFM approved for use in Canada, these approvals are described in Appendix 3.

Housed in a robust 72 x 144 panel mounting DIN enclosure, the controller has an IP66 front panel and is supplied with a gasket to seal the joint between the instrument and the panel.

2. OPERATION

Fig 1 shows a typical BA458C dispensing application. The BA458C controller incorporates programmable input scaling so that the total and rate displays may be in any engineering units such as litres or gallons.

The operator enters or selects, via the front panel push-buttons, the setpoint which is the required volume to be dispensed. Control 1 is energised immediately the *Start* push-button is operated, followed by Control 2 after a programmable time delay. Towards the end of the batch, Control 2 is de-energised a programmable volume before the batch setpoint is reached when Control 1 is also de-energised.

By operating a small bypass valve from Control 1 and the main control valve from Output 2, the flow can be started and stopped slowly thus reducing batching errors and flow surges. If less accuracy is required, single stage control can be accomplished using just Control 1 and one control valve.

Control 1 is a dedicated output, but Outputs 2 and 3 may be configured as control, pulse or batch status outputs.

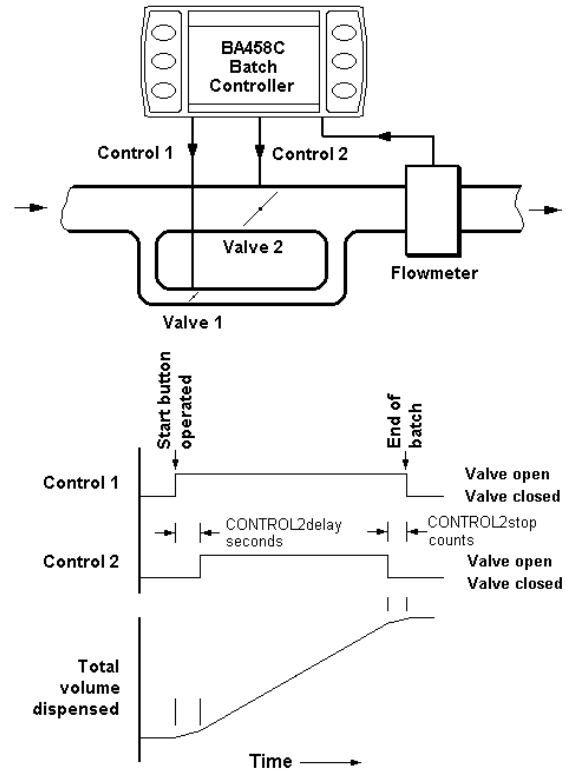

Fig 1 Typical batch control application

If additional outputs are required, three more may be added as a factory installed option.

The BA458C incorporates a selection of operator display screens allowing the installer to choose a display which only present essential information to the operator.

To prevent accidental or unauthorised adjustments, the operator and configuration menus may be protected by separate security codes. The configuration menu may also be protected by a security link connected between terminals at the rear of the instrument. This link may be hard-wired, or connected to a panel mounting key-switch when frequent changes are required.

Fig 2 shows a simplified block diagram of the controller.

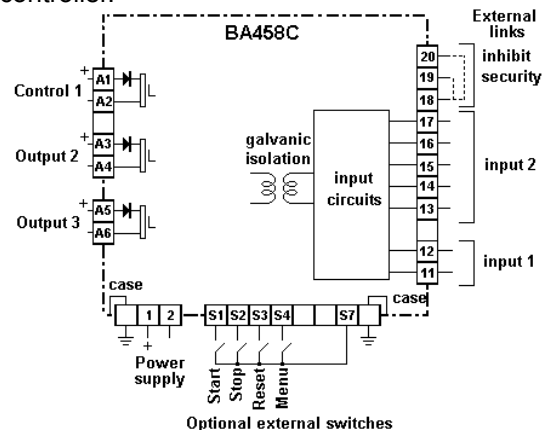

Fig 2 Simplified block diagram of BA458C

2.1 Operator Controls

The BA458C batch controller may be configured with a variety of operator display screens. Each set of screens provides a different level of information, some including graphical displays. All the screens identify the function of the front panel push-buttons which have the following functions.

START Causes Control 1 to be energised which will start the batch. The screen will display 'Running' until the batch is completed, or the *STOP* push-button is operated.

STOP Operating this button during a batch immediately de-energises Control 1 and Control Outputs 2 & 3 if they are used, causing the batch to pause. 'Paused' will be displayed on the screen. During a pause any input signal continues to be counted. The batch may be resumed at any time by pressing the *Start* button, or it may be aborted by operating the *Reset* button. At the end of each batch the Control Output(s) will be de-energised and 'Complete' will be displayed on the screen.

RESET After completion of a batch the batch controller must be reset before the next batch can be started. After resetting the screen displays 'Ready'. Input signals are ignored until the *Start* button is operated.

Note: Two selectable options modify the reset function.

Quick Restart eliminates the need to manually reset the BA458C at the end of each batch. When a batch is complete the batch controller will display the volume that has been dispensed. Operating the *Start* pushbutton will reset the batch controller and start another batch. See section 6.4.7

Auto Restart enables the batch controller to run continuously. At the end of each batch the controller waits for a programmable time before automatically resetting and starting another batch. This sequence will continue until a programmable number of batches has been completed or the *Stop* button is operated. See section 6.4.7

MENU

Operating this button gives access to the Operator Menu that may be protected by a four digit security code. This menu may be configured to give the operator access to any, or none of the following functions:

Select Batch	Select 1 of 9 pre-entered setpoints
Batch Size	Adjust 1 or all 9 setpoints.
Batch History	Show size of last 10 batches.
Configure	Full access to the instruments configuration menu.

If no items are contained in the menu the operator can only start, pause and stop a batch. Inclusion of the Select Batch function allows the operator to select the batch setpoint from one of nine pre-entered values. To aid identification, each setpoint may be identified by a name having up to sixteen digits.

If included in the menu, the Batch Size function allows the adjustment of all the pre-entered batch setpoints

Batch History shows the size of the last ten batches which have been completed.

The Configure function provides operator access to the batch controller configuration menus described in section 6. Entry to these menus is protected by an external security link between terminals 18 and 19 and an optional four digit security code.

2.2 Power supply failure

If the power supply for the BA458C fails during a batch, the instrument will remember the quantity of product dispensed when the supply failed, together with the number of cycle completed if autostart is being used. When power is restored, the batch controller will return in the Paused condition displaying the amount of product dispensed prior to the failure. Operating the *Start* pushbutton will complete the batch.

If the supply failure occurs when the batch controller is in the Ready or Complete state, the controller will return in the same state when power is restored.

3. INTRINSIC SAFETY CERTIFICATION

3.1 ATEX certificate

The BA458C has been issued with EC-Type Examination Certificate ITS03ATEX21379X by Notified Body Intertek Testing & Certification Ltd (ITS) which has been used to confirm compliance with the European ATEX Directive 94/9/EC for Group II, Category 1G Ex ia IIC T5 Ga equipment. The instrument bears the Community Mark and, subject to local codes of practice, may be installed in any of the European Economic Area (EEA) member countries. ATEX certificates are also acceptable for installations in Switzerland.

This section of the instruction manual describes ATEX installations in explosive gas atmospheres conforming with EN 60079-14 Electrical Installations design, selection and erection. When designing systems for installation outside the UK the local Code of Practice should be consulted.

3.2 Zones, gas groups and T rating

The BA458C has been issued with EC Type Examination certificate ITS03ATEX21379/1X confirming that it complies with the requirements for Group II Category 1 G equipment; Ex ia IIC T5 Ga (Tamb -40°C to +60°C) as specified in the ATEX Directive. When connected to a suitable system the BA458C may be installed in:

- Zone 0 explosive gas air mixture continuously present.
(Special conditions apply for installation in Zone 0 - see below)
- Zone 1 explosive gas air mixture likely to occur in normal operation.
- Zone 2 explosive gas air mixture not likely to occur, and if it does will only exist for a short time.

Be used with gases in groups:

- Group A propane
- Group B ethylene
- Group C hydrogen

Having a temperature classification of:

T1	450°C
T2	300°C
T3	200°C
T4	135°C
T5	100°C

At an ambient temperature between -40°C and $+60^{\circ}\text{C}$.

Note: the guaranteed operating temperature range of the BA458C is -20°C to $+60^{\circ}\text{C}$.

This allows the BA458C batch Controller to be installed in all Zones and to be used with most common industrial gases.

Special conditions for safe use in Zone 0

In the unlikely event of installation in a Zone 0 potentially explosive atmosphere, the BA458C batch controller shall be installed such that even in the event of rare incidents, an ignition source due to impact or friction between the aluminium enclosure at the rear of the instrument mounting panel and iron/steel is excluded.

3.3 Power supply

When installed in a hazardous area the BA458C must be powered from a Ex ia IIC certified Zener barrier or galvanic isolator having output parameters equal to or less than:

U_o	=	28.0V dc
I_o	=	96mA dc
P_o	=	0.84W

The maximum equivalent capacitance and inductance between power supply terminals 1 and 2 is:

C_i	=	0.015 μF
L_i	=	8 μH

To determine the maximum permissible cable parameters, C_i and L_i must be subtracted from the maximum cable capacitance and inductance specified by the certificate of the barrier or isolator powering the batch controller.

3.4 Inputs

The BA458C has two alternative inputs.

Input 1 (terminals 11 & 12) is for devices that require powering by the batch controller such as switch contacts, a proximity detector or a photodetector.

Input 2 (terminals 13, 14, 15, 16 & 17) complies with the requirements for *simple apparatus* and is for the connection of devices

having a voltage or current output such as a magnetic pickup or an analogue 4/20mA current.

Note: Inputs 1 and 2 can not be used simultaneously.

3.4.1 Input 1

Terminals 11 and 12 may be connected to any transducer having input parameters equal to or greater than:

U_i	=	10.6V dc
I_i	=	20mA dc
P_i	=	0.05W

The terminals may also be connected to any device such as a switch contact complying with the requirements for *simple apparatus* as specified in Clause 5.7 of EN 60079-11.

The maximum permitted capacitance and inductance for the cable plus the transducer connected to terminals 11 & 12 in a IIC hydrogen gas are:

$C_{\text{cable}} + C_i \text{ transducer}$	\leq	2.3 μF max
$L_{\text{cable}} + L_i \text{ transducer}$	\leq	90mH max

See system certificates for maximum limits for IIB and IIA gases.

3.4.2 Input 2

Terminals 13, 14, 15, 16 and 17 comply with the requirements for *Simple Apparatus* allowing any device certified Ex ia IIC with output parameters equal to or less than:

U_o	\leq	28V dc
I_o	\leq	100mA dc
P_o	\leq	0.66W

to be connected.

This allows devices with a certified voltage pulse output or a certified 4/20mA analogue current output to be connected directly to the batch controller.

The maximum equivalent capacitance C_i and inductance L_i of terminals 13 to 17 is:

C_i	=	0.018 μF
L_i	=	0.02mH

To determine the maximum permissible cable parameters, C_i and L_i must be subtracted from the maximum permissible cable capacitance and inductance specified by the certificate for the device connected to input 2.

3.5 Switch outputs

Control 1 and Outputs 1 & 2 are separate galvanically isolated solid state switches. The EC-Type Examination Certificate specifies that under fault conditions the voltage, current and power at each switch output will not exceed those specified for *simple apparatus* in Clause 5.7 of EN 60079-11. This allows each of the BA458C switch outputs to be connected to any intrinsically safe circuit protected by a certified Zener barrier or galvanic isolator providing that the output parameters of each circuit are less than:

$$\begin{aligned} U_o &\leq 28V \text{ dc} \\ I_o &\leq 200\text{mA} \\ P_o &\leq 0.85W \end{aligned}$$

The maximum equivalent capacitance and inductance of each BA458C switch output are:

$$\begin{aligned} C_i &= 0.04\mu\text{F} \\ L_i &= 0.02\text{mH} \end{aligned}$$

To determine the maximum permissible cable parameters, C_i and L_i must be subtracted from the maximum cable capacitance and inductance specified by the certificate of the barrier or isolator connected to the switch.

3.6 External switches

For applications requiring the batch controller to be operated via large industrial push-buttons, terminals S1 to S7 may be connected to six external switches.

Terminals S1 to S7 have the following combined output safety parameters:

$$\begin{aligned} U_o &= 14.7V \text{ dc} \\ I_o &= 99\text{mA} \text{ dc} \\ P_o &= 0.6W \end{aligned}$$

The switches and associated wiring connected to the terminals must comply with the requirements for *simple apparatus*. i.e. they must have IP20 protection and be capable of withstanding a 500V rms insulation test to earth for one minute. Most industrial push-buttons satisfy these requirements

The total maximum permitted cable parameters for all the cables connected to terminals S1 to S7 in a IIC hydrogen gas are:

$$\begin{aligned} C_o &\leq 0.15 \mu\text{F} \\ L_o &\leq 0.48\text{mH} \end{aligned}$$

These are not restrictive and allow a significant distance between the switches and the instrument.

3.7 Inhibit and Security Links

The inhibit and security links have the following combined output safety parameters:

$$\begin{aligned} U_o &= 11.7V \text{ dc} \\ I_o &= 2.4\text{mA} \text{ dc} \\ P_o &= 7\text{mW} \end{aligned}$$

A wire link may be connected between the terminals, or if frequent changes are required switches may be used. These switches and associated wiring must comply with the requirements for *simple apparatus*. i.e. they must be mechanically activated, have IP20 protection and be capable of withstanding a 500V rms insulation test to earth for one minute.

The total maximum permitted cable parameters for all the cables connected to terminals 18, 19 & 20 in a IIC hydrogen gas are:

$$\begin{aligned} C_o &\leq 1.5\mu\text{F} \\ L_o &\leq 1\text{H} \end{aligned}$$

These are not restrictive and do not limit the separation between the batch controller and the switches.

3.8 Certification Label Information

The certification label is fitted in a recess on the top outer surface of the enclosure. It shows the ATEX certification information plus BEKA associates name, location, instrument serial number and year of manufacture. Non European certification information may also be included.



4. SYSTEM DESIGN FOR HAZARDOUS AREAS

4.1 System Certificates

In addition to the EC-Type Examination Certificate, ITS have issued two System Certificates for the BA458C batch controller. One defines how the BA458 may be used with Zener barriers and the other with galvanic isolators. Both are divided into two sections to cover input signal sources in the hazardous and the safe area.

Interface	Certificate No.
Zener barriers	Ex03E21380
Galvanic isolators	Ex03E21381

System Certificates are Certificates of Conformity which are primarily issued for installation guidance in the UK. They do not form part of the certification to the ATEX Directive.

4.2 Use with Zener barriers

Zener barriers are the least expensive intrinsically safe interface between a safe and hazardous area. However they do not provide isolation and require a high integrity earth connection that may be expensive to install. For a single BA458C batch controller installation it may be less expensive and complicated to use galvanic isolators when a high integrity earth connection is not already available.

Any Zener barrier certified Ex ia IIC by a Notified Body may be used, providing that the safety parameters are within the limits specified by the BA458C EC-Type Examination Certificate. Only one polarity of Zener barrier, i.e. positive or negative, may be used with each BA458C batch controller installation.

To assist with system design, the Zener barrier System Certificate specifies the safety description of barriers that may be used and lists the maximum permitted cable parameters.

Fig 3 illustrates the basic circuit that is used for all BA458C installations protected by Zener barriers. Although the BA458C batch controller will operate from a wide range of input sources, only one source may be connected at any time.

Alternatively the input source may be located in the safe area. Fig 4 shows how an additional Zener barrier may be used to transfer the signal from the safe area to the batch controller in the hazardous area. For switch contact and open collector inputs the

additional end-to-end resistance of the Zener barrier must not prevent the input at the batch controller terminals passing through the batch controllers input switching thresholds.

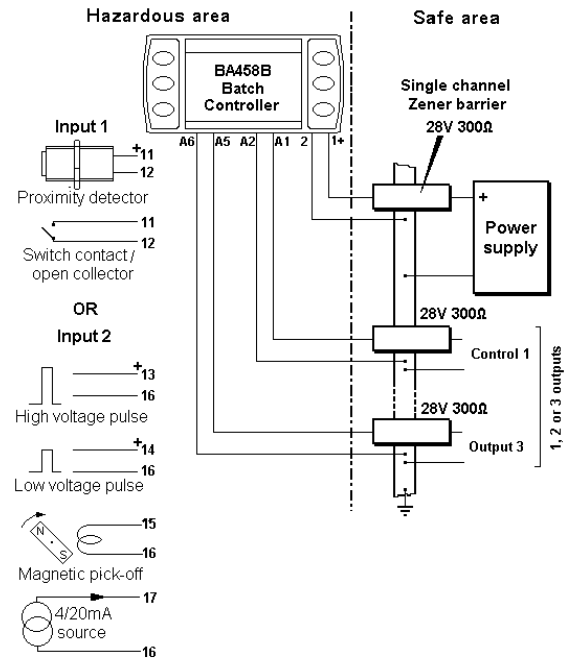

Fig 3 Batch controller powered via a Zener barrier with input in hazardous area.

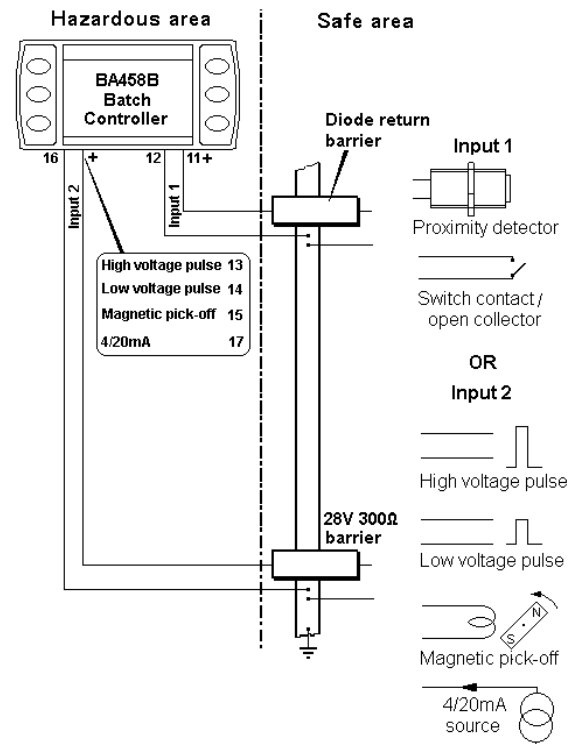

Fig 4 Batch controller protected by galvanic isolators with Input in safe area

4.2.1 Power supply

Usually a BA458C batch controller is powered from the safe area via a positive polarity 28V 300Ω Zener barrier which has an end-to-end resistance of about 340Ω. The BA458C consumes a maximum current of 33mA and requires a minimum voltage of 11V between terminals 1 and 2. When powered from a 28V 300Ω Zener barrier, the supply voltage in the safe area must be between 22.2V and the maximum working voltage of the barrier which is usually about 26V.

CAUTION

The safety components within the batch controller limit the voltage between terminals 1 and 2 at 15V. If the batch controller is directly connected to a 15V or greater power supply without a Zener barrier or equivalent series resistor, the instrument will consume a large current for a few seconds and then shut-down to prevent permanent damage. To test a BA458C batch controller in a safe area workshop, terminals 1 & 2 should be connected to a 24V dc power supply via a 330Ω resistor.

4.2.2 Pulse inputs

As shown in Figs 3 and 4 the BA458C batch controller may be connected to a wide variety of pulse transducers and sources in the hazardous or safe area. Input 1 is for pulse sources that need powering by the batch controller such as switch contacts or a 2-wire proximity detector. Input 2 is for voltage pulse inputs such as the magnetic pickup in a turbine flowmeter, or a voltage pulse output from a flowmeter.

The following table shows the switching thresholds for the various transducers, plus the maximum operating frequency and the input terminal numbers. For reliable counting the input signal must fall below the lower switching threshold and rise above the upper threshold.

	Switching thresholds		Freq max	Input terminals
	100Ω	1000Ω		
Switch	100Ω	1000Ω	100Hz	12 & 11 +
Proximity detector	1.2mA	2.1mA	5 kHz	12 & 11 +
Open collector	2kΩ	10kΩ	5kHz	12 & 11 +
Magnetic pickup	10mV	30mV	5kHz	16 & 15 +
Low voltage pulse	1V	3V	5kHz	16 & 14 +
High voltage pulse	3V	10V	5kHz	16 & 13 +

Note: Only one input may be used at a time.

4.2.2.1 Switch contact input

Any mechanically activated switch contact located in the hazardous area may be connected directly to terminals 12 & 11 providing the switch has IP20 protection and can withstand a 500V rms insulation test to earth. Most magnetically activated reed relays used in turbine flowmeters comply with this requirement.

The maximum operating frequency for a switch contact input is 100Hz.

4.2.2.2 2-wire proximity detector input

Any Ex ia certified intrinsically safe 2-wire proximity detector complying with NAMUR switching thresholds may be used, providing the input safety parameters of the proximity detector are equal to or greater than:

$$\begin{aligned} U_i &\geq 10.6V \text{ dc} \\ I_i &\geq 20mA \text{ dc} \\ P_i &\geq 50mW \end{aligned}$$

If located in the same hazardous area as the batch controller the proximity detector may be directly connected to terminals 12 & 11

When programmed to operate with a proximity detector, the maximum input frequency of the BA458C batch controller is 5kHz.

4.2.2.3 Voltage pulse input

Voltage pulse sources may be connected directly to input 2, the terminals used depend upon the input magnitude – see the table in section 4.2.2. All these terminals comply with the requirements for *simple apparatus* and they may be directly connected to any Ex ia certified intrinsically safe voltage source within the hazardous area. The source must be able to withstand a 500V rms insulation test to earth for one minute and have output parameters equal to or less than:

$$\begin{aligned} U_o &\leq 28V \text{ dc} \\ I_o &\leq 100mA \text{ dc} \\ P_o &\leq 0.66W \end{aligned}$$

This enables the BA458C to be connected directly to most flowmeters incorporating a certified intrinsically safe magnetic pickup, or a certified intrinsically safe amplifier producing a high level pulse output. The BA458C has three selectable voltage switching thresholds, for magnetic pickups, low voltage pulses and high voltage pulses.

When programmed to operate with a voltage pulse source, the maximum input frequency of the BA458C batch controller is 5kHz.

4.2.3 4/20mA analogue input

The BA458C can also accept an analogue 4/20mA input representing rate of flow from a current source, **not a current sink**. Loop powered flow transmitters require an additional power supply. The analogue input terminals comply with the requirements for *simple apparatus* allowing almost any intrinsically safe 4/20mA signal to be connected directly to the batch controller.

	Voltage drop	Freq. Max.	Input terminals
4/20mA	0.6V	2Hz	16 & 17+

4.2.4 Switch outputs

Each of the three switch outputs is a galvanically isolated single pole solid state switch as shown in Fig 5.

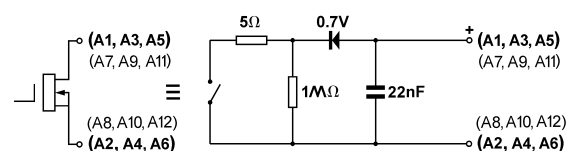

Fig 5 Equivalent circuit of each switch output

The output is polarised so current will only flow in one direction. Terminals A1, A3 and A5 should be connected to the positive side of the supply. The 'on' and 'off' performance of each switch output is:

$$\begin{aligned} R_{on} &= 5\Omega + 0.7V \\ R_{off} &= \text{greater than } 1M\Omega \end{aligned}$$

Any hazardous area intrinsically safe circuit may be switched by one of these outputs providing the output safety parameters of the circuit are less than the maximum input parameters of the switch. Alternatively the switch contact may be transferred to the safe area via a Zener barrier which again must have safety parameter less than the maximum input safety parameters of the switch.

Notes: Because of the series protection diode, some test meters may not detect a closed switch output.

Terminals A7 to A12 are for optional factory fitted outputs 4, 5 and 6.

WARNING

These switch outputs should not be used for critical safety applications.

When the BA458C power supply is turned off or disconnected, all BA458C switch outputs will open.

4.3 Use with galvanic isolators

Galvanic isolators are probably the simplest intrinsically safe interface as they provide isolation and do not require a high integrity earth connection.

Any galvanic isolator certified Ex ia IIC by a Notified Body may be used providing that the safety parameters of the isolator terminals are compatible with the safety parameters of the batch controller terminals to which the isolator is connected.

To assist with system design, the galvanic isolator System Certificate specifies the safety description of the galvanic isolators that may be used and lists the maximum permitted cable parameters.

Fig 6 illustrates the basic circuit that is used for all BA458C installations protected by galvanic isolators. Although the BA458C batch controller will operate from a wide range of input sources, only one source may be connected at any time.

Alternatively the input source may be located in the safe area. Fig 7 shows how an additional isolator may be used to transfer the input signal from the safe area to the batch controller in the hazardous area.

4.3.1 Power supply

Any certified galvanic isolator may be used to power the BA458C providing the output safety parameters are less than the maximum permitted input safety parameters of terminals 1 & 2. In addition to matching the safety parameters, the isolator must be capable of supplying at least 11V to terminals 1 & 2 at 33mA.

CAUTION

The safety components within the batch controller limit the voltage between terminals 1 and 2 at 15V. If the batch controller is directly connected to a 15V or greater power supply without a galvanic isolator or equivalent series resistor, the instrument will consume a large current for a few seconds and then shut-down to prevent permanent damage. To test a BA458C batch controller in a safe area workshop, terminals 1 & 2 should be connected to a 24V dc power supply via a 330Ω resistor.

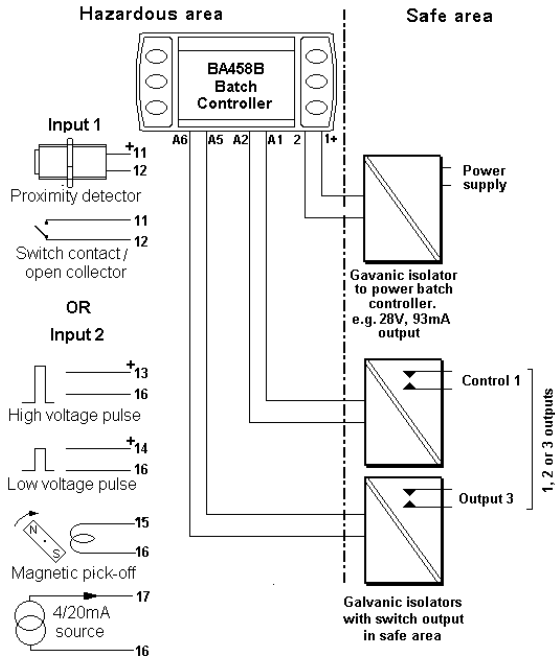

Fig 6 Batch controller powered by a galvanic isolators with input in hazardous area.

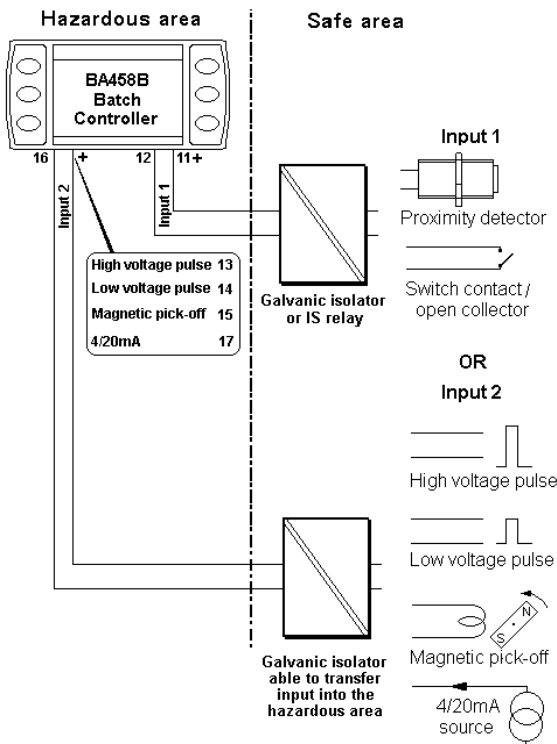

Fig 7 Batch controller protected by galvanic isolators with input in the safe area.

4.3.2 Inputs

When the batch controller is powered from a galvanic isolator, the pulse and analogue inputs remain the same as described in sections 4.2.2 and 4.2.3. Only when the input transducer or source is in the safe area, as shown in Fig 7, are galvanic isolators required in the input circuit.

Any Ex ia IIC certified galvanic isolator may be used providing that the safety parameters of the isolator terminals are compatible with the safety parameters of the batch controller input terminals to which it is connected. The galvanic isolator must also be able to transfer the required type of input into the hazardous area.

4.3.3 Switch outputs

WARNING

These switch outputs should not be used for critical safety applications.

When the batch controller is powered from a galvanic isolator, the switch outputs remain the same as described in section 4.2.4. Only when the switch output is required in the safe area is a galvanic isolator required. A wide variety of switch transfer isolators are available with a selection of relay and solid state outputs. Again the output parameters of the galvanic isolator must be less than the maximum permitted input parameters of the batch controller switch.

4.4 External switches

For applications requiring the batch controller to be operated via large industrial push-buttons, four external switches may be connected as shown in Fig 2. Unlike the front panel pushbuttons, each external switch has a dedicated operating and configuration function.

Switch number	Switch function when	
	Operating	Configuring
S1	Start	Down
S2	Stop	Up
S3	Reset	P
S4	Menu	E

Section 3.6 describes the use of external switches in the hazardous area, but they may also be located in the safe area.

A certified intrinsically safe relay or a galvanic isolator with a switch contact output is required to transfer the switch contact from the safe to the hazardous area. The combined permitted input safety parameters for batch controller terminals S1 to S7 are zero, therefore Zener barriers can not be used.

Fig 8 shows how the external *Stop* buttons may be located in the safe and hazardous areas.

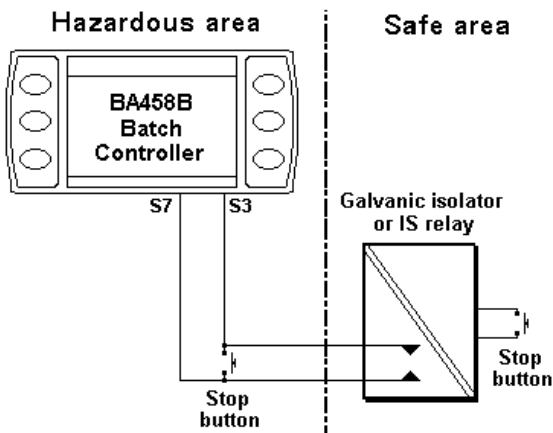

Fig 8 Stop buttons in hazardous & safe areas

4.5 Inhibit link

Linking terminals 18 and 20 together inhibits the batch controller input. If linked during a batch, dispensing will continue but it will not be shown on the batch display. These terminals may only be connected to a hazardous area mechanically operated switch having IP20 protection and able to withstand an ac test voltage of 500V to earth for one minute. See section 3.7.

4.6 Security link

Access to the configuration menus is only available when terminals 18 & 19 are linked together – see section 6.1. These terminals may only be linked together at the instrument, or connected to a hazardous area mechanically operated switch having IP20 protection and able to withstand an ac test voltage of 500V to earth for one minute. See section 3.7.

5. INSTALLATION

5.1 Location

The BA458C is housed in a robust aluminium enclosure with a toughened glass window mounted in a Noryl bezel. The front of the instrument provides IP65 protection and a gasket seals the joint between the instrument enclosure and the panel. The instrument may be installed in any panel providing the environmental limits shown in the specification are not exceeded.

Fig 9 shows the overall dimensions of the BA458C and the panel cut-out. To achieve an IP65 seal between the instrument enclosure and the panel, the smaller cut-out must be used and the instrument secured with four panel mounting clips.

The BA458C liquid crystal display has maximum contrast when viewed from directly ahead and slightly below the centre line of the instrument.

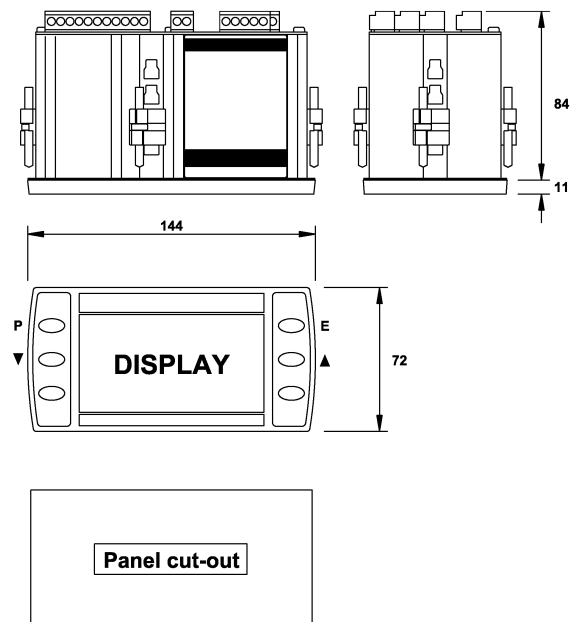

Cut-out Dimensions

DIN 43 700

138.0 +1.0/-0.0 x 68.0 +0.7/-0.0

**To achieve an IP65 seal
between instrument enclosure
and panel**

136.0 +0.5/-0.0 x 66.2 +0.5/0.0

Fig 9 BA458C dimensions

5.2 Installation Procedure

- a. Insert the BA458C into the instrument panel cut-out from the front of the panel.
- b. Fix panel mounting clips to opposite sides of the instrument and tighten. Recommended tightening torque is 22cNm (1.95lbf in). **Do not over tighten.** Four clips are required to achieve an IP66 seal between the instrument enclosure and the panel.
- c. Connect the panel wiring to the rear terminal block(s) as shown in Fig 10. To simplify installation, the terminals are removable so that panel wiring can be completed before the instrument is installed.

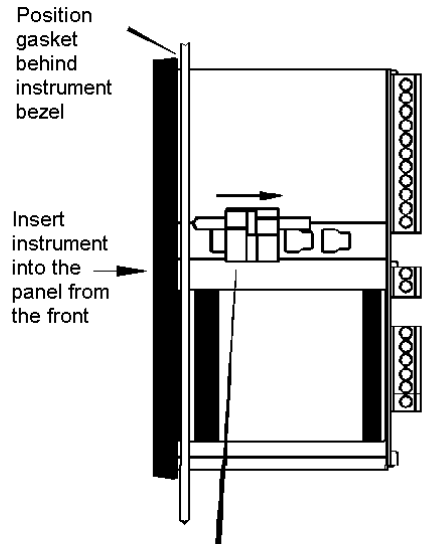

Slide panel mounting clip into the slotted rail on the side of the enclosure. Four clips are required to achieve an IP65 seal between the instrument and the panel

5.3 EMC

The BA458C complies with the requirements of the European EMC Directive 89/336/EEC. For specified immunity all wiring should be in screened twisted pairs.

To prevent circulating currents, cable screens should only be earthed at one point in the safe area.

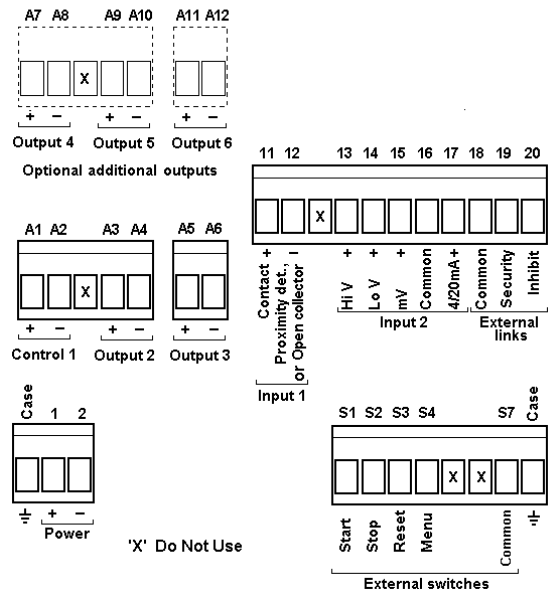

Fig 10 Installation and terminal connections

6. CONFIGURATION MENUS

The BA458C batch controller is configured via the front panel pushbuttons. Configuration functions are contained in three easy to use sub-menus, 'System Settings', 'Batch Settings' and 'Rate Settings'. A fourth sub-menu 'Information' shows how the instrument has been configured.

Although the BA458 batch controller contains many sophisticated functions, it remains simple to operate and configure. Menu navigation is explained in section 6.2. Guided by on-screen prompts, the use of the configuration functions is intuitive, but all the functions are fully described in this manual.

6.1 Security

To prevent unauthorised or accidental adjustment, the configuration menus can only be accessed when an external link is fitted between terminals 18 and 19 as shown below.

Terminals 18 and 19	Access to configuration menus
Linked	Yes
Not linked	No

When authorised personnel need to make frequent configuration adjustments, the security link terminals may be wired to a key switch located in the hazardous area.

The configuration menus may also be protected by a user selectable four digit security code.

A separate four digit user selectable security code may be applied to the operator menu

6.2 Navigation

The BA458C is configured via the front panel push-buttons which are soft-keys identified on the display screen.

This manual contains simplified drawings of the batch controller display screens associated with most functions. Although some screens may consist of multiple pages that are automatically accessed by scrolling through the options, in this manual they are shown on one page with the default option in bold.

Within this manual push-buttons are shown in italics e.g. *P* or *Up* push-button and legends displayed by the batch controller are shown within inverted commas e.g. 'Running'.

When the batch controller is displaying 'Ready' access to the main configuration menu is

obtained by pressing the *P* and *E* buttons simultaneously or, if enabled, via the Operator Menu. The configuration menu can not be accessed while the batch controller is running.

Once within the main menu the *Up* and *Down* buttons move the highlight bar between sub-menus. When the required option has been highlighted, operating the *P* button will access the sub-menu.

The highlight bar is static when indicating a menu or sub-menu. When indicating an option which has to be selected, or a variable that has to be entered, the highlight bar flashes on and off.

The configuration main menu comprises four sub-menus:

System Settings	Defines function of batch controller including outputs & display screen. See Fig 11 & section 6.4
Batch Settings	Defines batch parameters. See Fig 14 & section 6.5
Rate Settings	Defines rate parameters. See Fig 16 & section 6.6
Information	Lists all the batch controller settings and allows the Grand Total to be read. See Appendix 2

Highlighting the required function within the sub-menu and operating the *P* pushbutton will enter the function menu. Functions offer a choice of options or an invitation to enter a variable.

To select an option in a function menu

Press the *Up* or *Down* button to move the flashing display highlight bar to the required option, operating the *E* button will then store the selected option and move the display up one level to the sub-menu.

To enter a variable

Variables are entered digit by digit, the flashing digit being adjusted using the *Up* or *Down* button. When a digit is set as required operating the *P* button will transfer control to the next digit. When all the digits have been adjusted, operating the *E* button will store the variable and move the display up one level to the sub-menu.

When navigating through the menus the push-button(s) should be held until the required screen is displayed.

Note:

Functions that are dependent on a higher level option are automatically removed from the sub-menu when the higher level option is not selected. e.g. If the batch controller is configured for a pulse input, all the calibration functions associated with a 4/20mA input will be automatically removed from the menus.

Rate Settings

Rate Scaling	000001.
Rate D.P.	00000.0
20mA Display	00100.0
Rate Legend	No legend
Timebase	Seconds
Rate Filter	
Smoothing	2
Jump-Out	4
Flow Alarm	00000.0
Inhibit Time	0000
Clip-Off	00000.0

6.3 Default configuration

Unless otherwise requested at the time of ordering, BA458C batch controllers will be supplied configured as follows:

Default parameters may be globally restored see section 6.4.13

System Settings

Language	English
Operator control	Both Local & Remote.
Signal Input	Open Collector
Lineariser	Off
Restart	Normal
Output 2	Unused
Output 3	Unused
Optional outputs 4, 5 & 6	Unused
Pulse Output	Display / 1
Grand Total	Cleared
Security	
Config. Code	0000
Operator Code	0000
Operator Menu	
Batch Sizing	On
Batch Select	On
History	On
Config. Menu	On
Operator Screens	Screen 1

Batch Settings

Scale factor (Linear pulse)	000001.
Scaling (4/20mA input)	000001.
Batch D.P.	00000000.
Batch Legend	No legend
Batch Limit	99999999
Batch Names	Batch 1
Batch Size	00000000.
Select Batch	Batch 1
CONTROL2delay	0000
CONTROL2stop	00000000.
CONTROL3delay	0000
CONTROL3stop	00000000.
Count Mode	Up
Overrun Comp	Off
Batch Cycles	1
Restart Delay	00 : 00 : 00

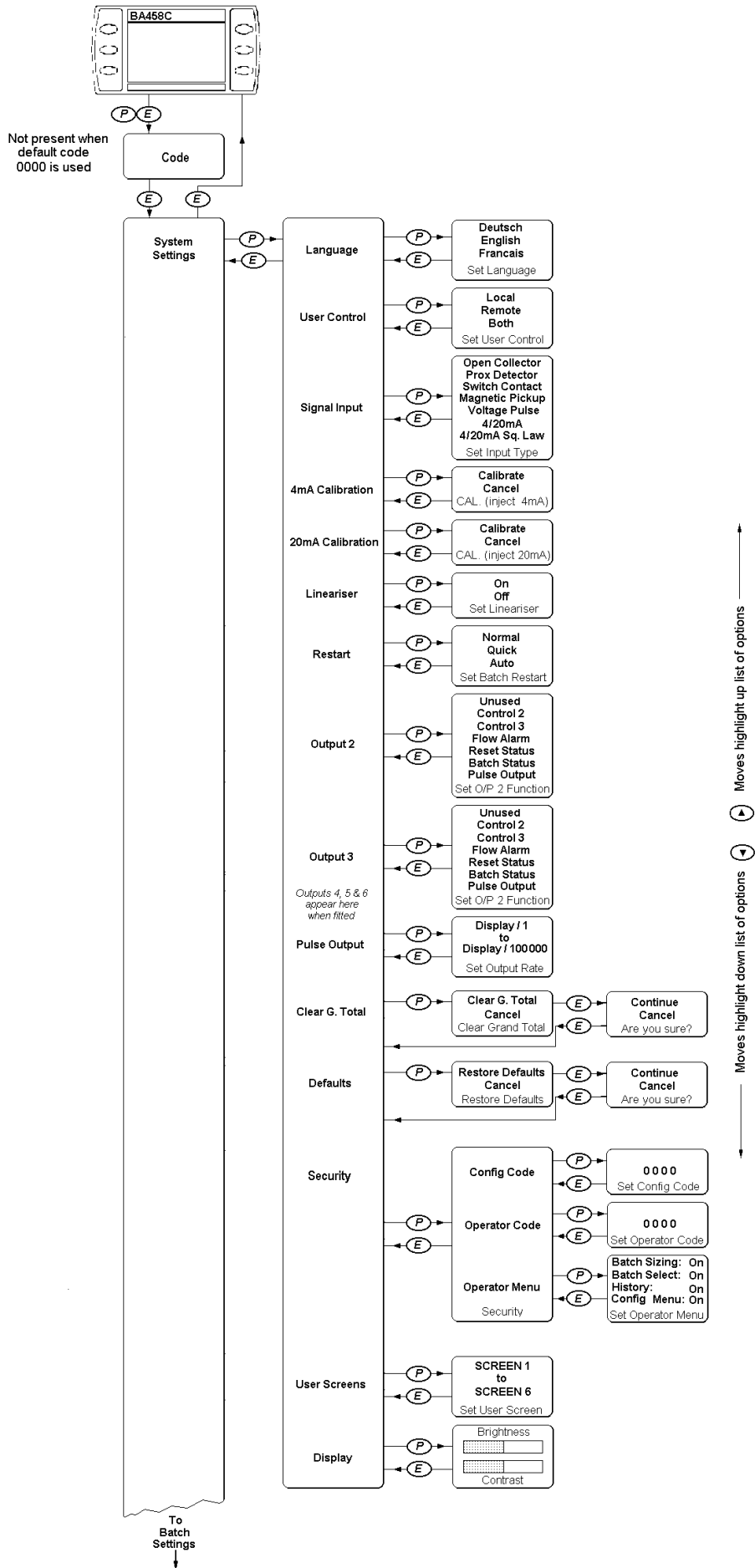

Fig 11 System Settings

6.4 SYSTEM SETTINGS

See Fig 11.

6.4.1 Language

The BA458C can display operating messages and menus in three different languages:



Highlight the required language and press *E* to enter the selection.

6.4.2 User Control

The BA458C batch controller may be controlled by the front panel pushbuttons, by remote switches or by both the front panel switches and the remote switches.



Highlight the required option and press *E* to enter the selection.

6.4.3 Signal Input

A wide variety of analogue and digital transducers and sources may be connected to the batch controller.

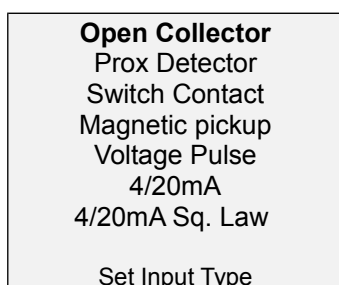

Notes: Input terminals vary depending upon the type of input, see sections 4.2.2 and 4.2.3.

The brilliance of the display backlight is reduced when open collector, proximity detector or switch contact inputs are selected.

6.4.4 4mA Calibration

Note: Only necessary when 4/20mA input is used

When the BA458C batch controller is supplied the analogue current input will have been accurately factory calibrated, it is only necessary to perform this calibration as part of routine maintenance.

To perform the calibration connect a 4 to 20mA current source to batch controller terminals 16 & 17(+) and adjust the input current to exactly 4mA. To achieve maximum batch controller performance, the accuracy of the current source should be greater than $\pm 0.025\%$ (4uA).

To prevent the batch controller calibration being accidentally corrupted the instruction has to be confirmed before it will be executed.

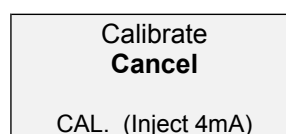

Highlight the 'Calibrate' option and operate the *E* pushbutton, which will result in the confirmation screen being displayed. To perform the calibration highlight 'Continue' and press *E*, after a few seconds the display will return to the System setting menu.

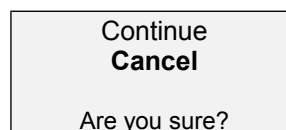

6.4.5 20mA Calibration

This function is identical to the 4mA calibration described in the previous section 6.4.4, but a 20mA input current should be used.

6.4.6 Lineariser (Pulse inputs)

The 16 point straight line lineariser will compensate for k-factor non-linearity in turbine flowmeters.

This function turns the lineariser on and off, calibration parameters are entered in the Batch Setting menu – See sections 6.5.1 and 6.5.2 .



Highlight the required setting and press *E* to enter the selection.

6.4.7 Restart

This function determines what happens at the end of each batch. There are three options:

Normal: The display screen shows the volume that has been dispensed. Before another batch can be started the *Reset* push-button must be operated. The screen will then display 'Ready'.

Quick: The display screen shows the volume that has been dispensed. Operating the *Start* pushbutton will reset the batch controller and start another batch.

Auto restart: The display screen shows the volume that has been dispensed. After a configurable restart delay (See 6.5.19) the batch controller automatically resets and starts another batch. The number of batch cycles to be performed is defined by the Batch Cycle function, which is contained in the Batch Setting menu. See 6.5.18

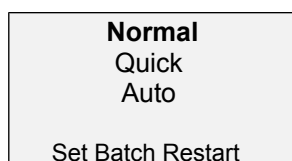

Highlight the required option and press *E* to enter the selection.

6.4.8 Output 2

Output 2 is an isolated single pole solid state switch contact that is connected to terminals A3 and A4. It may be configured to output any one of six different signals, or may be unused.

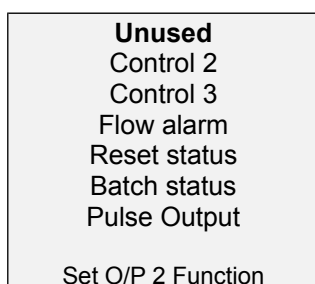

Highlight the required option and press *E* to enter the selection.

Note: Two or more of the outputs may be configured to output the same function.

6.4.9 Output 3

As Output 2 except terminals are A5 and A6.

6.4.10 Optional outputs 4, 5 and 6

Only available when factory fitted option is installed in the BA458C batch controller. Configuration is the same as for Output 2, except terminal numbers are:

Output	Terminal numbers
4	A7 & A8
5	A9 & A10
6	A11 & A12

6.4.11 Pulse Output

Any of the batch controller outputs may be configured as a pulse output. The number of output pulses is proportional to the total volume dispensed by the batch controller. This Pulse Output function enables the pulse output frequency to be reduced by one of five dividing factors between 10 and 100,000.

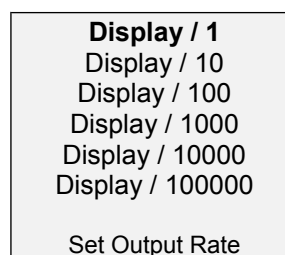

Highlight the required option and press *E* to enter the selection.

Note: Maximum output frequency is 4 Hz.

6.4.12 Clear Grand Total

The Grand Total is a record of the total quantity of product dispensed since the Grand Total was last reset to zero. It must be zeroed every time the batch controller scaling is changed. The Grand Total can be viewed in the Information section of the System Menu – see section 6.2.

CAUTION

**After zeroing the old grand total
can not be recovered**

To prevent the Grand Total being accidentally zeroed, the clear instruction has to be confirmed before it will be executed.

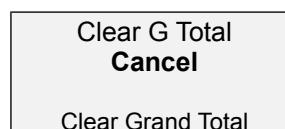

If 'Clear G Total' is highlighted and the *E* pushbutton operated, a second screen will be presented. To confirm that the Grand Total is to be zeroed highlight 'Continue' and press *E* which will result in the instruction being executed.

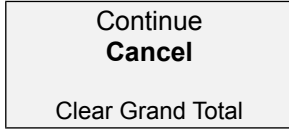

6.4.13 Defaults

This function allows the configuration defaults listed in section 6.3 to be globally restored. Although useful for defining a starting point when commissioning a batch controller, the settings overwritten by this command can not be recovered

CAUTION

After restoring default configuration the previous settings can not be recovered.

To prevent the default settings being accidentally restored, the instruction has to be confirmed before it will be executed.

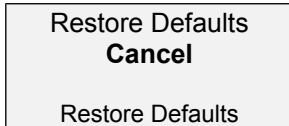

If 'Restore Defaults' is highlighted and the *E* pushbutton operated, a second screen will be presented. To confirm that the defaults are to be restored, highlight 'Continue' and press *E* which will result in the instruction being executed.

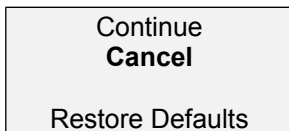

6.4.14 Security

A summary of instrument security is contained in section 6.1 of this manual.

This security function enables the four digit security codes protecting the configuration and operator menus to be defined. It also allows the contents of the operator menu to be selected.



Highlighting the required function and pressing *P* will result in a selection menu being displayed.

Each of the two security codes is entered digit by digit, when all four digits have been set, pressing *E* will enter the code and return the display the security menu.



Note: Default code 0000 disables the security function and allows unrestricted access to the menu.

Access to the Configuration Menus is also protected by an external link as described in section 6.1

Contents of the Operator Menu are defined by toggling the 'On / Off' box associated with each item. To make the selection, highlight the item to be changed and operate the *P* button. The item may then be turned 'On' or 'Off' using the *Up* or *Down* push-buttons.

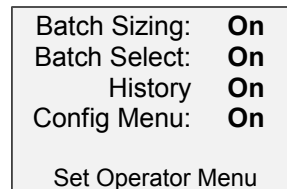

Pressing *E* will enter the selection, another item may then be selected or the display returned to the Security menu by pressing *E* again.

6.4.15 Operator Screens

The user screen may be selected from six different formats that are shown in Appendix 1.

They show different information and have different display sizes so that the operator is only presented with the essential information necessary to operate the batching system. Some screens include graphical information allowing batch progress to be rapidly assessed. Screen formats are shown in Appendix 1.

Screen 6 is intended for commissioning and shows all engineering information including output status and flow rate.

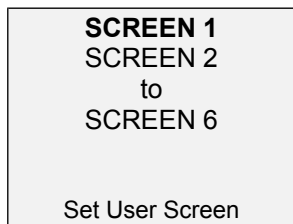

Highlight the required option and press *E* to enter the selection.

6.4.16 Display

The display contrast and backlight brilliance are adjustable using this function. The two adjustments are made with the *Up* and *Down* buttons, the amplitude of each being shown on a horizontal bargraph. Control is transferred between brilliance and contrast by operating the *P* pushbutton.

After adjustment pressing *E* enters the changes and returns the display to the System Menu.

6.4.17 Output options

Control 1 is a dedicated output that is always connected to terminals A1 and A2. Control 1 is energised immediately the *Start* button is operated and de-energised when the batched volume equals the batch setpoint.

Outputs 2 and 3 may be configured to output six different signals or they may be unused as described in sections 6.4.8 & 9. The following sections describe each of these selectable signals.

6.4.17.1 Control 2

This output is similar to Control 1. It is energised a configurable time CONTROL2delay after Control 1 is energised and de-energised a configurable batched

volume CONTROL2stop before Control 1 is de-energised. Fig. 1 shows the operation diagrammatically.

6.4.17.2 Control 3

This output is identical to Control 2 except delays are defined by CONTROL3delay and CONTROL3stop.

6.4.17.3 Flow alarm

This output is described in section 6.6.7

6.4.17.4 Reset status

The reset status output indicates when the batch has been started and when the controller has been reset and is ready to start another batch. See Fig 12.

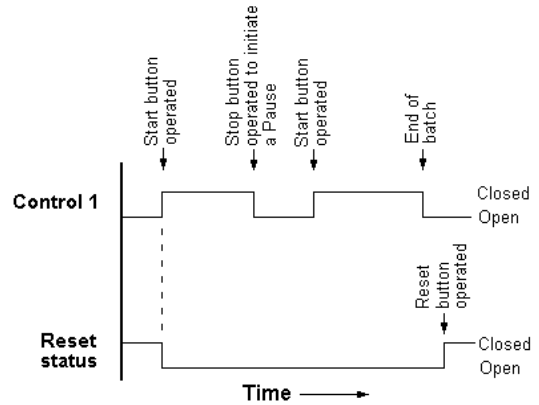
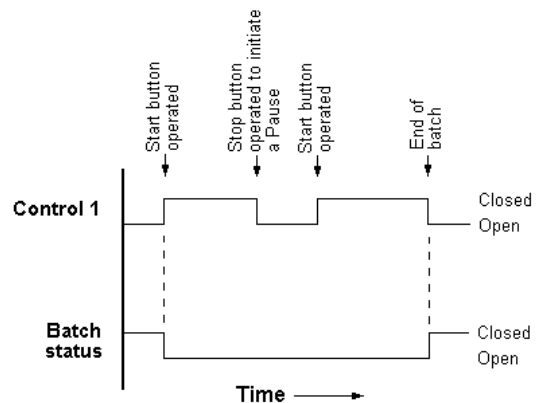

Fig 12 Reset status timing

6.4.17.5 Batch status

The batch status output is the inverse of Control 1 except that it does not close if a pause is initiated during a batch. See Fig 13.



Batch status is inverse of Control 1 but does not close when batch controller is Paused

Fig 13 Batch status timing

6.4.17.6 Pulse output

This output is described in section 6.4.11

BLANK PAGE

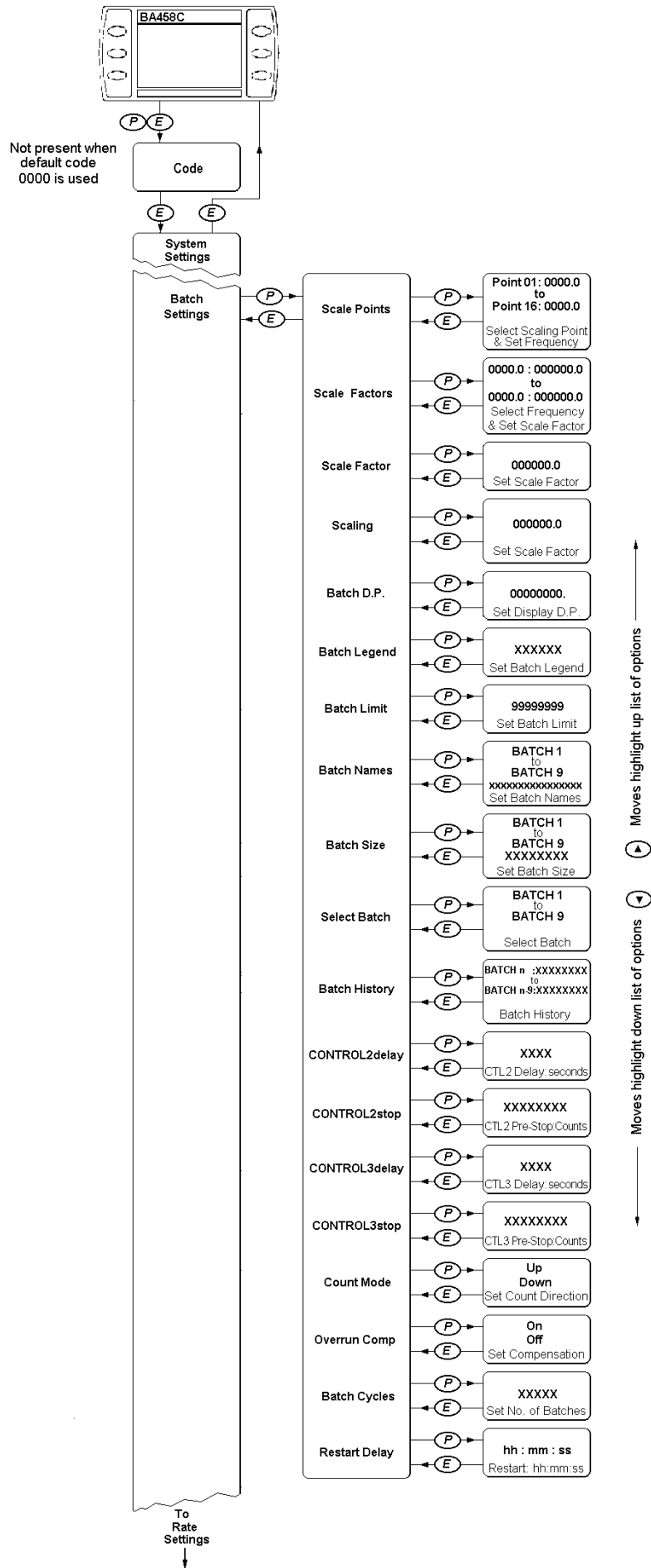

Fig 14 Batch Settings

6.5 BATCH SETTINGS

See Fig 14.

6.5.1 Scale Points (Non-linear pulse inputs)

This and the following Scale Factors function described in section 6.5.2 are used to calibrate the 16 point lineariser. The lineariser is activated from the System Menu - see section 6.4.6.

Fig 15 shows the relationship between input frequency and Scale Factor for a lineariser using three breakpoints. Up to sixteen breakpoints may be used, the input frequency for any breakpoints that are not required should be set to zero.

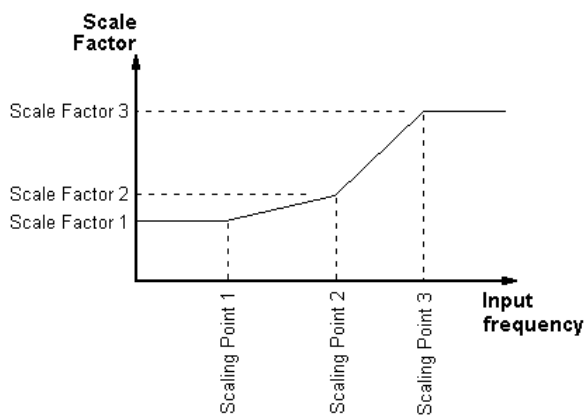

Fig 15 Three point lineariser

The Scale Factor at input frequencies below the lowest Scaling Point is the same as that entered for the lowest Scaling Point.

The Scale Factor for input frequencies above the highest Scaling Point is the same as that entered for the highest Scaling point.

The Scale Factor at input frequencies between two Scaling Points is calculated according to a straight line between the Scale Factors at the two points.

The input frequency at which each breakpoint is require should be set using this function.

Point 01: XXXX.X
to
Point 16: XXXX.X

Select Scaling Point / Set Frequency

6.5.2 Scale Factors (Non-linear pulse inputs)

The k factor of a flowmeter is the number of output pulses that it produces per unit volume e.g. 70 pulses per litre.

The batch controller's Scale Factor is a dividing factor adjustable between 0.001 and 999999, which is used to convert the output pulses from the flowmeter into a volume display in engineering units.

$$\text{Volume displayed} = \frac{\text{Number of input pulses}}{\text{Scale Factor}}$$

If the Scale Factor is set to the flowmeter's k factor, the batch controller will display volume in the flowmeter's engineering units.

e.g. For a flowmeter having a k factor of 70 pulses per litre, the batch controller Scale Factor may be selected to provide the required display

Scale Factor	Least significant Display digit represents Litres
0.7	Hundredths of a Litre
7.0	Tenths of a Litre
70.0	Litres
700.0	Tens of Litres
7000.0	Hundreds of Litres
318.2	Gallons

(There are 4.54609 litres in a UK gallon)

This function sets the required Scale Factor at each Scaling Point input frequency (breakpoint) defined in the Scaling Point function described in section 6.5.1

XXXX.X: XXXXXX
to
XXXX.X: XXXXXX

Select Frequency / Set Scale Factor

6.5.3 Scale Factor (For linear pulse inputs)

The k factor of a flowmeter is the number of output pulses that it produces per unit volume e.g. 70 pulses per litre.

The batch controller's Scale Factor is a dividing factor adjustable between 0.001 and 999999, which is used to convert the output pulses from the flowmeter into a volume display in engineering units.

$$\text{Volume displayed} = \frac{\text{Number of input pulses}}{\text{Scale Factor}}$$

If the Scale Factor is set to the flowmeter's k factor, the batch controller will display volume in the flowmeter's engineering units.

e.g. For a flowmeter having a k factor of 70, the Cal Value may be selected to provide the required display

Scale Factor	Least significant Display digit represents Litres
0.7	Hundredths of a Litre
7.0	Tenths of a Litre
70.0	Litres
700.0	Hundreds of Litres
318.2	Gallons

(There are 4.54609 litres in a UK gallon)

000001.
Set Scale Factor

6.5.4 Scaling (For 4/20mA input)

The 4/20mA analogue output from a flowmeter represents the rate of flow, which may be displayed by the BA458C batch controller in any engineering units. See section 6.6.3

Total batched volume is calculated by integrating the flow rate during the batching period.

The batch controller Scale Factor, which is a dividing factor that may be adjusted between 0.001 and 999999, defines the arithmetic relationship between the units of measurement of the rate and the total batched displays.

$$\text{Scale Factor} = \frac{\text{Units of batched display}}{\text{Units of rate display}}$$

When calculating this Scale Factor, the required units of measurement for the total batched display must be converted to those used for the rate display as shown in the following example.

The BA458C rate display represents litres per second but the total batched display is required in UK gallons.

$$\text{Scale Factor} = \frac{\text{Units of batched display}}{\text{Units of rate display}}$$

$$= \frac{1 \text{ gallon}}{1 \text{ litre}} = \frac{4.5461 \text{ litre}}{1 \text{ litres}}$$

$$\text{Scale Factor} = 4.5461$$

If the rate display and the total batched display are required in the same units of measurement, the Scale Factor should be set to 1.0

000001.
Set Scale Factor

6.5.5 Batch D.P.

The position of the decimal point in the batch display, which determines the resolution of the display, is set by this function. In operation leading zeros are suppressed

00000000.
Set Display D.P.

The function also determines the position of the decimal point in the Batch Size, Batch Limit and Pre-Stop functions.

6.5.6 Batch Legend

The units of measurement of the batched volume can be entered with this function. Up to six upper and lower case alphanumeric characters may be used. Some of the operator screens will display this legend against the batch display.

XXXXXX
Set Batch Legend

6.5.7 Batch Limit

To prevent accidental over-filling, the Batch Limit defines the maximum batch that may be dispensed. If a batch setpoint greater than the Batch Limit is entered, it will be accepted but a warning will appear on the screen. The position of the decimal point will be the same as the batch display. See 6.5.5.

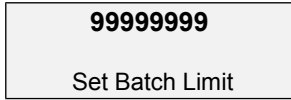

6.5.8 Batch Names

This function enables up to nine pre-entered batch setpoints to be identified with individual names each having up to sixteen alphanumeric characters. The name is displayed when the Batch Size setpoint is selected or adjusted see sections 6.5.9 and 6.5.10. Some of the operator display screens also show the setpoint name.

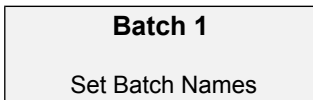

6.5.9 Batch Size

The named batch setpoints can be assigned a value with this function. The position of the decimal point in all the setpoints will be as defined by the Batch D.P. function. - See 6.5.5.

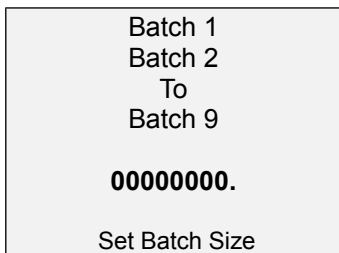

Note: May be included in Operator Menu. See 2.1

6.5.10 Select Batch

This allows the batch controller's operating setpoint to be selected from the nine pre-entered setpoints. To select, highlight the name of the required setpoint and press *E*. The setpoint value will be shown at the bottom of the display screen.

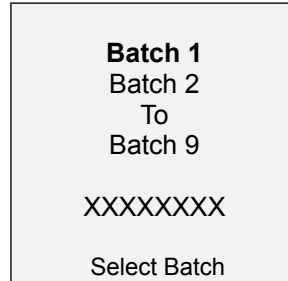

Note: May be included in Operator Menu. See 2.1

6.5.11 Batch History

The volume of product dispensed in the previous nine batches is recorded by this function.

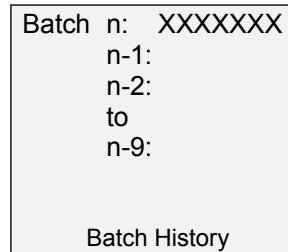

Note: May be included in Operator Menu. See 2.1

6.5.12 CONTROL2delay

(Control 2 Start Delay)

At the start of a batch, Control 1 is energised immediately the *Start* button is operated. Control 2 may be energised at the same time, or delayed for up to 3600 seconds by this function.

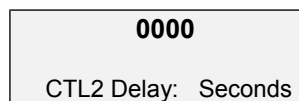

6.5.13 CONTROL2stop (Control 2 Pre-Stop)
Control 1 is de-energised when the batched total equals the batch setpoint. Control 2 may be de-energised at the same time, or a programmable batch quantity before the batch setpoint is reached. This quantity is defined by CONTROL2stop which is displayed in the same units as the batched total.

00000000.
CTL2 Pre-Stop: Counts

6.5.14 CONTROL3delay
(Control 3 Start Delay)

As Control 2 Start delay described in section 6.5.12 except the delay applies to Control 3.

6.5.15 CONTROL3stop (Control 3 Pre-Stop)
As Control 2 Pre-Stop described in section 6.5.13 except this function applies to Control 3.

6.5.16 Count Mode

This function determines whether the batch display counts upwards from zero to the batch size setpoint, or downwards from the batch size setpoint to zero.

Up
Down
Set Count Direction

Highlight the required option and press *E* to enter the selection.

6.5.17 Overrun Compensation

Overrun compensation automatically corrects for time delays in the batching system that may cause product dispensing to continue after Control 1 has been de-energised. The average overrun of the last three batches is used for the correction.

When overrun compensation is selected, the average amount of product dispensed between Control 1 being de-energised and the batch controller being reset is calculated. This quantity is automatically subtracted from the batch setpoint for subsequent batches.

If the flow alarm has been assigned to one of the outputs, overrun compensation will be calculated using the product dispensed between Control 1 being de-energised and the flow alarm being activated or the batch controller being reset, whichever occurs first.

On
Off
Set Compensation

Highlight the required option and press *E* to enter the selection.

6.5.18 Batch Cycles

When the 'Restart' function described in section 6.4.7 is set to 'Auto Restart', this function defines the number of batches that are performed. Any number of cycles up to 10,000 may be entered.

00001
Set No. of Batches

Set the required number of cycles digit by digit and press *E* to enter the value.

6.5.19 Restart Delay

When the 'Restart' function described in section 6.4.7 is set to 'Auto Restart', this function defines the delay between one batch finishing and the next batch starting. Any delay up to 24 hours may be set.

00 : 00 : 00
Restart: hh : mm : ss

Set the required delay time digit by digit and press *E* to enter the value.

BLANK PAGE

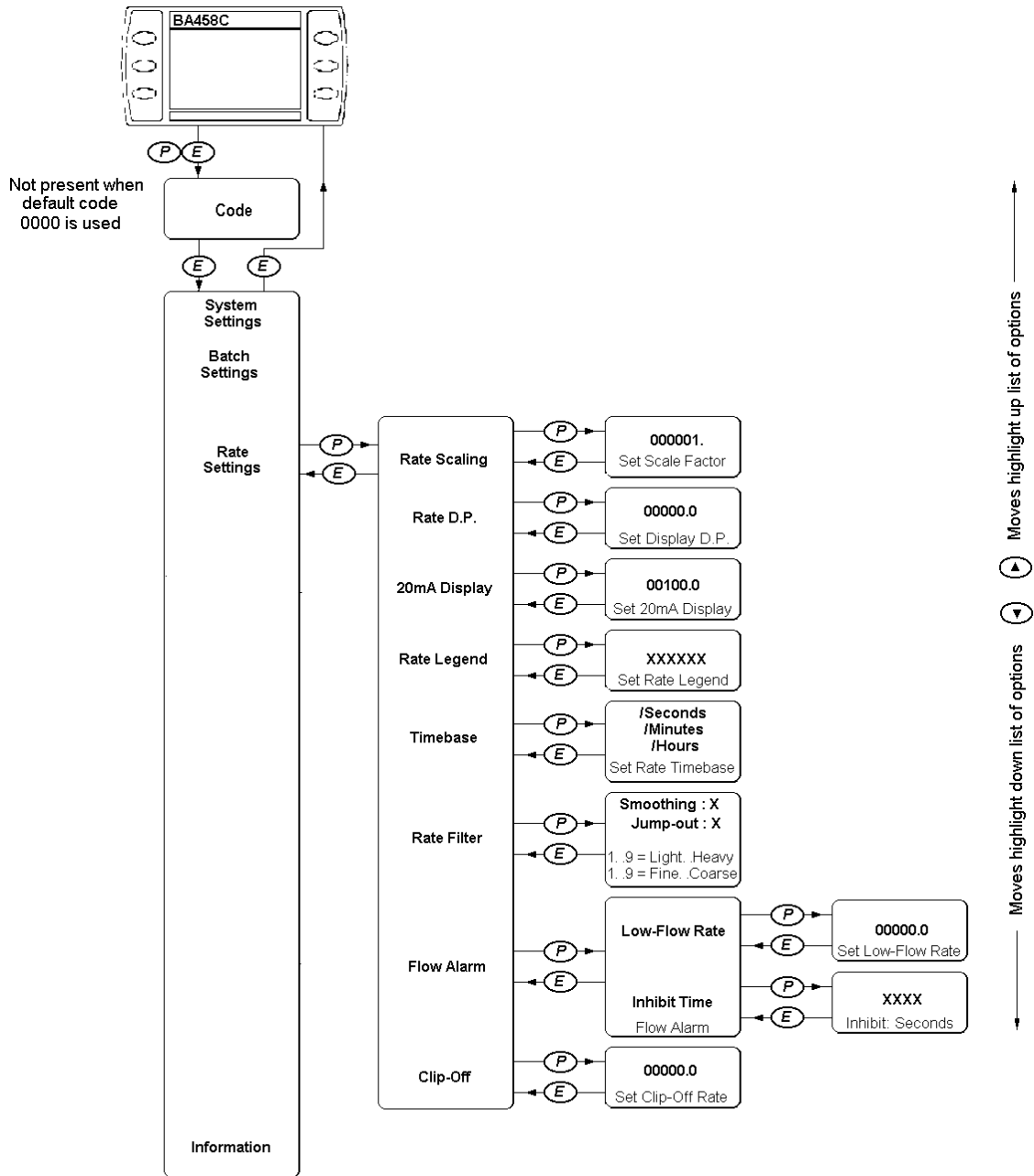

Fig 16 Rate Settings

6.6 RATE SETTINGS

See Fig. 16

6.6.1 Rate Scaling (For pulse inputs)

The Rate Scaling factor, which may be adjusted between 0.001 and 999999, defines the arithmetic relationship between the units of measurement of the batch display and the rate display units of measurement.

$$\text{Rate Scaling Factor} = \frac{\text{Units of rate display}}{\text{Units of batch display}}$$

When calculating the Rate Scaling Factor, the required units of measurement for the rate display must be converted to those used for the batch display as shown in the following example.

The BA458C batch display is in UK gallons but the rate display is required in litres.

$$\text{Rate Scaling Factor} = \frac{\text{Units of rate display}}{\text{Units of batch display}}$$

$$= \frac{1 \text{ litre}}{1 \text{ gallon}}$$

$$= \frac{1 \text{ litre}}{4.5461 \text{ litres}}$$

$$\text{Rate Scaling Factor} = 0.21997$$

If the rate display is required in the same units as the batch display, the Rate Scaling Factor should be set to 1.0

000001. Set Scale Factor

6.6.2 Rate D.P. (For pulse inputs)

The position of the rate display decimal point, which determines the resolution of the display, is set by this function. In operation leading zeros are suppressed

00000.0 Set Display D.P.

6.6.3 20mA Display (For 4/20mA input)

The rate display at 20mA is set with this function. The range of adjustment is between 0.00001 and 999999

00100.0 Set 20mA Display

The display may represent flow per second, per minute or per hour. The units of time are defined by the Timebase, which determines how the measured rate is integrated to produce the batch display. See 6.6.5

6.6.4 Rate Legend

This function enables the units of the rate display to be entered. Up to six upper and lower case alphanumeric characters may be used. Some of the operator screens will display this legend against the rate display.

XXXXXX Set Rate Legend

6.6.5 Timebase

The exact function of the timebase depends upon whether the batch controller is conditioned to receive a pulse input or a 4/20mA analogue input.

Pulse inputs

Number of pulses received is proportional to volume dispensed.

The timebase multiplies the rate display by 60 if flow per minute is to be shown and by 3,600 if flow per hour is to be shown.

4/20mA Analogue input

Amplitude of the input current is proportional to rate of dispensing (flow).

The timebase does not affect the rate display. If the rate display represents flow per minute, the batch display is divided by 60, if the rate display represents flow per hour the batch display is divided by 3,600.

/Second /Minute /Hour Set Rate TimeBase

Highlight the required option and press *E* to enter the selection.

6.6.6 Rate Filter

The BA458C contains a digital filter with two independent adjustable parameters enabling the rate display frequency response to be tailored for optimum performance.

Smoothing

Amount of filtering applied (time constant). Adjustable between 0 and 9, where 0 is no filtering and 9 is maximum filtering.

Smoothing	Filter time constant seconds
0	0
1	1.3
2	4.3
3	6.5
4	8.7
5	11.3
6	15.7
7	20.9
8	25.2
9	31.5

Jump-Out

Defines the deviation from the displayed rate at which the filter will be overridden and the rate display will move rapidly to the new value.

Jump-Out	Magnitude of step change which will produce a rapid response
0	Off
1	1%
2	2%
3	4%
4	8%
5	12%
6	16%
7	24%
8	32%
9	64%

By careful adjustment of the two parameters a stable display with an acceptable step input response can be obtained for most applications.

During commissioning it is recommended that initially Jump-Out is set to 0 (off) and Smoothing is adjusted to provide acceptable rate display stability. Jump-Out should then be increased until the selected step size is greater than the noise on the display signal, at which setting the rate display will again become stable. These will be the optimum filter parameters for acceptable rate display stability and a fast response to a large rate signal change.

Smoothing: **2**
Jump-Out: **4**

1..9 = Light..Heavy /
1..9 = Fine..Coarse

6.6.7 Flow Alarm

The flow alarm may be assigned to any of the batch controller outputs – See section 6.4.8. When the flow rate falls below the flow alarm setpoint, the assigned output will close, the BA458C will enter a pause condition and the display will show 'Paused – Low Flow'.

To prevent false alarms at the start of a batch while the flow rate increases, the flow alarm may be inhibited for between 1 and 3,600 seconds after the batch is started.

Low-Flow Rate
Inhibit Time

Flow Alarm

Highlight the 'Low-Flow Rate' option and operate the *P* pushbutton, which will result in the 'Set Low-Flow Rate' screen being displayed with the decimal point positioned as already specified. Set the required alarm setpoint digit by digit then press *E* to enter the value and return to the 'Flow Alarm' screen.

If the alarm is to be inhibited while the batch is starting, highlight the 'Inhibit Time' option and operate the *P* pushbutton which will result in the 'Inhibit: Seconds' screen being displayed. Set the required inhibit time digit by digit and then press *E* to enter the value and return to the 'Flow Alarm' screen.

6.6.8 Clip-Off

To prevent the batch total being incremented at very low flow rates where flowmeters may be less accurate, the BA458C incorporates an adjustable clip-off function. At flow rates below the adjustable clip-off threshold, the rate display is forced to zero and the batch display is not incremented.

00000.0

Set Clip-off Rate

7. CALIBRATION EXAMPLE

In this example a BA458C batch controller is required to control the dispensing of a liquid into a tank as shown in Fig. 17. It is a stand-alone system so galvanic isolators have been used for the interface between the safe and hazardous area. The batch controller is powered by an isolator with a 28V, 93mA output safety description. Two more identical devices are used to power the intrinsically safe solenoid valves that are controlled by Control 1 and Output 2. Output 3, which is configured as a flow alarm, is connected to a switch transfer isolator which produces a switch contact closure in the safe area.

The BA358C batch controller is required to:

Dispense 1,000 or 500 litres of product into a tank having a maximum capacity of 1,100 litres. Two volumes to be identified Full volume and Half volume respectively.

The flowmeter incorporates a proximity detector and produces an output of 25 pulses per litre.

Display the dispensed total with a resolution of 0.1 litres.

Batch Controller to count upwards from zero to the batch setpoint.

Control two parallel valves (2 stage control).

At start of the batch valve 2 is to open 10 seconds after valve 1 and to close when 50 litres of product remain to be dispensed.

Compensate for errors resulting from actuator delays.

Initiate an alarm if the flow rate falls below 0.2 litres per second. Alarm to be inhibited for the first 20 seconds of the batch.

Operator needs to select the batch size from the operator menu, but must not be able to adjust the two setpoints. The operator requires access to the history of the last ten batches but must not have access to the configuration menu.

The process is to be controlled by the batch controller's front panel switches. The Reset function is not required.

The Operator Menu is not to be protected by a security code, but the Configuration Menus are to be protected by code 1209.

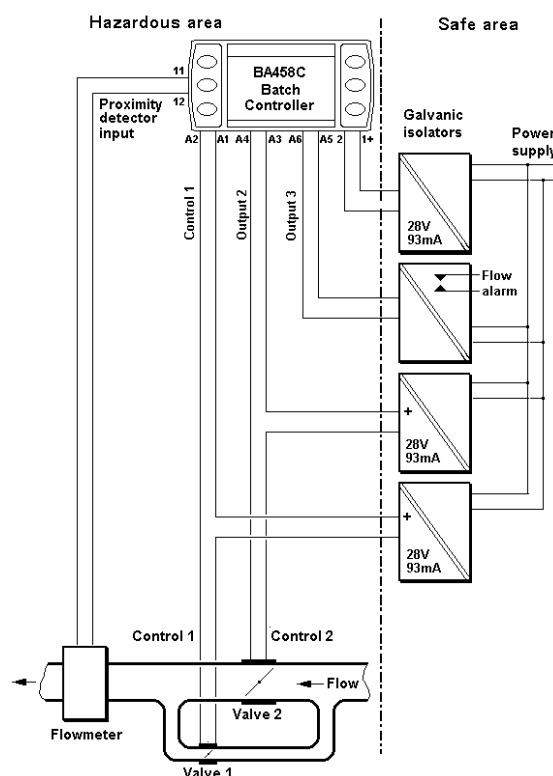

Fig 17 Liquid dispensing system

System Settings

Function	Setting
Language	English
User Controls	Local
Signal Input	Prox Detector
Lineariser	Off
Restart	Quick
Output 2	Control 2
Output 3	Flow Alarm
Clear Grand Total	Yes
Security	
Config Code	1209
Operator Code	0000
Operator Menu	Batch Sizing Off
	Batch Select On
	History On
	Config Menu Off
Operator Screens	Screen 1

Batch Settings

Function	Setting
Scale Factor	25
Batch D.P.	0000000.0
Batch Legend	Litres
Batch Limit	1050.0
Batch Names	Batch 1 Full Volume Batch 2 Half Volume
Batch Size	Full Volume 1000.0 Half Volume 500.0
CONTROL2delay	10 seconds
CONTROL2stop	50.0
Count Mode	Up
Overrun Comp	On

Rate Settings

Function	Setting
Rate Scaling	1.0
Rate D.P.	00000.0
Rate Legend	L / s
Timebase	/Second
Rate Filter	Smoothing 2 Jump-Out 4
Flow Alarm	Low-Flow Rate 0.2
Inhibit Time	0020
Clip-Off	00000.0

8. MAINTENANCE

8.1 Fault finding during commissioning

If a BA458C fails to function during commissioning the following procedure should be followed:

Symptom	Cause	Check:
No Display	No Power Incorrect wiring No Zener barrier, galvanic isolator or resistor in series with power supply. See 4.2.1	That there is at least 11 volts between terminal 1 and 2. Terminal 1 should be positive.
Front panel pushbuttons do not function.	Batch controller conditioned to operate with remote switches.	User Controls configuration.
BA458C will not count input pulses or integrate 4/20mA input.	Input not correctly configured. Input connected to wrong terminals or reversed. Incorrect electrical level	Signal input configuration. Input terminals That pulse input exceeds batch controller's input switching thresholds. 4/20mA loop can tolerate 0.6V drop introduced by the batch controller.
Control 1 is not energised and screen does not display 'Running' when Start button is operated.	Batch size setpoint not entered.	Batch setpoint. Enter or select the correct batch setpoint.
BA458C continues to count after batch size setpoint is reached.	The BA458C will only stop counting when input pulses stop, or 4/20mA input current falls to 4mA.	Note: The control loop must be closed so that the batch controller output(s) control the input signal.
Configuration menus are not accessible.	Security link missing and / or security code not entered.	That terminals 18 & 19 are joined together. Enter four digit security code.
Function missing from sub-menu.	Functions dependent on higher level functions are removed from the menu if the higher level function is not selected.	That related higher level function has been selected.
Batch controller is not performing as anticipated.	Incorrect configuration.	Information menu that lists all the configuration settings.

The Information sub-menu, which is described in section 6.2 and Appendix 2, lists all the batch controller configuration settings. This provides a rapid way of checking that the instrument has been correctly configured.

8.2 Fault finding after commissioning

ENSURE PLANT SAFETY BEFORE STARTING MAINTENANCE

Live maintenance is permitted on intrinsically safe equipment installed in a hazardous area, but only certified test equipment should be used unless a gas clearance certificate is available.

If a BA458C fails after it has been functioning correctly, the table shown in section 8.1 may help to identify the cause of the failure.

If this procedure does not reveal the cause of the fault, please contact BEKA or our local agent.

8.3 Servicing

We recommend that faulty BA458C batch controllers are returned to BEKA associates or to our local agent for repair.

8.4 Routine maintenance

The mechanical and electrical condition of the instrument should be regularly checked. Initially annual inspections are recommended, but the inspection frequency should be adjusted to suit the environmental conditions.

See sections 6.4.4 and 6.4.5 if the batch controller's 4/20mA input is being used.

8.5 Guarantee

Instruments which fail within the guarantee period should be returned to BEKA associates or our local agent. It is helpful if a brief description of the fault symptoms is provided.

8.6 Customer comments

BEKA associates is always pleased to receive comments from customers about our products and services. All communications are acknowledged and whenever possible, suggestions are implemented.

9. ACCESSORIES

9.1 Tag number

The BA458C can be supplied with a thermally printed tag number on the rear panel. This tag number is not visible from the front of the instrument after installation.

10. INDEX

Subject	Section	Subject	Section
ATEX Directive	3.1, 3.8	Maintenance	8.
Backlight	6.4.3, 6.4.16	Menu	
Batch		Batch settings	6.5
Cycles	6.5.18	Configuration	6.
Decimal point D.P.	6.5.5	Operator	2.1
History	6.5.11	Rate settings	6.6
Legend	6.5.6	System	6.4
Limit	6.5.7	Operator	
Names	6.5.8	Controls	2.1
Select	6.5.10	Display	6.4.16
Size	6.5.9	Screens	6.4.15, Appendix 1
Status	6.4.17.5	Output	
Calibration		2	6.4.8
4mA	6.4.4	3	6.4.9
20mA	6.4.5	4, 5 & 6 (optional)	6.4.10
Example	7.	Options	6.4.17
Certificates		Batch status	6.4.17.5
EC Type-Examination	3.1	Control 2	6.4.17.1
System	4.1	Control 3	6.4.17.2
Certification label	3.8	Flow alarm	6.4.17.3
Clip-off	6.6.8	Pulse output	6.4.17.6
Configuration		Reset status	6.4.17.4
Batch	6.5	Overrun compensation	6.5.17
Default	6.3	Power supply	3.3, 4.2.1, 4.3.1
Rate	6.6	Failure of	2.2
System	6.4	Pulse output	6.4.11, 6.4.17.6
CONTROL2delay	6.5.12	Rate settings	6.6
CONTROL3delay	6.5.14	Decimal point D.P.	6.6.2
CONTROL2stop	6.5.13	Filter	6.6.6
CONTROL3stop	6.5.15	Legend	6.6.4
Count mode	6.5.16	Scaling (pulse input)	6.6.1
Defaults	6.4.13	Timebase	6.6.5
EMC	5.3	Reset	
External switches	3.6, 4.4	Pushbutton	2.1
Flow alarm	6.6.7, 6.4.17.3	Status	6.4.17.4
Galvanic isolators	4.3	Restart	6.4.7
Gas groups	3.2	Delay	6.5.19
Grand total	6.4.12, Appen. 2	Security	6.1, 6.4.14
Information sub-menu	Appendix 2	Link	3.7, 4.6
Inhibit link	3.7, 4.5	Scale factors	6.5.2, 6.5.3
Inputs	3.4, 4.2.2, 4.3.2	Scale points	6.5.1
Analogue 4/20mA	4.2.3	Scaling	6.5.4
Proximity detector	4.2.2.2	Signal input	6.4.3
Switch contact	4.2.2.1	Start pushbutton	2.1
Voltage pulse	4.2.2.3	Stop pushbutton	2.1
Installation procedure	5.2	Switch outputs	3.5, 4.2.4, 4.3.3
Intrinsic safety	3.	Tag number	9.1
Language	6.4.1	T rating	3.2
Lineariser	6.4.6	User controls	6.4.2
Location	5.1	Zener barriers	4.2
		Zones	3.2

Appendix 1 Operator display screens

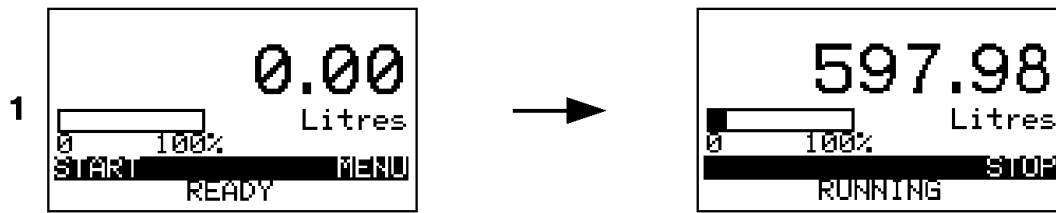

Shows batch quantity, units of measurement & bargraph depicting batch progress.

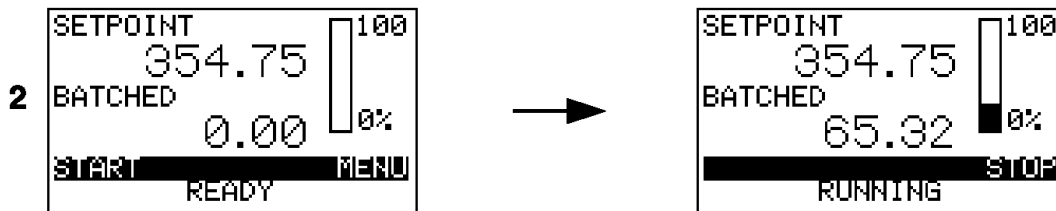

Shows batch setpoint, batched quantity & bargraph depicting batch progress.

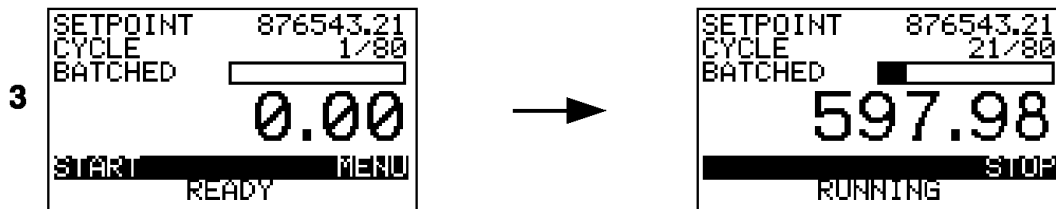

Shows batch setpoint, batched quantity and bargraph depicting progress. When autostart is used, also shows current batch number and number of batches requested.

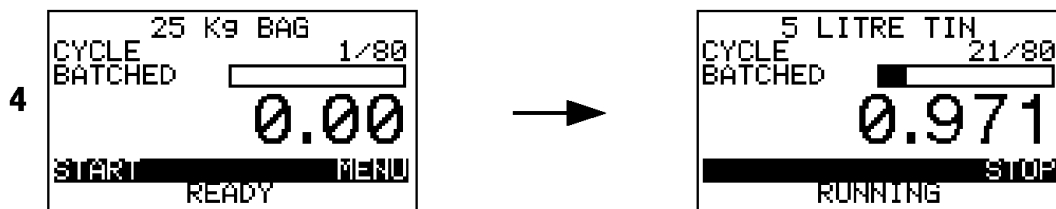

Shows setpoint name, batched quantity and bargraph depicting progress. When autostart is used, also shows current batch number and number of batches requested.

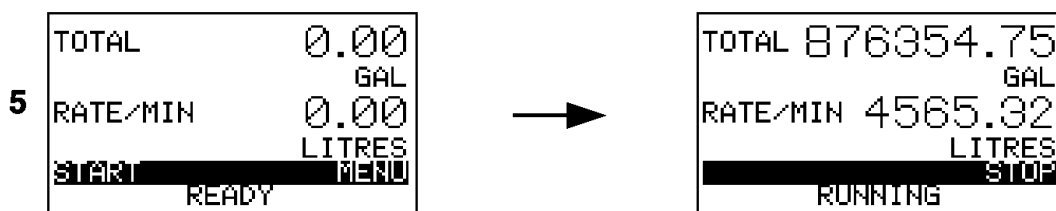

Shows batched quantity and units of measurement plus rate of dispensing and units of measurement.

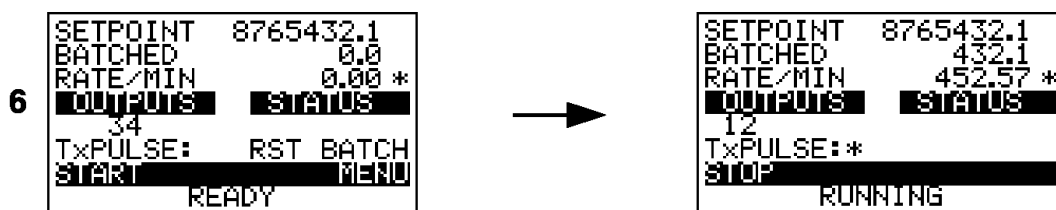

Commissioning screen shows, batched quantity and rate of dispensing plus status of all outputs.

Appendix 1 Continued

Explanation of commissioning screen 6

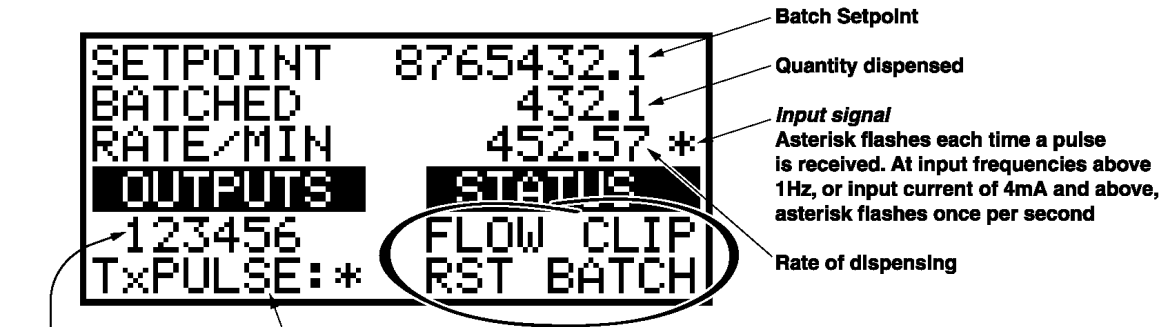

Number is displayed when associated output is energised (closed). **Note:** Output 1 is dedicated to control 1

Pulse output. Asterisk flashes each time pulse is transmitted. At output frequencies above 2Hz asterisk is permanently displayed.

<i>Status Annunciator</i>	<i>Annunciator function</i>	<i>Output status - if assigned</i>
FLOW	Annunciator activated while flow rate is below flow alarm setpoint.	Output closed while flow rate is below flow alarm setpoint.
CLIP	Annunciator activated while flow rate is below pre-set clip-off threshold.	Can not be assigned to an output.
RST	Reset Status Annunciator activated when batch controller is reset and remains activated until next batch is started. i.e While controller screen is displaying 'Ready'.	Output opens when batch is started and closes when batch controller is reset.
BATCH	Batch Status Annunciator activated when batch is started and remains activated until batch is complete.	Output opens when batch is started and closes when batch is complete.

NOTE: Status annunciator is displayed irrespective of assignment to an output.

APPENDIX 2 Information menu

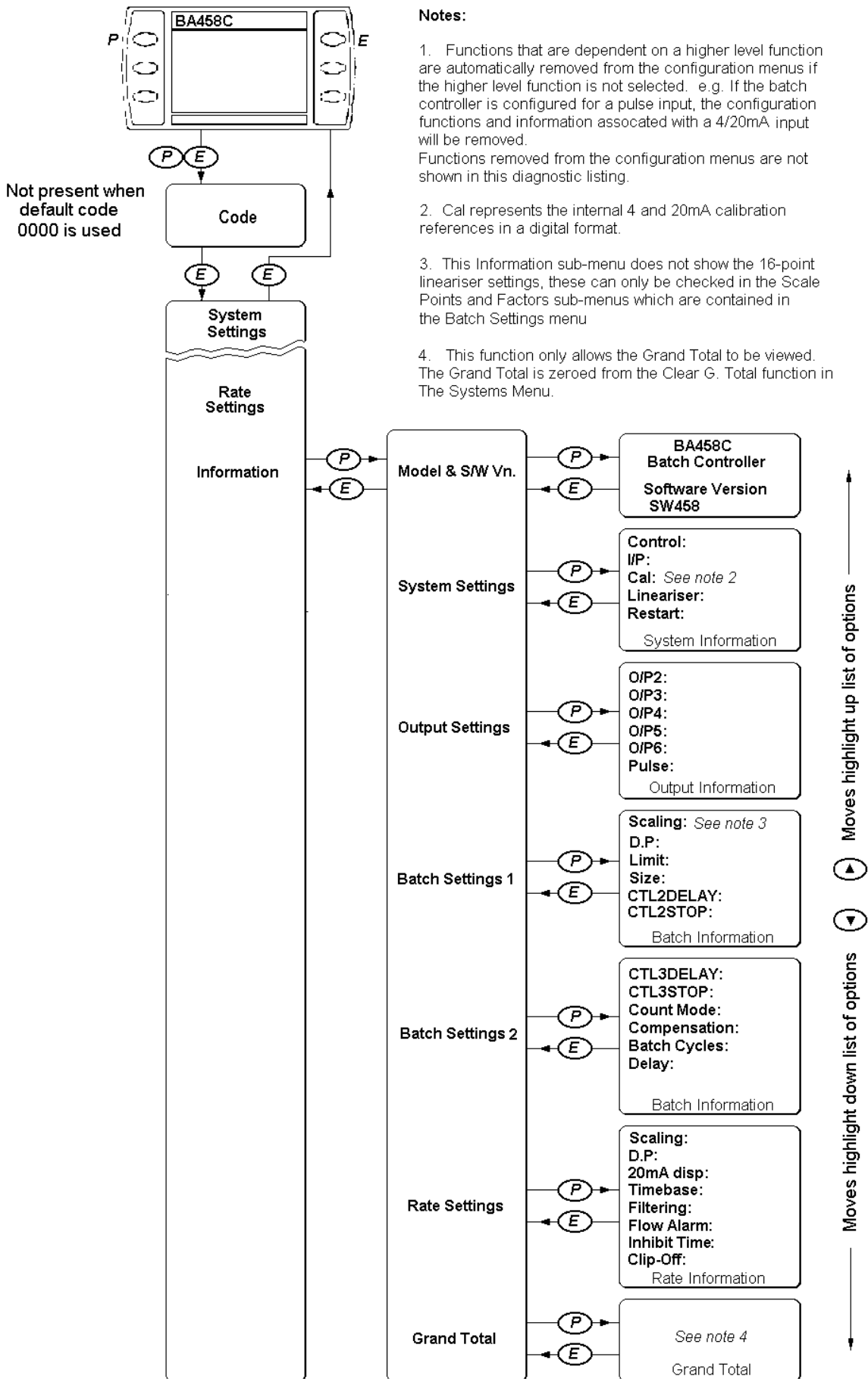

Appendix 3 FM & cFM Approval for use in the USA & Canada.

A4.0 Factory Mutual Approval

For installation in the USA and Canada the BA458C has been approved intrinsically safe and nonincendive by FM Approvals, project identification 3033262. Copies of the Certificates of Compliance are available from the BEKA associates sales office, or may be downloaded from www.beka.co.uk

A4.1 Intrinsic safety approval

The BA458C batch controller is approved to the FM Class 3600 intrinsic safety Standard and Canadian Standard C22.2. Installations should comply with BEKA associates Control Drawing CI450-12 that is attached to this appendix.

A4.2 Nonincendive approval

The BA458C batch controller is also approved to the FM Class 3610 Nonincendive Standard and Canadian Standard C22.2. Installations should comply with BEKA associates Control Drawing CI450-13 that is attached to this appendix.

Note:

When powered from a 24V dc supply without a Zener barrier or a galvanic isolator, a 330ohm 1W resistor should be connected in series with terminal 1.



THIRD ANGLE PROJECTION

DIMENSIONS IN mm

DO NOT SCALE

HAZARDOUS (CLASSIFIED) LOCATION

BA454D LOCATIONS:

- Class I, Division 1, Groups A, B, C, D
- Class II, Division 1, Groups E, F & G
- Class III
- Class I, Zone 0, Group IIC

BA458C LOCATIONS:

- Class I, Division 1, Groups A, B, C, D
- Class I, Zone 0, Group IIC

BA454D and BA458C Entity Parameters	
Terminals 1 & 2	
Ui = 28V	Io = 14.7V dc
Ii = 96mA	Io = 146.7mA dc
PI = 0.84W	Po = 0.58W
CI = 15nF	Co = 0.08µF
LI = 8µH	Lo = 1.1mH
Terminals S1 to S7 (combined parameters)	
Ui = 0	Uo = 14.7V dc
Ii = 0	Io = 146.7mA dc
PI = 0	Po = 0.58W
CI = 0.54µF	Co = 0.08µF
LI = 0.3mH	Lo = 1.1mH
Terminals A1 & A2; A3 & A4; A5 & A6; A7 & A8; A9 & A10; A11 & A12 (for each output)	
Ui = 28V dc	Uo = 1.49V dc
Ii = 200mA dc	Io = 1µA dc
PI = 0.85W	Po = 3µW
CI = 0.04µF	Co = 1000µF
LI = 0.02mH	Lo = 1000mH
Terminals 11 & 12	
Ui = 0	Uo = 10.6V
Ii = 0	Io = 20mA
PI = 0	Po = 50mW
CI = 15nF	Co = 2.3µF
LI = 8µH	Lo = 90mH
Terminals 13, 14, 15, 16 & 17	
Ui = 28V dc	Uo = 1.1V
Ii = 100mA	Io = 0.12mA
PI = 0.66W	Po = 35µW
CI = 18nF	Co = 0.18µF
LI = 20mH	Lo = 0.02mH
Terminals 18, 19 & 20	
Ui = 0	Uo = 11.7V
Ii = 0	Io = 2.4mA
PI = 0	Po = 7mW
CI = 3.6nF	Co = 1000µF
LI = 0	Lo = 1000mH

***** NOTE: *****
 * No modification to be made without
 * reference/approval from FM Approvals
 * and BEKA associates Design Department.*

UNCLASSIFIED LOCATION

SEE NOTE 1

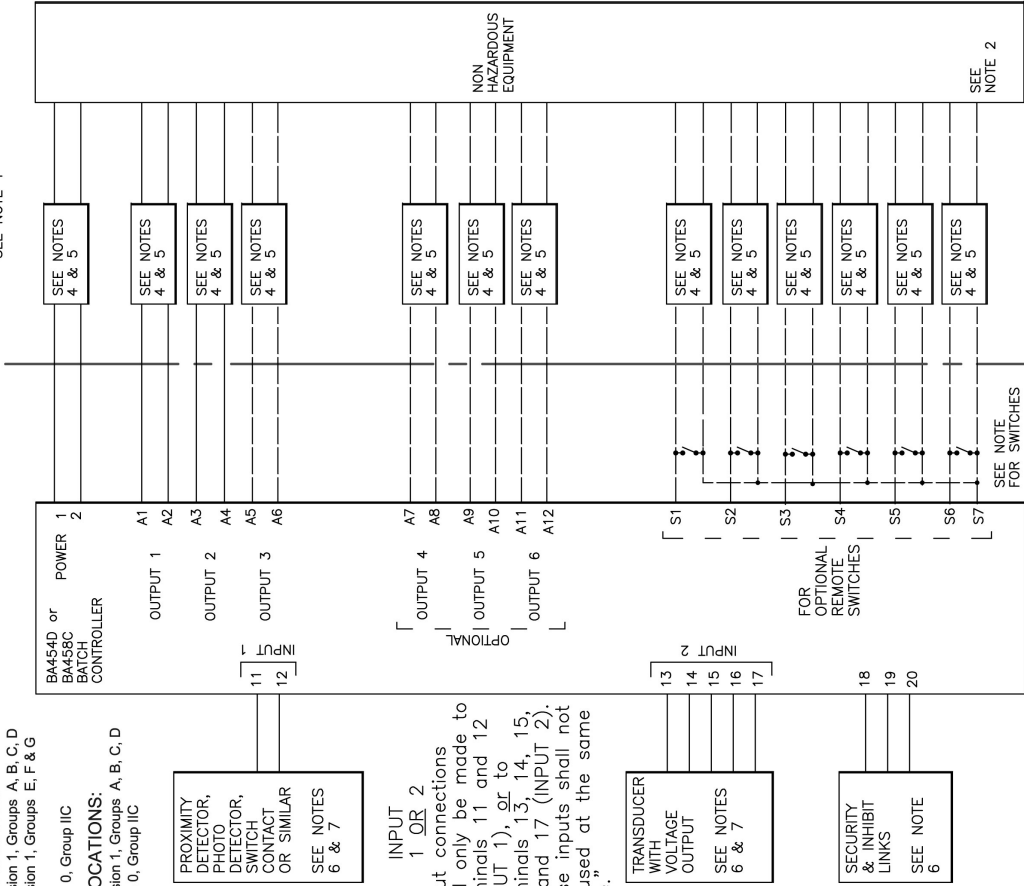

"Input connections shall only be made to terminals 11 and 12 (INPUT 1), or to terminals 13, 14, 15, 16 and 17 (INPUT 2). These inputs shall not be used at the same time."

INPUT IN HAZARDOUS (CLASSIFIED) LOCATION

BEKA associates
 Hitchin
 England
 company confidential, copyright reserved.

FM Approvals Control Drawing for
 Intrinsically safe BA454D & BA458C
 Batch Controller

Drawn	SH	Checked	Scale
Drawing No.			NTS
Sheet 1 of 4			CI450-12

1	26.03.2008	First release		
Iss.	Date	Modification	Ckd.	Appd.

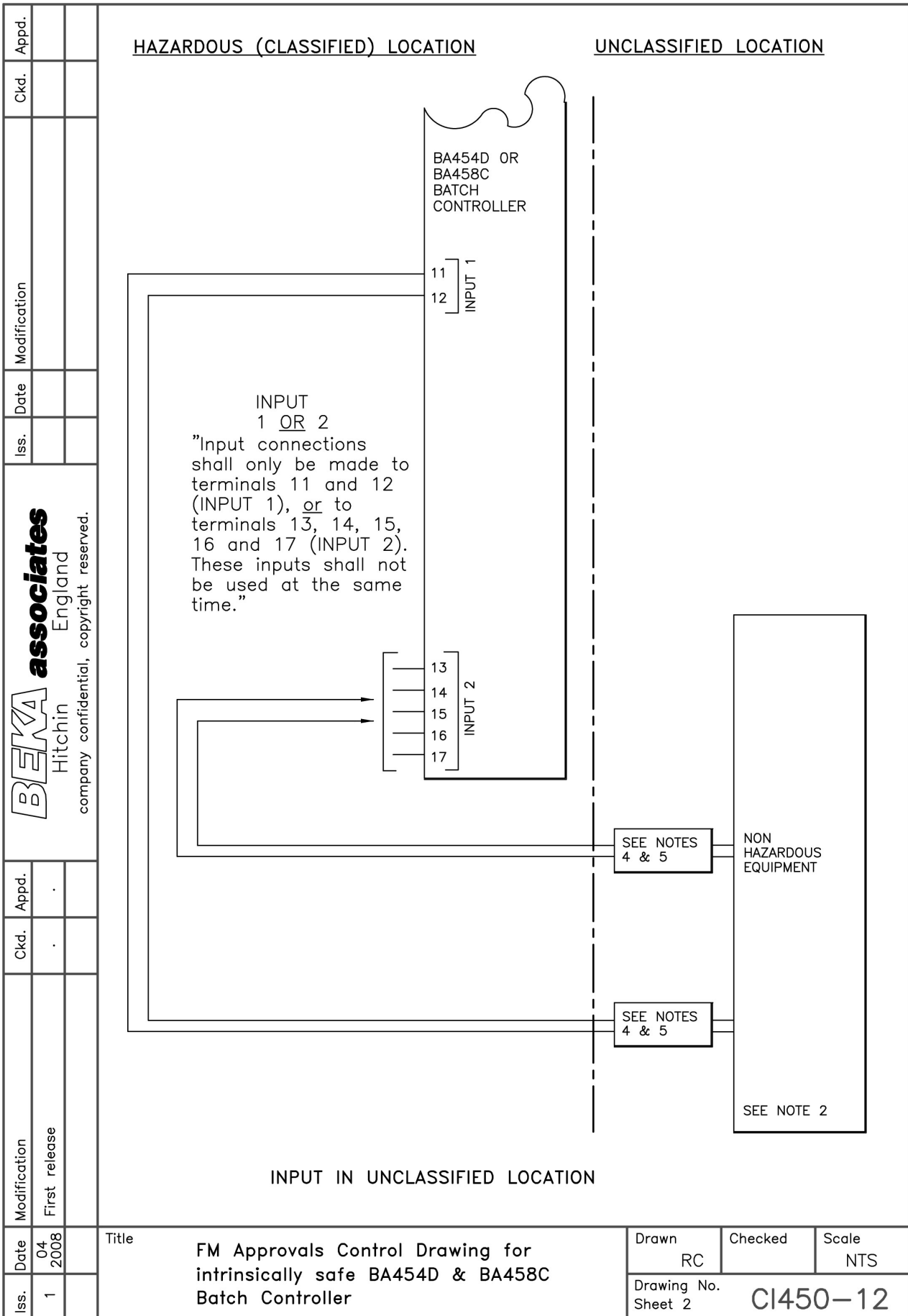

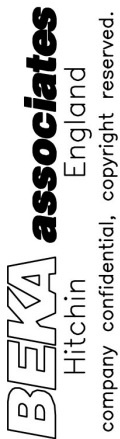
Appd.																																			
Ckd.																																			
Modification																																			
Date																																			
Iss.																																			
<div style="display: flex; justify-content: space-between; align-items: center;"> <div style="text-align: center;">  <p>BEKA associates England Hitchin company confidential, copyright reserved.</p> </div> <div style="width: 80%;"> <p>***** Note: No modification to be made without reference/approval from FM Approvals and BEKA associates Design Department. *****</p> <p>Notes:</p> <ol style="list-style-type: none"> The associated intrinsically safe barriers and galvanic isolators must be FM approved and the manufacturers' installation drawings shall be followed when installing this equipment. For installations in Canada the associated intrinsically safe barriers and galvanic isolators must be cFM or CSA approved and the manufacturers' installation drawings shall be followed when installing the equipment. The unclassified location equipment connected to the associated intrinsically safe Zener barriers or galvanic isolators shall not use or generate more than 250V rms or 250V dc. Installation shall be in accordance with ANSI/ISA RP 12.06.01 "Installation of Intrinsically Safe Systems for Hazardous (Classified) Locations" and the National Electrical Code ANSI/NFPA 70. Installations in Canada shall be in accordance with the Canadian Electrical Code C22.1 One single channel or one channel of a dual channel associated intrinsically safe barrier or galvanic isolator with entity parameters complying with the following requirements: <table style="width: 100%; border: none;"> <tr> <td style="padding-right: 20px;">Uo or Vt</td> <td style="padding-right: 20px;">equal to or less than</td> <td>Ui</td> </tr> <tr> <td>Io or It</td> <td>equal to or less than</td> <td>li</td> </tr> <tr> <td>Lo</td> <td>equal to or greater than</td> <td>Lcable + Li</td> </tr> <tr> <td>Co</td> <td>equal to or greater than</td> <td>Ccable + Ci</td> </tr> </table> All shunt Zener diode safety barriers and diode return barriers must be of like polarity. The electrical circuit and the interconnecting cables in the hazardous (classified) location must be cable of withstanding an ac test voltage of 500Vrms to ground or frame of the apparatus for one minute. Hazardous (classified) location equipment may be simple apparatus as defined in the National Electrical Code or the Canadian Electrical Code e.g. mechanically activated switches OR FM Approved equipment with entity parameters complying with following requirements: <table style="width: 100%; border: none;"> <tr> <td style="padding-right: 20px;">Uo or Vt</td> <td style="padding-right: 20px;">equal to or less than</td> <td>Ui</td> </tr> <tr> <td>Io or It</td> <td>equal to or less than</td> <td>li</td> </tr> <tr> <td>Lo</td> <td>equal to or greater than</td> <td>Lcable + Li</td> </tr> <tr> <td>Co</td> <td>equal to or greater than</td> <td>Ccable + Ci</td> </tr> </table> </div> </div>												Uo or Vt	equal to or less than	Ui	Io or It	equal to or less than	li	Lo	equal to or greater than	Lcable + Li	Co	equal to or greater than	Ccable + Ci	Uo or Vt	equal to or less than	Ui	Io or It	equal to or less than	li	Lo	equal to or greater than	Lcable + Li	Co	equal to or greater than	Ccable + Ci
Uo or Vt	equal to or less than	Ui																																	
Io or It	equal to or less than	li																																	
Lo	equal to or greater than	Lcable + Li																																	
Co	equal to or greater than	Ccable + Ci																																	
Uo or Vt	equal to or less than	Ui																																	
Io or It	equal to or less than	li																																	
Lo	equal to or greater than	Lcable + Li																																	
Co	equal to or greater than	Ccable + Ci																																	
Date	26.03 2008	Modification	First release	Ckd.	.	Appd.	.	Title																											
Iss.	1	FM Approvals Control Drawing for intrinsically safe BA454D & BA458C Batch Controller				Drawn	RC	Checked	Scale		NTS																								
						Drawing No.	CI450-12																												
						Sheet 3																													

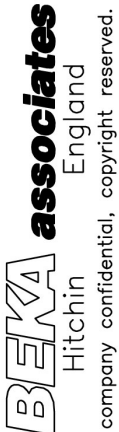
						 <p>company confidential, copyright reserved.</p>									
Iss.	Date	Modification	Ckd.	Appd.											
Iss.	Date	Modification	Ckd.	Appd.											
Iss.	Date	Modification	Ckd.	Appd.											
						<p>8. Optional switches which comply with the requirements for simple apparatus as defined in the National Electrical Code or the Canadian Electrical Code.</p> <p>9. To maintain IP66 protection between the BA458C batch controller and the mounting panel:</p> <p style="margin-left: 40px;">Four panel mounting clips shall be used</p> <p style="margin-left: 40px;">Minimum panel thickness shall be 2mm (0.08inches) Steel 3mm (0.12inches) Aluminium</p> <p style="margin-left: 40px;">Outside panel finish shall be smooth, free from particle inclusions, around cut-out.</p> <p style="margin-left: 40px;">Panel cut-out shall be 66.2 x 136.0mm -0.0 +0.5 (2.60 x 5.35 inches -0.00 +0.02)</p> <p style="margin-left: 40px;">Edges of panel cut-out shall be deburred and clean</p> <p style="margin-left: 40px;">Each panel mounting clip shall be tightened to between: 20 and 22cNm (1.77 to 1.95 inLb)</p> <p>10. When installed in a hazardous (classified) location the BA454D Batch Controller shall be fitted with cable glands/conduit hubs selected from the following table</p> <p style="margin-left: 40px;">Metallic glands and hubs must be grounded - see note 11.</p> <table border="1" style="width:100%; border-collapse: collapse;"> <thead> <tr> <th style="width:20%;">Class</th> <th style="width:80%;">Permitted gland or conduit hub</th> </tr> </thead> <tbody> <tr> <td style="text-align:center;">Class I</td> <td>Any metallic or plastic cable gland or conduit hub that provides the required environmental protection.</td> </tr> <tr> <td style="text-align:center;">Class II and III</td> <td> <p>Crouse - Hinds Myler hubs ST-1 STA-1 SSTG-1 STG-1 STAG-1 MHUB-1 HUB-1</p> <p>O-Z / Gedgefrey Hubs CHM-50DT CHMG-50DT</p> <p>Killark Glands CMCXAA050 MCR050 MCX050</p> </td> </tr> </tbody> </table>	Class	Permitted gland or conduit hub	Class I	Any metallic or plastic cable gland or conduit hub that provides the required environmental protection.	Class II and III	<p>Crouse - Hinds Myler hubs ST-1 STA-1 SSTG-1 STG-1 STAG-1 MHUB-1 HUB-1</p> <p>O-Z / Gedgefrey Hubs CHM-50DT CHMG-50DT</p> <p>Killark Glands CMCXAA050 MCR050 MCX050</p>			
Class	Permitted gland or conduit hub														
Class I	Any metallic or plastic cable gland or conduit hub that provides the required environmental protection.														
Class II and III	<p>Crouse - Hinds Myler hubs ST-1 STA-1 SSTG-1 STG-1 STAG-1 MHUB-1 HUB-1</p> <p>O-Z / Gedgefrey Hubs CHM-50DT CHMG-50DT</p> <p>Killark Glands CMCXAA050 MCR050 MCX050</p>														
						<p>11. In addition to the supplied bonding plate, when metallic 2 or 3 glands or conduit hubs are fitted to a BA454D Batch Controller, all metallic glands or conduit hubs must be connected together and grounded.</p> <p>12. WARNING: The BA454D and BA458C Batch Controllers are manufactured from conductive plastic per Article 250 of the National Electrical Code or Section 10 of the Canadian Electrical Code as applicable. The enclosures shall be grounded using the 'E' terminal on the terminal block.</p> <p>13. Input connections shall only be made to terminals 11 and 12 (INPUT 1), or to terminals 13, 14, 15, 16 and 17 (INPUT 2). These inputs shall not be used at the same time.</p> <p>14. The terminals for the power supply, Input A or Input B, External Links, External Switches, and optional alarms are all considered to be different intrinsically safe circuits and shall be wired separately as required by the National Electrical Code or Canadian Electrical Code as applicable.</p>									
	Date 26.03 2008	Modification First release	Title			Drawn RC	Checked	Scale NTS							
	Iss. 1		FM Approvals Control Drawing for intrinsically safe BA454D & BA458C Batch Controller			Drawing No. Sheet 4		CI450-12							



THIRD ANGLE PROJECTION

DIMENSIONS IN mm

DO NOT SCALE

HAZARDOUS (CLASSIFIED) LOCATION

UNCLASSIFIED LOCATION

SEE NOTE 2

BA454D and BA458C
Maximum input and output parameters

Terminals 1 & 2
Vmax = 28V
Ci = 15nF
Li = 8µH

Terminals S1 to S7
(combined parameters)
Voc = 14.7V dc
Vmax = 0
Isc = 146.7mA
Co = 0.08µF
Lo = 1.1mH

Terminals A1 & A2; A3 & A4;
A5 & A6; A7 & A8; A9 & A10;
A11 & A12 (for each output)
Vmax = 32V dc
Ci = 0.04µF
Li = 0.02mH

Terminals 11 & 12
Vmax = 0
Voc = 10.6V
Isc = 20mA
Co = 2.3µF
Lo = 90mH

Terminals 13, 14, 15, 16 & 17
Vmax = 28V dc
Ci = 18nF
Li = 0.02mH

Terminals 18, 19 & 20
Vmax = 0
Voc = 11.7V dc
Isc = 24mA
Co = 1000µF
Lo = 1000mH

* NOTE:
* No modification to be made without
* reference/approval from FM Approvals
* and BEKA associates Design Department *

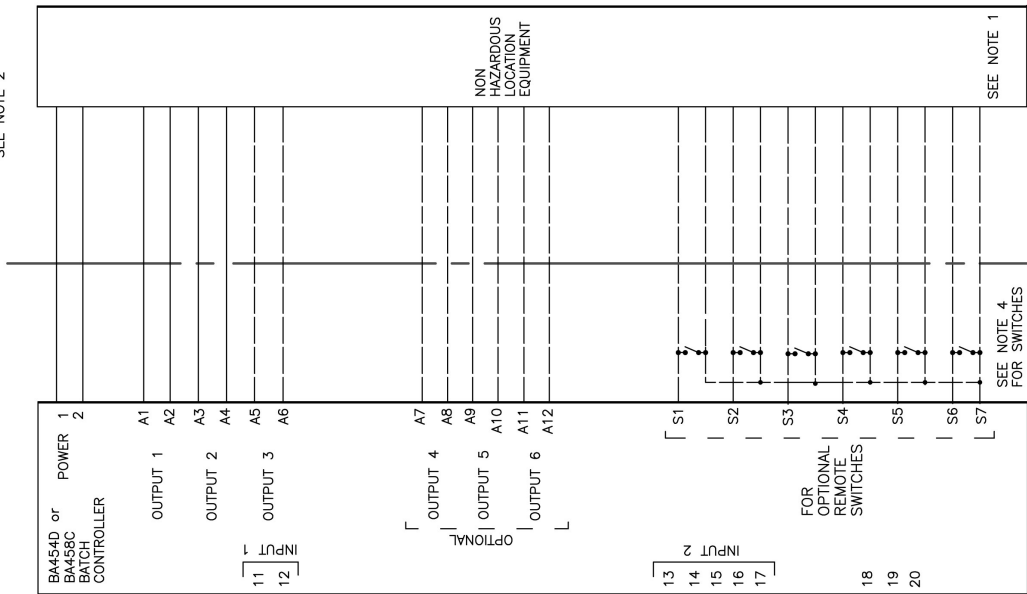

SEE NOTE 4 FOR SWITCHES

SEE NOTE 1

INPUT IN HAZARDOUS (CLASSIFIED) LOCATION

BEKA associates
Hitchin
England
company confidential, copyright reserved.

FM Approvals Control Drawing for nonincendive BA454D & BA458C Batch Controller

Drawn	SH	Checked	Scale
Drawing No.	Sheet 1 of 3		NTS
			CI450-13

1	26.03.2008	First release		
Iss.	Date	Modification	Ckd.	Appd.

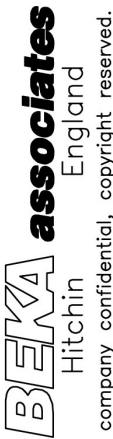
				Appd.												
				Ckd.												
		Modification														
		Date														
		Iss.														
 <p>BEKA associates Hitchin England company confidential, copyright reserved.</p>																
		Modification	First release													
		Date	04 2008													
		Iss.	1													
<p>***** Note: No modification to be made without reference/approval from FM Approvals and BEKA associates Design Department. *****</p> <p>Notes:</p> <p>1. The unclassified location equipment connected to the associated nonincendive field wiring apparatus must not use or generate more than 250V rms or 250V dc.</p> <p>2. Nonincendive field wiring installations shall be in accordance with the National Electrical Code ANSI/NFPA 70. The Nonincendive Field Wiring concept allows interconnection of Nonincendive Field Wiring Apparatus with Associated Nonincendive Field Wiring Apparatus using any of the wiring methods permitted for unclassified locations. Installations in Canada shall be in accordance with Canadian Electrical Code C22.2</p> <p>3. Apparatus connected to the outputs shall be FM, cFM or CSA Approved as Associated Nonincendive Field Wiring Apparatus and shall comply with the following requirements:</p> <table style="margin-left: 40px; border: none;"> <tr> <td style="padding-right: 40px;">Voc</td> <td style="padding-right: 40px;">equal to or less than</td> <td>Vmax</td> </tr> <tr> <td>La</td> <td>equal to or greater than</td> <td>Lcable + Li</td> </tr> <tr> <td>Ca</td> <td>equal to or greater than</td> <td>Ccable + Ci</td> </tr> </table> <p>4. Terminals S1 to S7 shall be connected to simple apparatus or volt free contacts of FM, cFM or CSA Approved Nonincendive Field Wiring Apparatus or FM, cFM or CSA Approved Associated Nonincendive Field Wiring Apparatus installed using Division 2 wiring methods.</p> <p>5. To maintain IP66 protection between the BA458C and the mounting panel:</p> <p style="padding-left: 40px;">Four panel mounting clips shall be used</p> <p style="padding-left: 40px;">Minimum panel thickness shall be 2mm (0.08inches) Steel 3mm (0.12inches) Aluminium</p> <p style="padding-left: 40px;">Outside panel finish shall be smooth, free from particle inclusions, runs or build-up around cut-out.</p> <p style="padding-left: 40px;">Panel cut-out shall be 66.2 x 136.0mm -0.0 +0.5 (2.60 x 5.35 inches -0.00 +0.02)</p> <p style="padding-left: 40px;">Edges of panel cut-out shall be deburred and clean</p> <p style="padding-left: 40px;">Each panel mounting clip shall be tightened to between: 20 and 22cNm (1.77 to 1.95 inLb)</p>			Voc	equal to or less than	Vmax	La	equal to or greater than	Lcable + Li	Ca	equal to or greater than	Ccable + Ci					
Voc	equal to or less than	Vmax														
La	equal to or greater than	Lcable + Li														
Ca	equal to or greater than	Ccable + Ci														
Title FM Approvals Control Drawing for nonincendive BA454D & BA458C Batch Controller			Drawn	Checked	Scale											
			RC		NTS											
			Drawing No.		CI450-13											
			Sheet 2													

 <p>BEKA associates England Hitchin company confidential, copyright reserved.</p>	Iss.		Appd.							
	Date		Ckd.							
	Modification									
	Modification									
<p>6. When installed in a hazardous (classified) location the BA454D Batch Controller shall be fitted with cable glands / conduit hubs selected from the following table.</p> <p>Metallic glands and hubs must be grounded - see note 7.</p> <table border="1" style="width: 100%;"> <thead> <tr> <th style="width: 20%;">Class</th> <th>Permitted gland or conduit hub</th> </tr> </thead> <tbody> <tr> <td>Class I</td> <td>Any metallic or plastic cable gland or conduit hub that provides the required environmental protection.</td> </tr> <tr> <td>Class II and III</td> <td> <p>Crouse - Hinds Myler hubs SSTG-1 STG-1 STAG-1 MHUB-1</p> <p>O-Z / Gedfrey hub CHMG-50DT</p> <p>REMKE hub WH-1-G</p> <p>Killark Glands CMCXAA050 MCR050 MCX050</p> </td> </tr> </tbody> </table> <p>7. In addition to the supplied bonding plate, when 2 or 3 metallic glands or conduit hubs are fitted to a BA454D Batch Controller, all metallic glands or conduit hubs must be connected together and grounded.</p> <p>8. CAUTION: The BA454D and BA458C Batch Controller enclosures are manufactured from conductive plastic per Article 250 of the National Electrical Code the enclosures shall be grounded using the 'E' terminal on the terminal block.</p> <p>9. Input connections shall only be made to terminals 11 and 12 (INPUT 1), or to terminals 13, 14, 15, 16 and 17 (INPUT 2). These inputs shall not be used at the same time.</p>					Class	Permitted gland or conduit hub	Class I	Any metallic or plastic cable gland or conduit hub that provides the required environmental protection.	Class II and III	<p>Crouse - Hinds Myler hubs SSTG-1 STG-1 STAG-1 MHUB-1</p> <p>O-Z / Gedfrey hub CHMG-50DT</p> <p>REMKE hub WH-1-G</p> <p>Killark Glands CMCXAA050 MCR050 MCX050</p>
Class	Permitted gland or conduit hub									
Class I	Any metallic or plastic cable gland or conduit hub that provides the required environmental protection.									
Class II and III	<p>Crouse - Hinds Myler hubs SSTG-1 STG-1 STAG-1 MHUB-1</p> <p>O-Z / Gedfrey hub CHMG-50DT</p> <p>REMKE hub WH-1-G</p> <p>Killark Glands CMCXAA050 MCR050 MCX050</p>									
Date	04 2008	Title		Drawn						
Iss.	1	FM Approvals Control Drawing for nonincendive BA454D & BA458C Batch Controller		RC						
				Checked						
				Scale						
				NTS						
				Drawing No.						
				Sheet 3						
				CI450-13						