

Actuator LA12

Thanks to its small size and outstanding performance, the actuator LA12 provides a practical and cost-effective alternative to small-scale traditional hydraulic and pneumatic systems. The LA12 is ideal for applications requiring short linear movements. After many years on the market, the actuator LA12 demonstrated that it is a very reliable and robust actuator that can handle almost any situation and challenge.



IC INTEGRATED CONTROLLER

Features:

- 12 or 24 V DC permanent magnetic motor
- Max. thrust 750 N
- Max. speed up to 40 mm/sec. depending on load and spindle pitch
- Stroke length from 19 to 130mm
- Compact design, built-in dimensions 245 mm (up to 355 mm)
- Piston rod and back fixture in high-strength plastic
- Protection class: IPX1
- Built-in endstop switches

Options in general:

- Stainless steel inner tubes, piston rod eyes and back fixtures
- Protection class: IP66
- Reed switch
- IC options including:
 - IC - Integrated Controller
 - Hall sensor
 - Analogue or digital feedback for precise positioning
 - Mechanical potentiometer (max. 100 mm stroke length)
 - Endstop signals
 - Ready signal for diagnostics

Usage:

- Duty cycle at 750N and 2 mm pitch is max. 10%
- Duty cycle at 300N and 4 mm pitch is max. 40%
- Duty cycle at 200N and 6 mm pitch is max. 60%
- The duty cycles are valid for operation within an ambient temperature of +5°C to +40°C
- Ambient operating temperature: -20° to +60°C, full performance from +5°C to +40°C

Chapter 1

Specifications 3
Technical specifications..... 4
Stroke and built-in tolerances 4
LA12 Dimensions 5
LA12 Back fixture orientation 5
Cable dimensions 5
Speed and current curves..... 6-7

Chapter 2

I/O specifications:

Actuator without feedback 8
Actuator with:
Absolute positioning - Mechanical potentiometer feedback 9
Absolute positioning - Analogue feedback 10
Reed - Relative positioning 4 wires 11
Reed - Relative positioning 3 wires 12
IC (no EOS out)..... 13
IC and endstop signals 14

Chapter 3

Environmental tests - Climatic 15
Environmental tests - Mechanical 15
Environmental tests - Electrical 16

Chapter 1

Specifications

Motor:	Permanent magnet motor 12 or 24V *
Housing:	High-strength plastic housing
Spindle part:	Acme spindle: Trapezoidal spindle with high efficiency
Temperature range:	- 20° C to +60° C - 4° F to +140° F Full performance +5° C to +40° C
Storage temperature:	-40°C to +105°C
Weather protection:	Rated IPX1, or if chosen IP66
Noise level:	55-57dB (A), measuring method DS/EN ISO 3743-1 actuator not loaded
Compatibility:	The LA12 IC is compatible with SMPS-T160 (For combination possibilities, please see the User Manual for SMPS-T160)

Be aware of the following two symbols throughout this product data sheet:



Recommendations

Failing to follow these instructions can result in the actuator suffering damage or being ruined.



Additional information

Usage tips or additional information that is important in connection with the use of the actuator.

Technical specifications

Type	Motor voltage (V)	Spindle Pitch (mm)	Thrust max. Push/Pull (N)	Self-lock max. (Push) (N)	Self-lock max. (Pull) (N)	*Typical speed (mm/s)		Stroke length (in steps of 30 mm)			*Typical Amp. (A)	
						No load	Full load	Min.		Max.	No load	Full load
12XX00-1XXX12XX	12	2	750	750	375	14	5	40	-	130	1.75	4.6
12XX00-1XXX24XX	24	2	750	750	375	14	6	40	-	130	0.75	2.2
12XX00-2XXX12XX	12	4	300	300	150	27	16	40	-	130	1.75	2.5
12XX00-2XXX24XX	24	4	300	300	150	27	16	40	-	130	0.75	1.5
12XX00-3XXX12XX	12	6	200	200	100	40	28	40	-	130	1.75	2.2
12XX00-3XXX24XX	24	6	200	200	100	40	28	40	-	130	0.75	1.0

* The typical values can have a variation of $\pm 20\%$ on the current values and $\pm 10\%$ on the speed values. Measurements are made with an actuator in connection with a stable power supply and an ambient temperature at 20°C.



• Self locking ability

To ensure maximum self-locking ability, please be sure that the motor is shorted when stopped. Actuators with integrated controller provide this feature, as long as the actuator is powered.

- When using soft stop on a DC-motor, a short peak of higher voltage will be sent back towards the power supply. It is important when selecting the power supply that it does not turn off the output, when this backwards load dump occurs.

Stroke and built-in tolerances

Platform options	Descriptions	Stroke tolerance	Example for 100 mm stroke	BID tolerance	Example for 245 mm BID
12XXXXXXXXXXXXXX	All variants	+2/-2 mm	98 to 102 mm	+2/-2 mm	243 to 247 mm

LA12 Dimensions

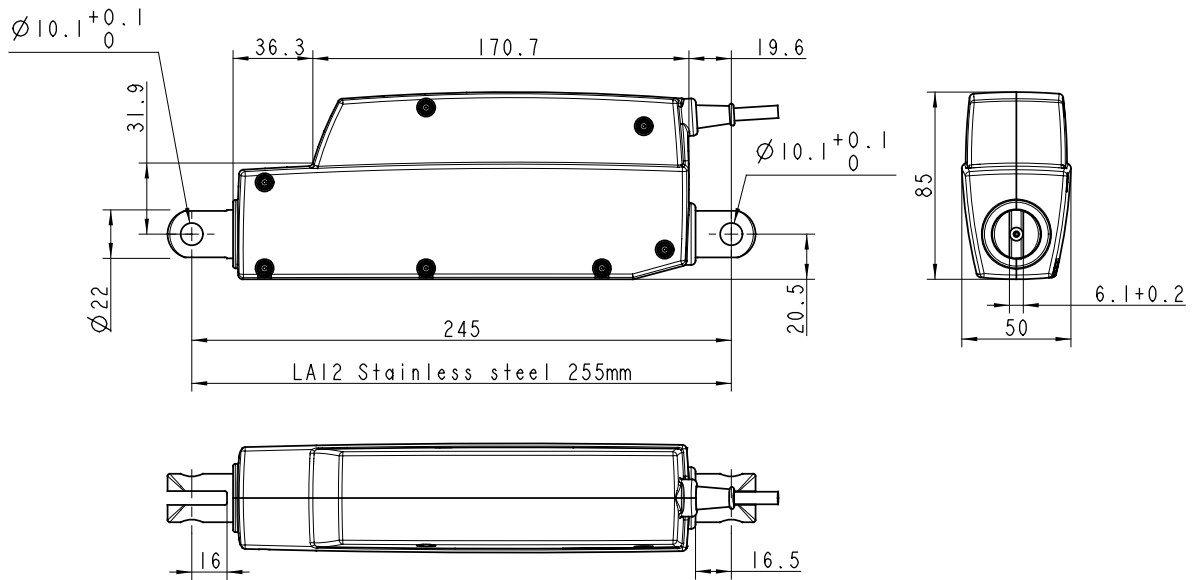

LA12 Back fixture orientation

Option 1 = 0°



Option 2 = 90°



The Piston Rod Eye is only allowed to turn 0 - 90 degrees.

Cable dimensions

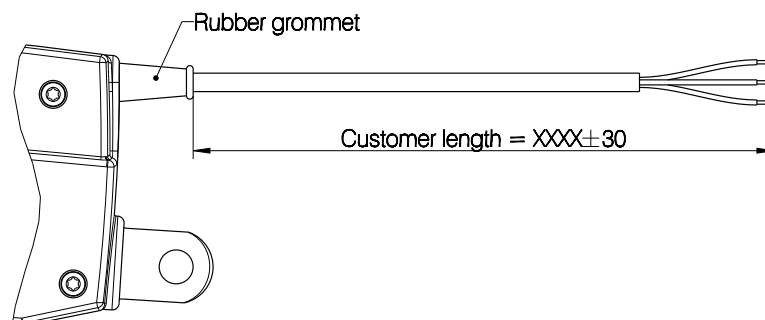

Speed and current curves - 12V motor:

The below values are typical values made with a stable power supply and an ambient temperature of 20° C.

LA12 -12V Speed v's Thrust

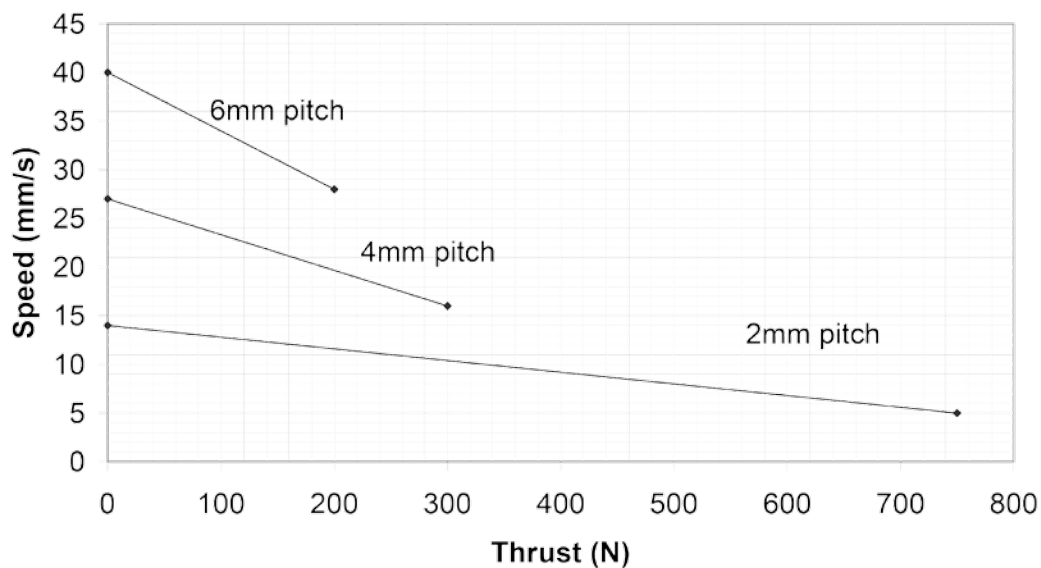

LA12 - 12V Current v's Thrust

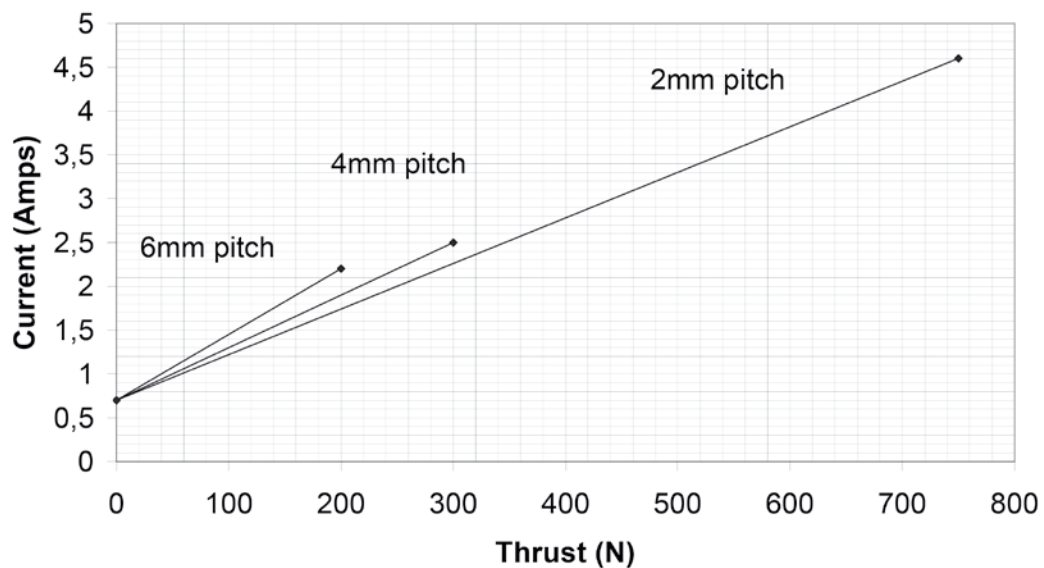

Speed and current curves - 24V motor:

The below values are typical values made with a stable power supply and an ambient temperature of 20° C.

24V Speed v's thrust

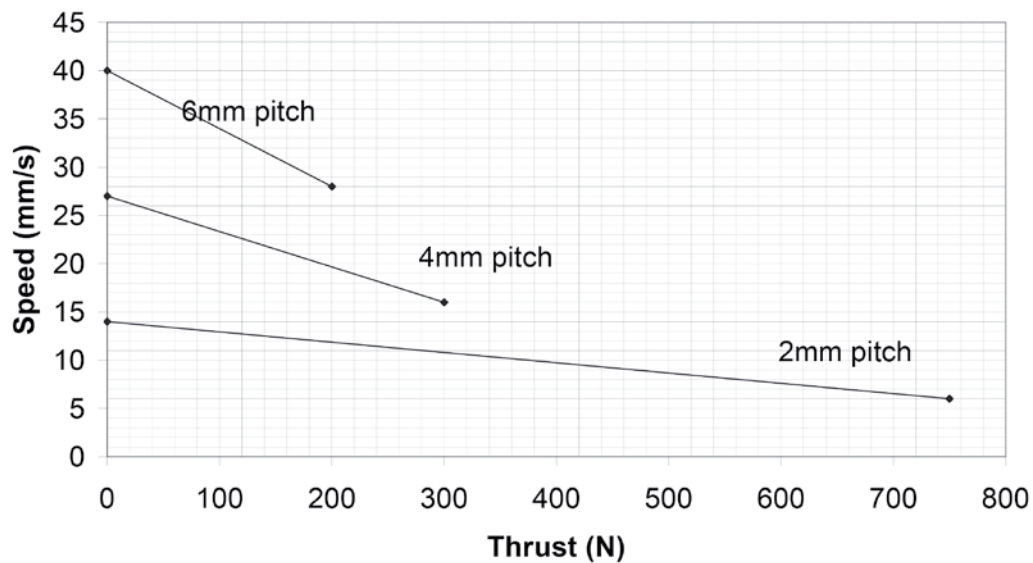

24V Current v's Thrust

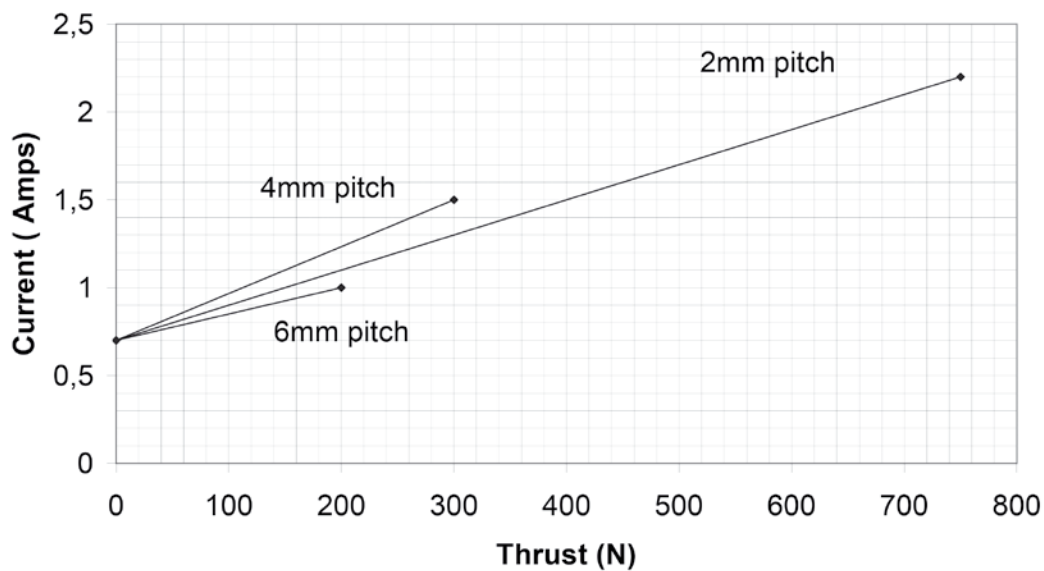

Chapter 2

I/O specifications: Actuator without feedback

Input/Output	Specification	Comments
Description	Permanent magnetic DC motor.	
Brown	12-24VDC (+/-) 12V \pm 20% 24V \pm 10%	To extend actuator: Connect Brown to positive To retract actuator: Connect Brown to negative
Blue	Under normal conditions: 12V, max. 5A depending on load 24V, max. 2.5A depending on load	To extend actuator: Connect Blue to negative To retract actuator: Connect Blue to positive

I/O specifications: Actuator with absolute positioning - Mechanical potentiometer feedback

Input/Output	Specification	Comments
Description	The actuator can be equipped with a mechanical potentiometer that gives an analogue feedback signal when the actuator moves.	
Red	12-24VDC (+/-) 12V ± 20% 24V ± 10%	To extend actuator: Connect Red to positive To retract actuator: Connect Red to negative
Blue	Under normal conditions: 12V, max. 5A depending on load 24V, max. 2.5A depending on load	To extend actuator: Connect Blue to negative To retract actuator: Connect Blue to positive
Green	Signal power supply (+)	+10V or other value
Black	Signal power supply GND (-)	
Yellow	Potentiometer feedback Slide potentiometer, 10 kohm 1 kohm = 0 mm stroke 11 kohm = 100 mm stroke The maximum effect: 0.1W	Linearity: ± 20% Minimum lifetime: 15,000 cycles Average lifetime: 40,000 cycles Max. current output: 1mA

I/O specifications: Actuator with absolute positioning - Analogue feedback

Input/Output	Specification	Comments
Description	The actuator can be equipped with electronic circuit that gives an analogue feedback signal when the actuator moves.	
Red	12-24VDC (+/-) 12V ± 20% 24V ± 10%	To extend actuator: Connect Red to negative To retract actuator: Connect Red to positive
Blue	Under normal conditions: 12V, max. 5A depending on load 24V, max. 2.5A depending on load	To extend actuator: Connect Blue to positive To retract actuator: Connect Blue to negative
Green	Signal power supply (+) 12-24VDC	Current consumption: Max. 60mA, also when the actuator is not running
Black	Signal power supply GND (-)	
Yellow	Analogue feedback 0-10V (Option B) 0.5-4.5V (Option C)	Tolerances +/- 0.2V Max. current output: 1mA Ripple max. 200mV Transaction delay 100ms Linear feedback 0.5% It is recommendable to have the actuator to activate its limit switches on a regular basis, to ensure more precise positioning

I/O specifications: Actuator with Reed - Relative positioning 4 wires

Input/Output	Specification	Comments
Description	The actuator can be equipped with a Reed sensor and a spindle magnet that give a relative positioning feedback signal when the actuator moves. The output signal is a PNP signal.	
Red	12-24VDC (+/-) 12V ± 20%	To extend actuator: Connect Red to positive To retract actuator: Connect Red to negative
Blue	24V ± 10%	To extend actuator: Connect Blue to negative To retract actuator: Connect Blue to positive
Black	Reed output: same as input voltage 4 pole magnet (Option M) 2mm pitch = 0.5mm per pulse 4mm pitch = 1.0mm per pulse 6mm pitch = 1.5mm per pulse 10 pole magnet (Option E) 2mm pitch = 0.2mm per pulse 4mm pitch = 0.4mm per pulse 6mm pitch = 0.6mm per pulse	Max. switching capacity 750mA
White	Signal power supply (+)	

I/O specifications: Actuator with Reed - Relative positioning 3 wires

Input/Output	Specification	Comments
Description	The actuator can be equipped with a Reed sensor and a spindle magnet that give a relative positioning feedback signal when the actuator moves. The output signal is a PNP signal.	
Brown	12-24VDC (+/-) 12V ± 20%	To extend actuator: Connect Brown to positive To retract actuator: Connect Brown to negative
Black	24V ± 10%	To extend actuator: Connect Black to negative To retract actuator: Connect Black to positive
Blue	Reed output: same as input voltage -1V 4 pole magnet (Option R) 2mm pitch - 0.5mm per pulse 4mm pitch = 1.0mm per pulse 6mm pitch = 1.5mm per pulse	Max. switching capacity 750mA

I/O specifications: Actuator with IC (no EOS out)

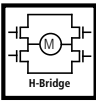
Input/Output	Specification	Comments
Description	<p>Easy to use interface with integrated power electronics (H-bridge).</p> <p>The actuator can also be equipped with electronic circuit that gives an absolute or relative feedback signal.</p> <p>The version with "IC option" cannot be operated with PWM (power supply).</p>	
Brown	<p>12-24VDC Connect Brown to positive (VDC)</p> <p>12V ± 20% 24V ± 10%</p> <p>Under normal conditions: 12V, max. 5A depending on load 24V, max. 2.5A depending on load</p>	<p>Note: Do not change the power supply polarity on the brown and blue wires!</p> <p>Power supply GND (-) is electrically connected to the housing</p>
Blue	<p>12-24VDC Connect Blue to negative (GND)</p> <p>12V ± 20% 24V ± 10%</p> <p>Under normal conditions: 12V, max. 5A depending on load 24V, max. 2.5A depending on load</p>	<p>If the temperature drops below 0°C, all current limits will automatically increase to 11A</p>
Red	Extends the actuator	<p>On/off voltages: > 67% of V_{IN} = ON < 33% of V_{IN} = OFF</p> <p>Input current: 10mA</p>
Black	Retracts the actuator	
Green	Not to be connected	
Yellow	Not to be connected	
Violet	Not to be connected	
White	Not to be connected	

I/O specifications: Actuator with IC and endstop signals

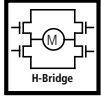
Input/Output	Specification	Comments
Description	<p>Easy to use interface with integrated power electronics (H-bridge).</p> <p>The actuator can also be equipped with electronic circuit that gives an absolute or relative feedback signal.</p> <p>The version with "IC option" cannot be operated with PWM (power supply).</p>	
Brown	<p>12-24VDC Connect Brown to positive (VDC)</p> <p>12V ± 20% 24V ± 10%</p> <p>Under normal conditions: 12V, max. 5A depending on load 24V, max. 2.5A depending on load</p>	<p>Note: Do not change the power supply polarity on the brown and blue wires!</p> <p>Power supply GND (-) is electrically connected to the housing</p> <p>If the temperature drops below 0°C, all current limits will automatically increase to 11A</p>
Blue	<p>12-24VDC Connect Blue to negative (GND)</p> <p>12V ± 20% 24V ± 10%</p> <p>Under normal conditions: 12V, max. 5A depending on load 24V, max. 2.5A depending on load</p>	
Red	Extends the actuator	<p>On/off voltages:</p> <p>> 67% of V_{IN} = ON < 33% of V_{IN} = OFF</p> <p>Input current: 10mA</p>
Black	Retracts the actuator	
Green	Endstop signal out	<p>Output voltage min. $V_{IN} - 1V$ Source current max. 100mA</p>
Yellow	Endstop signal in	Endstop signals are NOT potential free
Violet	<p>Mechanical slide potentiometer 0-10V (Option T)</p> <p>Slide potentiometer, 10 kohm 1 kohm = 0 mm stroke 11 kohm = 100 mm stroke</p> <p>The maximum effect: 0.1W</p>	<p>Max. 100mm stroke Linearity: ± 20%</p> <p>Minimum lifetime: 15,000 cycles Average lifetime: 40,000 cycles</p> <p>Max. current output: 1mA</p>
	<p>Analogue feedback 0-10V (Option F) 0.5-4.5V (Option K)</p>	<p>Tolerances +/- 0.2V Max. current output 1mA Ripple max. 200mV Transaction delay 100ms Linear feedback 0.5%</p>
	<p>Hall sensor 2 pulses (Option L) 4 pulses (Option N)</p>	<p>Max. current output 12mA Output = input -1V</p>
	<p>Single Hall (Option S)</p>	<p>Max. current output 12mA Output = input -1V Min. on time 2.5ms</p>
White	Signal GND	<p>Only for mechanical slide potentiometer and analogue feedback Max. 1mA</p>
	Ready signal	<p>Only for single hall and PWM Max. 10mA</p>

Environmental tests - Climatic

Test	Specification	Comment
Degrees of protection	EN60529 – IP6x	IP6X - Dust: Dust-tight, No ingress of dust. Actuator is not activated.
	EN60529 – IPx6	IPX6 - Water: Ingress of water in quantities causing harmful effects is not allowed. Duration: 100 litres pr. minute in 3 minutes. Actuator is not activated.
	EN60529 – IPx6 - dynamic	IPX6 - Connected actuator: Actuator is driving out and in for 3 min. 100 (l/min) jet of water is placed at the wiper ring for 3 (min).
Salt mist.	EN60068-2-52 (Kb)	Dynamic salt spray test Salt solution: 5% sodium chloride (NaCl) 4 spraying periods, each of 2 hours. Humidity storage 20 days after each. Actuator is power up connected during the test. Exposure time: 10.000 cycles

Environmental tests - Mechanical

Test	Specification	Comment
Low Temperature Soak		Unit powered and operating for 96Hrs @ -40°C
High Temperature Soak		Unit powered and operating for 96Hrs @ 105°C
Mechanical Shock (Handling) - Drop Test	BS2011 Part 2.1 Eb.	400mm drop onto Hardwood bench minimum 40 mm thick. Onto all practical edges and faces
Mechanical Shock (Operational)		100 off 400m/sec ² 6 ms shock pulses - in 3 axes
Vibration (Random)		24 hours in each ax. Breakpoint Freq. 10Hz @ 0.005 g ² /Hz, 150Hz @ 0.060 g ² /Hz, 220Hz @ 0.080 g ² /Hz 350Hz @ 0.040 g ² /Hz
Vibration (Resonant Search)		10 Hz - 2 KHz @ 4G, Rate = 1octave/min
Bump		40G in 6 mS x 100 in each direction pr. axis

Environmental tests - Electrical

Standard	Specification	FOCUS ON
EN/IEC 60204-1: 2006 +A1: 2009	Safety of machinery - Electrical equipment of machines - Part 1: General requirements	<ul style="list-style-type: none"> INDUSTRIAL AUTOMATION
EN/IEC 60204-32: 2008	Safety of machinery - Electrical equipment of machines - Part 32: Requirements for hoisting machines	<ul style="list-style-type: none"> INDUSTRIAL AUTOMATION PLATFORMS AND LIFTS
EN/IEC 61000-6-1: 2007	Electromagnetic compatibility (EMC) - Part 6-1: Generic standards - Immunity for residential, commercial and light- industrial environments	<ul style="list-style-type: none"> INDUSTRIAL AUTOMATION
EN/IEC 61000-6-2: 2005	Electromagnetic compatibility (EMC) - Part 6-2: Generic standards - Immunity for industrial environments	<ul style="list-style-type: none"> INDUSTRIAL AUTOMATION
EN/IEC 61000-6-3: 2007 + A1:2011	Electromagnetic compatibility (EMC) - Part 6-3: Generic standards - Emission standard for residential, commercial and light-industrial environments	<ul style="list-style-type: none"> INDUSTRIAL AUTOMATION
EN/IEC 61000-6-4: 2007 + A1:2011	Electromagnetic compatibility (EMC) - Part 6: Generic standards - Section 4: Emission standard for industrial environments	<ul style="list-style-type: none"> INDUSTRIAL AUTOMATION



All electrical tests are conducted and radiated emission (EMC) tests.