

Product range



siegling transilon
conveyor and processing belts

Siegling Transilon for light materials handling ...

Under the Siegling Transilon brand name, Forbo Siegling has developed a product line of 600 different designs worldwide that consistently reflects market requirements. Many of the types are based on joint development with users and OEMs.

From rugged "jacks-of-all-trades" to high-tech "specialists": the Siegling Transilon product line offers a wide range of types for the most varied of conveying tasks in all industries, while at the same time also carrying out processing tasks. Special literature is available for many of the topics and industries mentioned in this brochure.

The conditions under which conveyor and power transmission belts are used are seldom identical. So when using Siegling Transilon, take advantage of the experience and competence of your Forbo Siegling consultant.

... for example in the food industry



Siegling Transilon is used for the conveying of packaged and unpackaged food. Frequent cleaning with hot water and low operating temperatures are typical conditions for these applications.

... for example in distribution and logistics centres



In complex distribution systems with automated sorters, Siegling Transilon ensures smooth operation of all conveying tasks.

... for example for sports and leisure activities



Treadmill belts must be resistant to extreme punctual loads but at the same time track perfectly straight. Siegling Transilon passes the fitness test.

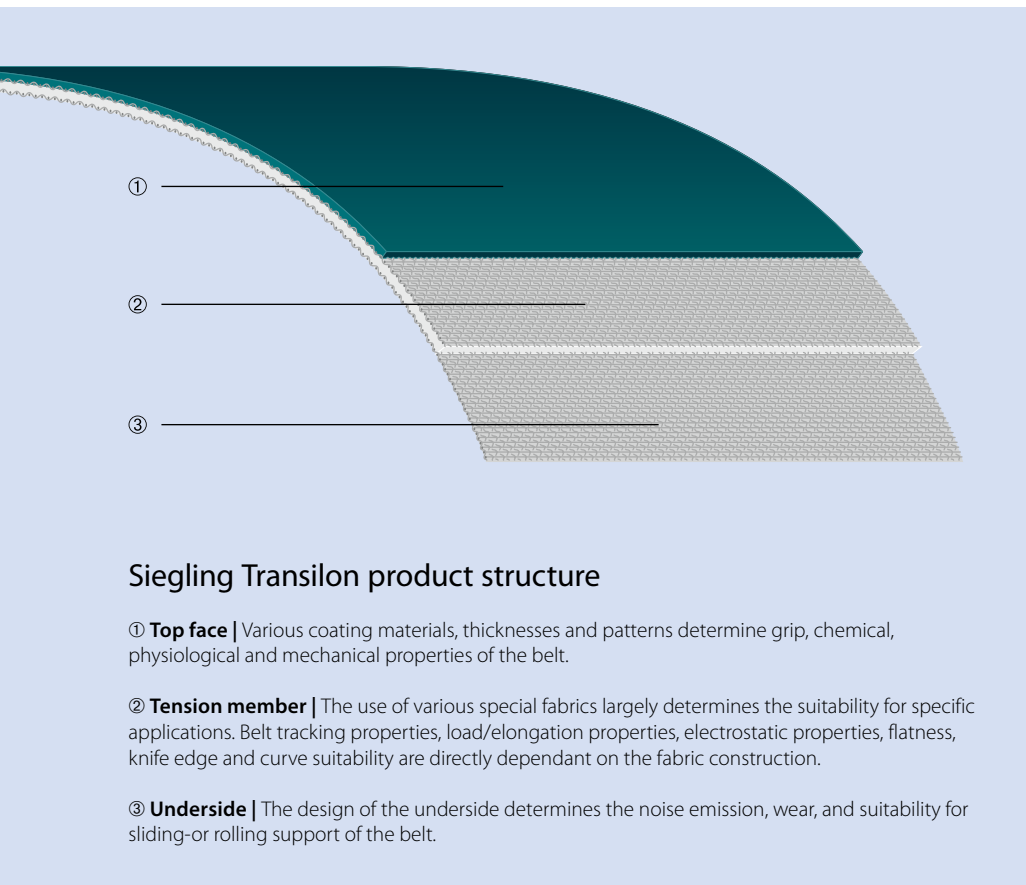

Siegling Transilon product structure

① **Top face** | Various coating materials, thicknesses and patterns determine grip, chemical, physiological and mechanical properties of the belt.

② **Tension member** | The use of various special fabrics largely determines the suitability for specific applications. Belt tracking properties, load/elongation properties, electrostatic properties, flatness, knife edge and curve suitability are directly dependant on the fabric construction.

③ **Underside** | The design of the underside determines the noise emission, wear, and suitability for sliding-or rolling support of the belt.

Contents

Siegling Transilon for light materials handling ...

... in all industries 2

... for the most varied
of conveying and
processing tasks 4

Special processing 7

Special features,
properties and
patterns 8

Types of splices 10

Splicing equipment 11

Available as 11

Product ranges 12

The properties

The advantages

virtually stretchless	▶	small take-up ranges, economical
longitudinally flexible	▶	small drum diameters, energy-saving
dimensionally stable	▶	maintenance-free, reliable operation
low-noise	▶	humane working conditions
long product life	▶	economical
light and thin	▶	easy to handle, cost-saving design



MOVEMENT SYSTEMS

... for the most varied of conveying and processing tasks

Horizontal conveying

Even a conveying task which seems quite simple can require a whole host of belt properties. Forbo Siegling has the best belt type for various goods, conveying speeds, reversing systems, stop & go and accumulation conveying, and other operating conditions. Some examples of the diverse features of Siegling Transilon include:

- troughable to particularly laterally stiff types
- exceptionally low-noise to flame-retardant
- pyrolysis-resistant to suitability for conveying unpackaged food
- non-antistatic to highly conductive and ATEX-approved
- surfaces suitable for accumulation conveying and especially good grip.

Horizontal conveying with troughable belts. The tension member construction provides the flexibility in the desired direction.



Collecting belt in check-in area of an airport. The flatness of the belt type here ensures that the goods can be discharged to the side smoothly, even on wide belts. Flame-retardance is a "must" in modern airports.

Belts for telescopic conveyors – here being used to unload lorries – must be designed to run with counter bending and at the same time, to withstand high punctual loads.

Inclined conveying

Goods can be conveyed at an incline even on smooth belt surfaces. The conveying angle is dependent on a variety of factors such as the type of goods being conveyed, the top face coating and external factors like dust, moisture, etc.

For large conveying angles and for the conveying of small pieces and bulk goods, Forbo Siegling offers patterned belts or belts equipped with lateral profiles.

Curved conveying

Curved belts from Forbo Siegling are suitable for use in conjunction with a diverse array of belt tracking systems and are in use on the conveyors of numerous major manufacturers.

Thanks to largely-automated fabrication, we guarantee strict adherence to the geometrical shapes and dimensions required when supplying finished belts.

Dividing curves into several segments makes for a favourable distribution of force vectors in the belt so even heavy goods can be carried without any problems.



Inclined conveying in the tobacco industry. In this area, conveying angles of up to 22° are possible for belt types with smooth surfaces.



Spiral curve in the confectionery industry.



Curved conveyor in a distribution centre.

Collection and distribution

When pushers and ploughs are used, the belt's laterally stiff design guarantees that it will lie flat and continue to run in a straight line reliably. The lateral loading and discharge of goods is achieved by using very smooth, wear-resistant surfaces. Lateral sorters (e.g. carrier cells), on the other hand, require very thin, flexible belts whose surfaces have high coefficients of friction. Their special tension member construction means that they have very low energy consumption.

Processing belts

With Siegling Transilon, the gap is often bridged between the classical conveying function from "A" to "B" and an active function in the production process.

For example, in the textile industry our processing belts stack thin layers of web, in large bakeries they form balls of dough, in the wood industry they compress chip mat in the pre-press, in dairies milk is coagulated on the belts to form cheese. Here are just a few examples of process operations.



Lateral sorter in a distribution centre. The high acceleration requires the belt surface to have an extremely high coefficient of friction.



Pre-press belt in the manufacture of particle boards. The particle mat is pre-pressed while being conveyed.



Cross-lapping of web layers in the nonwoven industry. High production speed and acceleration of masses while the web is guided directly between the belts places extremely high demands on the processing belts.

In large bakeries balls of dough are formed as a result of differing belt speeds.



Special processing

Numerous combinations of tension member-design and coating design are possible. But certain conveying and processing tasks require more: mechanical, physical or chemical belt properties which can be provided only by special production processes, combinations of materials and/or finishing (see next pages).

Brochures 317 and 318 provide information about storing, finishing and fitting, as well as special features and properties. Further information on request.



Profiles/Sidewalls

Conveyor belts with profiles are used for the inclined and declined conveying of bulk goods and small pieces. Profiles are available in various shapes and sizes and can in some cases be supplied as roll material. To contain goods on the sides when conveying bulk goods, sidewall profiles are used – often in conjunction with lateral profiles.

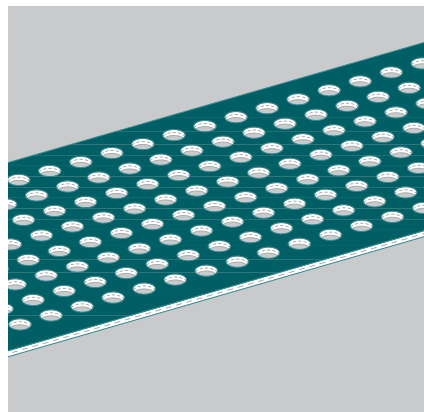

Perforations

It is possible to maintain very narrow tolerances for practically any pattern of perforations in Siegling Transilon material. (Belt material with perforations can not be used for form-fit transmission of power.)



Belt edge sealing

Belt edge sealing prevents oil, grease, water, foreign bodies and bacteria from penetrating the belt. At the same time, it increases the service life of the conveyor belt.

This additional predection can be applied to virtually every Siegling Transilon conveyor belt.



Special features, properties and patterns

Patterns

Forbo Siegling has developed and optimised a wide range of surface patterns for very different applications. The appropriately optimised surface patterns ensure for example, ideal grip with demanding goods such as roller suitcases and good release properties with dough and are also used to emboss manufacturer-specific patterns on the underside of chocolate.

Siegling Transilon patterned belts can run at incline angles of up to 30° without profiles. For larger incline angles they can also be fitted with profiles and sidewalls (see previous pages).

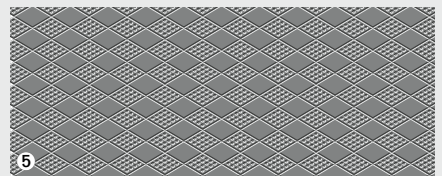
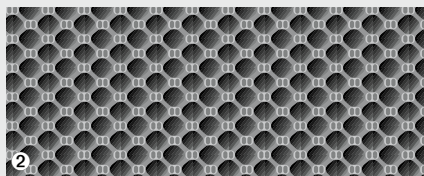
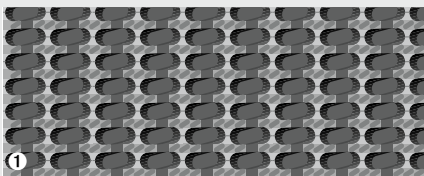
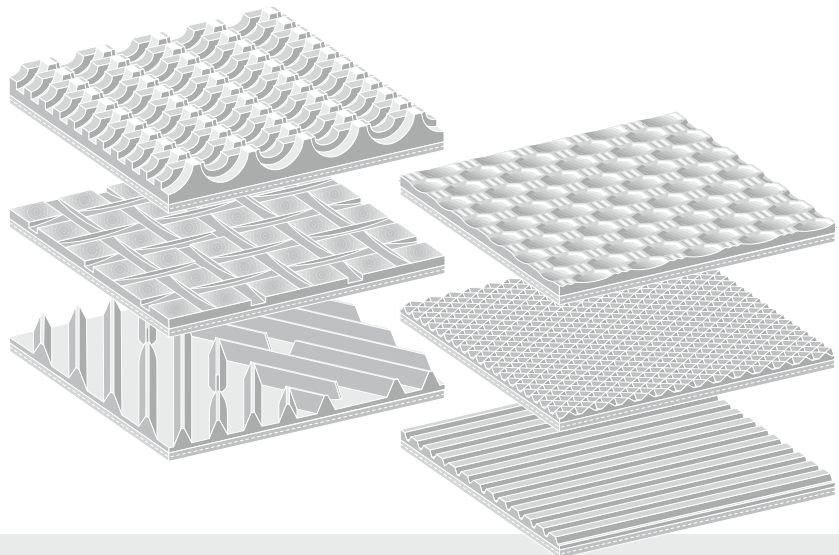

- ① **AR** anti-skid pattern (M 1:1)
- ② **GSTR** coarse textured pattern (M 1:1)
- ③ **STR** normal textured pattern (M 1:1)
- ④ **LG** longitudinal groove (M 1:1)
- ⑤ **RFF** fine rhomboid pattern (M 1:1)
- ⑥ **NP** inverted pyramid pattern (M 1:1)
- ⑦ **SG** lattice pattern (M 1:1)

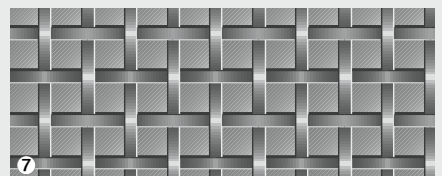
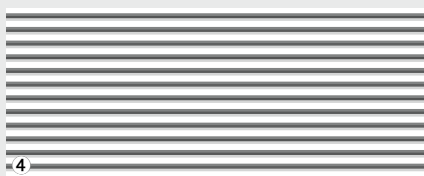
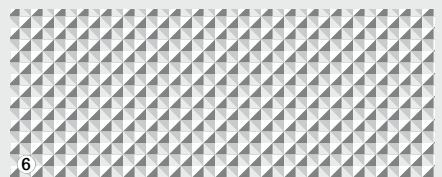
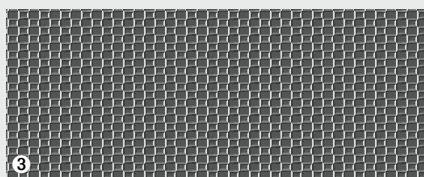



Electrical properties

In numerous conveying and processing functions, the electrical properties of the belt material are important for smooth operation. As a standard, Siegling Transilon belts are equipped with a conductive tension member which prevents electrostatic build-up in the belt. Siegling Transilon non-antistatic belts (NA) are not electrically conductive. They facilitate special engineering solutions for production conveyors where high frequencies are used or regulation is carried out electro-magnetically e.g. in security screening and in quality control. Siegling Transilon highly conductive belts (HC) can also divert electro-static build-up in the goods conveyed because of their highly conductive coating and/or the tension member. For the safe conveying of electrical components and other electronically sensitive goods.

Food safety

Thanks to numerous product innovations, Forbo Siegling contributes significantly to the hygienic conditions in the sensitive production areas of the food industry. This supports you in implementing your HACCP concept. And users and end users know food has been produced safely.

FDA/EU

All materials used in our food types comply with the FDA 21 CFR, (EU) 10/2011 and (EC) 1935/2004 regulations on the materials used and migration thresholds.

Halal

In the food segment, the majority of the Siegling Transilon PU- and PVC-types are certified as complying with Halal regulations by IFRC Asia (a member of the World Halal Council).

Further special products

In addition to these patterns and features of conveyor and processing belts, Forbo Siegling offer numerous special developments for various applications including:

- belts resistant to UV
- belts with silicone coatings
- flame-retardant belts
- belts for hot goods
- silent belts
- wear-resistant belts
- knife edge belts
- troughable belts
- ATEX-compliant belts

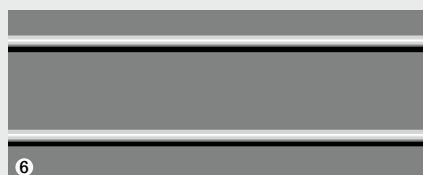
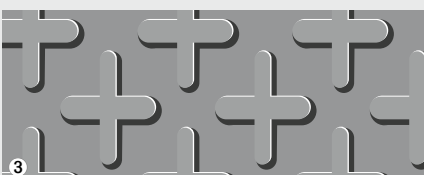
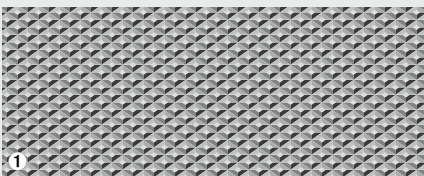

- ① **RF** fine rhomboid pattern (M 1:1)
- ② **VN** vertical stud pattern (M 1:2)
- ③ **KN** cross-stud pattern (M 1:1)
- ④ **R80** rhomboid pattern (M 1:2)
- ⑤ **FG** herringbone pattern (M 1:2)
- ⑥ **RPH** high round profile pattern (M 1:2)
- ⑦ **CH** check-in pattern (M 1:4)

Types of splices

The splicing method appropriate for individual applications is dependent on the belt types used and the prevailing operating conditions. In addition to splice reliability, flexibility of the splice and the effort required for fabrication are decisive criteria for the selection of the splicing method. Detailed instructions for all splicing procedures are available on request.

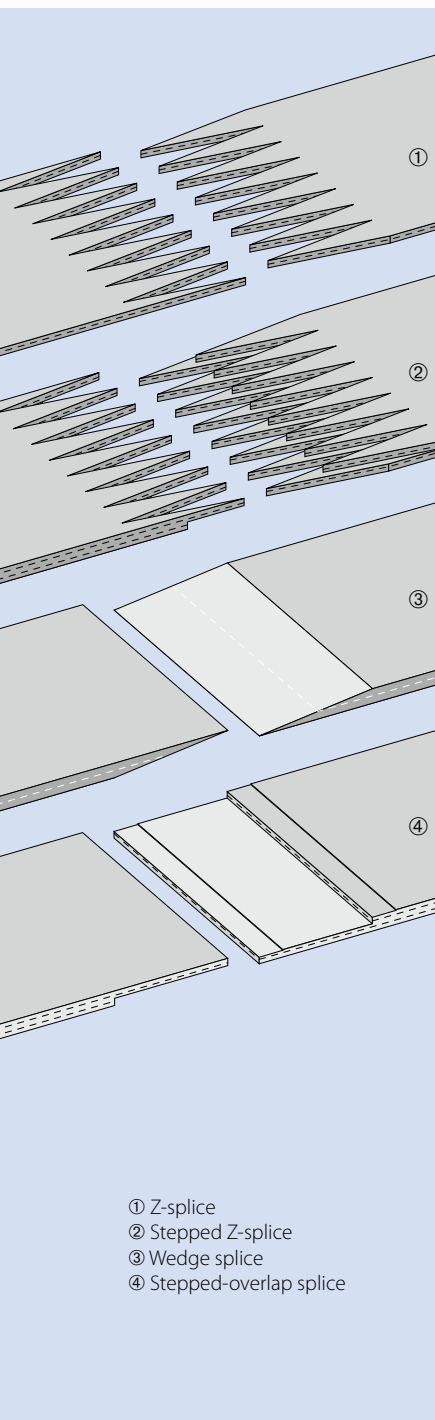

Hot-pressing

A hot-pressed splice provides the highest durability and flexibility. Following types are available:

■ Z-splice

Meets the most rigorous of requirements for uniformity of thickness. Very flexible splice, required particularly for knife edge belts. Standard splice for 1 and 2-ply belt-types.

■ Stepped Z-splice

Properties comparable to those of the Z-splice. Also suitable for rugged operating conditions (e.g. soiled drums). Possible for various 2 and 3-ply belt types.

■ Wedge splice

Splice type for solid-woven fabric and NOVO types.

■ Stepped overlap splice

Especially for 2 and 3-ply belt types with duroplastic coatings.

Cold-pressing

It is possible to cold-press wedge or stepped overlap splices in independent fitting repair jobs on site. Please note that such splices have limited strength and flexibility.

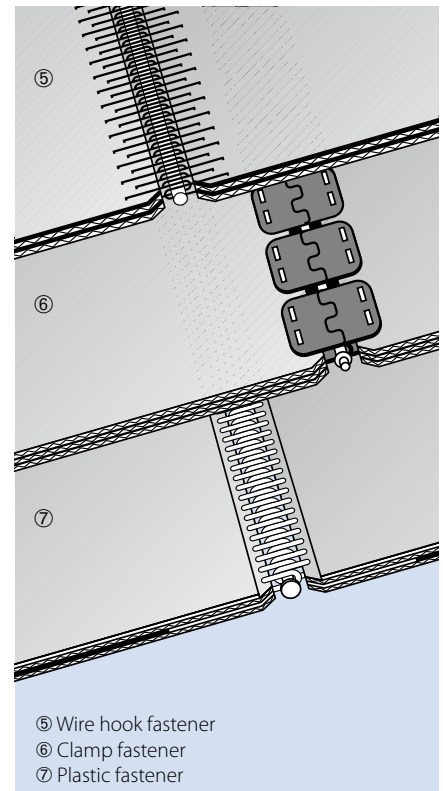

Mechanical fasteners

Mechanical fasteners make it possible to

- quickly fit and remove the belt without disassembling machine components,
- repair a belt at short notice by inserting a piece of belt material,
- make belts endless quickly and easily (please inquire about lacers).

Following fasteners are available:

■ Wire hook fasteners (HS)

■ Clamp fasteners (CS)

■ Plastic fasteners (KS), also available optionally imbedded or heated into the belt coating.



Splicing Equipment

For reliable hot-pressing (splicing) of Siegling Transilon conveyor and processing belts, a diverse, tried-and-tested range of equipment is available.

The equipment required for splicing depends mainly on the type of splice. Other important factors include the conditions under which the splice is to be fabricated (workshop or on-site fitting) and the width of the belts to be spliced.

The equipment depicted here is just a sample of our splicing equipment range. On request we will send you our complete equipment overview containing all important technical data for the equipment.

Siegling Transilon is available as

- endless belts
- belts prepared for hot or cold-pressing on site
- roll material for independent belt fabrication
- belts with mechanical fasteners
- belts with sealed edges (Proseal, Smartseal)
- belts with profiles welded on (longitudinal, lateral, diagonal, half-round)
- belts with sidewalls
- belts with perforations
- special designs with metal eyelets, impulse foils, special markings, etc.



MOVEMENT SYSTEMS

Standard product range

Technical data, properties and recommendations, possible applications	Article number	Total thickness approx. [mm]	Weight approx. [kg/m ²]	Effective pull at 1% elongation (k _{1%} relaxed) [N/mm width]*	d _{min} approx. [mm]**	Permissible operating temperature [°C]	Hardness of the top face coating as per DIN 53505 [Shore A]	Standard width supplied/ max. width supplied [mm]
A – Polyolefin								
E 2/1 A2/A2 NA-TT beige	900361	0.75	0.7	2.5	30 ¹⁾	-10/+60	90	3000
E 2/1 A2/A2 TT blue	906647	0.75	0.7	2	30 ¹⁾	-10/+60	90	3000/4300 ⁴⁾
E 4/2 A0/A2 MT-HACCP white FDA	906660	1.3	1.15	5	60 ⁸⁾ /r5	-10/+60	92	3000 ³⁾
E 8/2 0/A4 MT-TT transparent	906773	2.2	2	6	60	-10/+60	90	3000 ³⁾
E 9/2 A5/A5 NP/GL-TT transparent	900346	3.5	3	9	90	-10/+60	90	3100 ³⁾
E 9/2 A0/A15 VN-TT transparent	900344	4.8	3.3	7	90	-10/+60	86	1450 ³⁾
E 10/2 E0/A4 TT transparent	906652	2.25	2	8	60	-10/+60	90	4350 ³⁾
E 10/2 E0/A5 TT transparent	906505	2.6	2.4	7.5	60	-10/+60	90	4250 ³⁾
E 12/2 A0/A3 MT-TT green	900347	1.8	1.8	11.5	60	-10/+80	95	3100 ³⁾
E 12/2 A0/A3 MT-TT transparent	906583	1.8	1.8	11.5	60	-10/+80	95	3100 ³⁾
C/0 – Cotton/fabric, uncoated								
E 2/2 0/V/0 white FDA	906570	1.5	1.7	2	40 ⁸⁾ /r3	-10/+70		1500 ³⁾
E 2/2 U0/U/0 transparent FDA	906735	1.1	1.2	3.5	40 ⁸⁾ /r3	-30/+100		3000
E 3/2 U0/U/C FINE white	999638	1.4	1.4	2.5	40 ⁸⁾ /r3	-10/+100		1350
E 3/2 U0/U/C ROUGH blue	906729	2	1.7	2.5	40 ⁸⁾ /r3	-30/+100		2900
E 3/2 U0/U/C ROUGH transparent	906667	2	1.7	2.5	40 ⁸⁾ /r3	-30/+100		3000
E 5/2 0/0 transparent	900104	1.45	1.5	1.5	24	-10/+70		3100 ³⁾
E 20/3 0/V/0 SE grey	906734	3	3.5	15	125	-10/+70		3100 ³⁾
E – Polyester								
E 3/1 E0/E0 TT transparent	900339	0.9	0.65	3	40 ⁸⁾ /r3	-30/+100		3500/4700 ⁴⁾
E 3/1 E2/E2 MT/GL-C-TT transparent	900340	1.15	1.3	4.5	24	-30/+100	92	2870
E 8/2 E0/E0 TT transparent	900342	1.3	1.2	5.5	24	-30/+100		3100 ³⁾
E 10/2 E0/E10 VN-TT transparent	900343	4.4	3.3	13	60	-30/+100	92	1500 ³⁾
E 12/2 E0/E3 MT-TT transparent	900348	1.7	1.8	10.5	50/d16	-30/+100	92	3100 ³⁾ /4550 ⁴⁾
E 12/2 E3/E3 STR/MT-TT transparent	900349	2.2	2.45	12	50	-30/+100	92	3100 ³⁾
E 18/3 E0/E3 MT-TT transparent	900350	2.6	2.8	14	60	-30/+100	92	3000 ³⁾
G – Rubber								
E 3/2 U0/G8 NSTR green	900369	2	2	3.5	30	-30/+100	65	1450 ³⁾ /2240 ⁴⁾
E 3/2 U0/G10 STR green	900314	2	2.2	5	30	-30/+100	65	1500 ³⁾ /2400 ⁴⁾
E 12/2 U0/G10 GSTR green	900319	2.5	2.6	8.5	60	-30/+100	65	1500 ³⁾ /2400 ⁴⁾
E 12/2 U0/G20 AR black	906447	5.5	4	7	90	-30/+100	65	1450 ³⁾ /2400 ⁴⁾
E 12/2 U0/G20 AR green	906217	5.5	4	8	90	-30/+100		1450 ³⁾ /2400 ⁴⁾
E 12/2 U0/G20H AR green	906216	5.5	4	9	90	-30/+100	75	1450 ³⁾ /2400 ⁴⁾
L – Leather								
E 8/2 U0/L25 silver grey	900418	4.45	4.5	7.5	90 ⁶⁾	-10/+70		1050 ³⁾
N/F/Z-NOVO/polyester felt/polyester web								
E 2/1 0/V/NOVO NA-Q grey	906500	1.65	1.45	1.5	24	-10/+70		1400
E 6/1 U0/F20 white	900130	2.5	1.4	4	50 ⁸⁾ /r4	-30/+100		1500 ³⁾
E 10/1 U1/Z30 Q white	906707	4.2	1.9	8	40	-30/+100		1450
NOVO 25 NA green	906633	2.5	1.3	7	40	-10/+120		2000 ³⁾
NOVO 25 NA white FDA	996160	2.5	1.3	7	40	-10/+120		2000 ³⁾
NOVO 25 HC black	900195	2.8	1.3	7	40	-10/+120		2000 ³⁾
NOVO 25 HC-SE black	906235	2.8	1.3	7	40	-10/+120		2000 ³⁾
NOVO 40 NA green	900222	4	2.2	7.5	90	-10/+120		2000 ³⁾
NOVO 40 HC black	900221	4	2.2	7.5	90	-10/+120		2000 ³⁾
NOVO 40 HC-SE black	906236	4	2.2	7.5	90	-10/+120		2000 ³⁾
NOVO 40 NA SM/SM white FDA	900429	4	2.2	7.5	90	-10/+120		2000 ³⁾
NOVO 60 NA green	900285	5.5	3.1	8	125	-10/+120		2000 ³⁾
NOVO 60 HC black	900286	5.5	3.1	8	125	-10/+120		2000 ³⁾
NOVO 60 HC-SE black	906237	5.5	3.1	8	125	-10/+120		2000 ³⁾
P – Polyamide								
E 4/1 P2/P2 MT/MT-HC black	906396	0.75	0.8	3.5	60	-30/+100	75	3500
E 4/2 U0/P2 MT-HC black	906212	0.9	0.9	4	60	-30/+100	75	3500 ³⁾
E 10/2 0/P2 GL transparent	906459	1.9	1.9	11	40	-10/+100		3100
E 15/2 P2/P2 GL/GL transparent	906515	1.9	2	7	125	-10/+100	63	2000 ³⁾
R – HighGrip								
E 4/1 U0/R2 HACCP-FF white FDA	906665	1.15	1.15	3	40 ⁸⁾ /r3	-30/+100	55	3100
E 4/2 U0/R2 HACCP-FF white FDA	906705	1.35	1.55	5	60 ⁸⁾ /r3	-30/+100	76	3100 ³⁾
E 8/2 0/R10 S/LG black	906630	2.5	2.3	7.5	40	-30/+100	55	3000
E 8/2 U0/R15 LG-SE black	906706	3.2	3	8	60	-30/+100	45	3000 ³⁾

	Food compliance with EC/FDA/Halal directive***	Belt edge sealing****	Stiff laterally	Troughable	Suitable for knife edges	Very low noise	Suitable as a curved belt	Good heat conductivity	Profiles on the top face/underside/side wall	Samples included in collection 215/availability*****
	E/F	5)		●					-/-/-	●
	E/F	5)		●					-/-/-	●
	E/F	P,S	○	○	●			●	●/●/-	●
	E/F	S		●					-/●/-	●
	E/F	5)	○	○					●/●/-	●/C
	E/F	S	○	○		●			-/●/-	●
	E/F	5)	○	○		●			●/●/-	●
	E/F	P,S	○	○		●			-/●/-	●/C
	E/F	S	○	○					●/●/-	●
	E/F	S	○	○					●/●/-	●
	E/F/H	S		●	●				●/●/-	●/C
	E/F/H	S		●	●				-/●/-	●
	E	P,S		●	●	●			-/●/-	●
	E	5)		●	●	●			-/●/-	●
	E	S		●	●	●			-/●/-	●
	E/H	P,S		●	●	●	●		●/●/-	●
		5)	●						●/●/-	●/C
	E/F	5)	●		●				●/●/-	●
	E/F	S		●					●/●/-	●
	E/F	5)	●						●/●/-	●/C
	E/F	S	○	○		●			-/●/-	●
	E/F	5)	●	○	○ ⁷⁾				●/●/●	●
	E/F	5)	●	○					●/●/●	●/C
	E/F	S	●						●/●/●	●
			●						-/●/-	●/C
			●						-/●/-	●
			●						-/●/-	●
			●			●			-/●/-	●
			●			●			-/●/-	●/C
		5)	●		●		○		-/●/-	●/C
				●					-/●/-	●
				●		●	●		-/●/-	●/C
	E			●		●	●		●/●/-	●
				●		●	●		●/●/-	●
				●		●	●		●/●/-	C
				●		●	●		●/●/-	●
				●		●	●		●/●/-	C
	E			●		●	●		●/●/-	●/C
			○	●		●	●		●/●/-	●
			○	●		●	●		●/●/-	●
			○	●		●	●		●/●/-	C
		5)	●						-/-/-	●
		P,S	●						●/●/-	●
		S	●			●			●/●/-	●
		5)		●					●/●/-	●/C
	E/F	S	●		●				-/●/-	●
	E/F/H	S	●		●				●/●/-	●
		S	●			●	●		●/●/-	●
		S	●			●			●/●/-	●

Please note: the values stated are nominal and can fluctuate in a belt whose width is a result of production processes. Our products are constantly adapted to market requirements. Consequently, changes in technical parameters can occasionally occur.
Therefore, please see the current product data sheets for specific information on designs and calculations.

- * Established in line with ISO 21181:2005
 - ** The smallest permissible drum diameters were established at room temperature with z-splices and counter bending and do not apply to conveyor belts with mechanical fasteners. Lower temperatures, profiles and side walls can require larger drum diameters. On this point, see our brochure "Technical information 2" (ref. no. 318). rX is the radius of a fixed knife edge. dX is the diameter of a rolling knife edge.
 - *** E = (EU) 10/2011 and (EC) 1935/2004, F = Compliant to FDA 21 CFR, H = Halal certified
 - **** P = Proseal, S = Smartseal
 - ***** C = Additional range, please enquire about availability of larger quantities
 G = customised product after receipt of order
 - 1) For special applications only. Not to be used as a conveyor belt.
 - 2) Lower values for special applications possible. Please inquire.
 - 3) Larger widths with longitudinal seam possible
 - 4) Maximal widths without longitudinal seam on request
 - 5) Please enquire
 - 6) No Z-splice – see data sheet
 - 7) Rolling knife edge
 - 8) Smaller drum diameter with counter-bending on request
- Yes
●● Yes, particularly suitable
○ Partly suited, on request



MOVEMENT SYSTEMS

More types on the following double page

Standard product range

Technical data, properties and recommendations, possible applications	Article number	Total thickness approx. [mm]	Weight approx. [kg/m ²]	Effective pull at 1% elongation (k _{1%} relaxed) [N/mm width]*	d _{min} approx. [mm]**	Permissible operating temperature [°C]	Hardness of the top face coating as per DIN 53505 [Shore A]	Standard width supplied/ max. width supplied [mm]
S – Silicone								
E 3/1 U0/S3 white FDA	900184	1.1	1.05	3	40 ⁸⁾ /r3	-30/+100	30	3100
E 3/1 U0/S3 HACCP-FF blue FDA	906760	0.9	0.9	2	16/r3	-30/+100	30	3100
E 4/2 S0/S0 transparent	900135	1.3	1.1	4.5	40	-40/+180		3100
E 4/2 S0/S3 FSTR white FDA	900136	1.5	1.6	4.5	40	-40/+180	30	3100
E 6/2 U0/U/S3 white FDA	906477	1.6	1.8	5	40 ⁸⁾	-30/+100	30	3100
E 8/H S0/S5 MT-HACCP white FDA	906478	1.4	1.5	6	40 ⁸⁾ /d10 ⁷⁾⁵⁾	-40/+180	60	3000
U – Polyurethane								
E 2/1 U0/U2 NA transparent FDA	906624	0.8	0.85	3	40 ⁸⁾ /r3	-30/+100	85	1500
E 2/1 U0/U2 HACCP white FDA	900176	0.65	0.65	2.5	40 ⁸⁾ /r3	-30/+100	85	3000/4500 ⁴⁾
E 2/1 U0/U2 MT blue FDA	906546	0.6	0.6	2	40 ⁸⁾ /r3	-30/+100	92	3000/4600 ⁴⁾
E 3/1 U0/U2 DIA-NA amber FDA	906778	0.8	0.8	3	40 ⁸⁾ /r3	-30/+100	85	1050
E 3/1 U0/U2 GL-NA amber FDA	900397	0.75	0.8	3.5	40 ⁸⁾ /r3	-30/+100	85	3200
E 3/1 U0/U2 HACCP white FDA	900006	1.15	1.2	3.5	40 ⁸⁾ /r3	-30/+100	85	3000/4600 ⁴⁾
E 3/1 X0/U2D GL-HACCP-FF white FDA	906823	1	1	2.5	16/r3	-20/+100	85	3000
E 3/1 0/U2 MT-NA black	906461	0.8	0.9	3	40 ⁸⁾ /r3	-30/+100	85	3100
E 3/1 U0/U2 MT-NA-HACCP white FDA	900201	0.8	0.9	3	40 ⁸⁾ /r3	-30/+100	85	3100
E 3/1 U0/U2 MT-NA-HACCP-FF blue FDA	906662	0.9	0.9	3	14/r3	-30/+100		3200
E 3/1 X0/U2D MT-HACCP-FF white FDA	906730	1	1	2.5	14/r3	-20/+100	85	3200
E 3/1 U0/U2 MT-C-HACCP blue FDA	906602	0.7	0.7	3.5	40 ⁸⁾ /r3	-30/+100	85	3200
E 3/1 U0/U2 MT-C-HACCP white FDA	900008	0.7	0.7	3.5	40 ⁸⁾ /r3	-30/+100	85	3200
E 3/1 U0/U2 RF brown FDA	900007	1.2	1.1	3.5	40 ⁸⁾ /r3	-30/+100	85	1500
E 3/1 U0/U2 RF white FDA	906514	1.2	1.2	3.5	40 ⁸⁾ /r3	-30/+100	85	1450
E 3/1 U0/U2 RFF-NA amber FDA	900398	0.8	0.8	3	40 ⁸⁾ /r3	-30/+100	85	1630
E 3/1 U0/U2 RFF-HACCP white FDA	906726	1.15	1.1	3	40 ⁸⁾ /r3	-30/+100	85	1630
E 3/1 U0/U2 RFF-NA-HACCP-FF blue FDA	906770	0.9	0.9	3	40 ⁸⁾ /r3	-30/+100	85	1630
E 3/1 U0/U3 SP-NA amber FDA	906733	1	0.9	3	40 ⁸⁾ /r3	-30/+100	85	1500
E 3/1 U0/U5 SP white FDA	906177	1.55	1.5	2.5	40 ⁸⁾ /r3	-30/+100	85	1450
E 3/2 U0/U2 NA white FDA	900085	1.45	1.6	5.5	40 ⁸⁾ /r3	-30/+100	85	3100 ³⁾ /4600 ⁴⁾
E 3/2 U0/U2 HACCP white FDA	900103	1.4	1.6	5.5	40 ⁸⁾ /r3	-30/+100	85	3100 ³⁾ /4600 ⁴⁾
E 3/2 U0/U2 HACCP-FF blue FDA	906664	1.5	1.6	5.5	24/r3	-30/+100	85	3200 ³⁾
E 3/2 U0/U2 MT white FDA	900447	1.45	1.6	5.5	40 ⁸⁾ /r3	-30/+100	85	3000 ³⁾ /4600 ⁴⁾
E 3/2 U0/U4 DIA-HACCP white FDA	900412	2	2.2	5	24	-30/+100		1450
E 4/2 U0/U2 HACCP-FF white FDA	906645	1.35	1.55	5.5	40 ⁸⁾ /r3	-30/+100	92	3200 ³⁾
E 4/2 U0/U2 LF white	906373	1.35	1.5	4.5	40 ⁸⁾ /r3	-30/+100	85	3100 ³⁾
E 4/2 U0/U2 LF-HC black	906553	1	1.15	3	60	-10/+100	85	3650/4000 ⁴⁾
E 4/2 U0/U2 HC black	906795	1.4	1.55	4	15	-30/+100	85	3000 ⁵⁾
E 4/2 U0/U2 MT blue FDA	906540	1.35	1.55	4	40 ⁸⁾ /r3	-30/+100	92	3000 ³⁾ /4600 ⁴⁾
E 4/2 U0/U2 MT-HACCP white FDA	900207	1.35	1.55	4	40/r3	-30/+100	92	3100 ³⁾ /4600 ⁴⁾
E 4/2 U0/U2 MT-HACCP-FF blue FDA	906663	1.4	1.55	5.5	40 ⁸⁾ /r3	-30/+100	92	3200 ³⁾
E 4/2 U0/U2 QS-HACCP-FF blue FDA	906765	1.35	1.5	5	40 ⁸⁾ /r3	-30/+100	92	2000
E 4/2 U1/U2H black ATEX	906389	1.4	1.55	4.5	90	-10/+100	92	3100 ³⁾
E 4/H U8/U8 NP/MT-NA blue FDA	907139	2.5	2.8	2	40	-30/+100	92	1900
E 6/2 U0/U2 M green FDA	906191	1.9	2	5.5	50	-30/+100	85	1400 ³⁾
E 8/2 U0/U2 green FDA	900320	1.4	1.6	6.5	24	-30/+100	85	3000 ³⁾ /4550 ⁴⁾
E 8/2 U0/U2 C white FDA	999619	1.25	1.3	5.5	12	-30/+100	86	1400 ³⁾
E 8/2 U0/U2 LF green	906450	1.45	1.6	6.5	24	-30/+100	90	3000 ³⁾
E 8/2 U0/V/U2 MT black	906292	1.45	1.6	6	60	-10/+70	85	3100 ³⁾
E 8/2 U0/V/U2H MT green	900170	1.6	1.8	7.5	60	-10/+70	90	3100 ³⁾ /4700 ⁴⁾
TE 80/2 0/2U MT green	906578	1.4	1.6	6	20	-30/+100	85	3000 ³⁾
E 8/2 U0/V/U2 MT grey	900364	1.45	1.6	6	60	-10/+70	85	3100 ³⁾
E 8/2 U0/U2 MT-NA white FDA	900277	1.4	1.45	6.5	24 ²⁾	-30/+100	85	3100 ³⁾
E 8/2 U0/U2 MT-SE black	906399	1.45	1.55	6.5	14	-30/+100	85	3100 ³⁾
E 8/2 U0/V/U2H MT-SE black	906401	1.65	2	7	50	-10/+70	90	3000 ³⁾
E 8/2 U0/U2 MT-C-SE black	906391	1.2	1.4	5.5	14/d10 ⁷⁾	-30/+100	85	4300 ³⁾ /4300 ⁴⁾
E 8/2 U0/U2 STR-HC black	900154	1.6	1.8	6	25	-30/+100	94	2100 ³⁾
E 8/2 U0/U4 GSTR green	900152	2.1	2.1	5	60	-30/+100	90	1400 ³⁾
E 8/2 U0/U5 MT-HACCP white FDA	906692	1.6	1.7	6	24/r5	-30/+100	92	3200 ³⁾
E 8/2 U0/U5 MT HACCP blue FDA	906804	1.6	1.7	6	24/r5	-30/+100	92	3200 ³⁾
E 8/2 U0/U5 QS-HACCP white FDA	906777	1.6	1.7	5.5	40 ⁸⁾ /r3	-30/+100	92	2000
E 8/2 U0/U8 transparent FDA	900024	2	2.2	7.5	30	-30/+100	85	3050 ³⁾
E 8/2 0/U10 S/LG green	904358	2.3	2.2	6	40	-30/+100	73	1400 ³⁾
E 8/2 U0/U10S LG-SE black	906650	2.2	2.4	8.5	30	-30/+100	75	3000 ³⁾
E 8/2 U0/V/U20 green	900151	3.6	4.2	7	60	-10/+70	80	1550 ³⁾
E 8/H U0/U2 MT-HACCP blue FDA	906473	1.35	1.25	8.5	60/r3	-30/+100	85	3100
E 8/H U0/U2 MT-HACCP white FDA	906451	1.35	1.25	9	60 ⁸⁾ /r3	-30/+100	85	3100
E 8/H U2/U2 MT/MT-HACCP blue FDA	906604	1.6	1.7	9	60/d10	-30/+100	85	3000

Continued from previous double page

	Food compliance with EC/FDA/Halal directive***	Belt edge sealing****	Stiff laterally	Troughable	Suitable for knife edges	Very low noise	Suitable as a curved belt	Good heat conductivity	Profiles on the top face/ underside/side wall	Samples included in collection 215/availability*****
	E/F	5)	●		●			●	-/●/-	●
	E/F	5)	●		●			●	-/●/-	●
	E/F	5)	●						-/-/-	●
	E/F	5)	●						-/-/-	●
	E/F	S	●						-/●/-	●
	E/F			●	○ ⁷⁾	●		●	-/-/-	●
	E/F/H	S	●		●			●	●/●/-	●/C
	E/F/H	S	●		●			●	●/●/-	●
	E/F/H	P,S	●		●			●	●/●/-	●
	E/F/H	S	●		●				-/●/-	●/C
	E/F/H	S	●		●		○	●	●/●/-	●
	E/F/H	P,S	●		●			●	●/●/-	●
	E/F	S	●		●			●	●/●/-	●/C
	E/F/H	5)	●		●			●	●/●/-	●/C
	E/F/H	P,S	●		●			●	●/●/-	●
	E/F/H	S	●		●			●	●/●/-	●
	E/F	S	●		●			●	●/●/-	●
	E/F/H	P,S	●	●	●		●	●	-/●/-	●
	E/F/H	P,S	●	●	●		●	●	-/●/-	●
	E/F/H	P,S	●		●			●	-/●/-	●
	E/F/H	S	●		●			●	-/●/-	C
	E/F/H	5)	●		●			●	-/●/-	●
	E/F/H	S	●		●			●	-/●/-	●
	E/F/H	S	●		●			●	-/●/-	●/C
	E/F/H	5)	●		●			●	-/●/-	●/C
	E/F/H	P,S	●		●			●	-/●/-	●/C
	E/F/H	5)	●		●			●	●/●/-	●/C
	E/F/H	P,S	●		●			●	●/●/-	●
	E/F/H	S	●		●		●	●	●/●/-	●
	E/F/H	S	●		●			●	●/●/-	●/C
	E/F/H	S	●		●			●	-/●/-	●/C
	E/F/H	S	●		●			●	●/●/-	●
	E	P,S	●		●			●	-/●/-	●
		5)	●		●			●	-/-/-	●
		5)	●		○			●	5)	●/C
	E/F/H	P,S	●		●			●	●/●/-	●
	E/F/H	P,S	●		●			●	●/●/-	●
	E/F/H	S	●		●			●	●/●/-	●
	E/F/H	S	●		●			●	●/●/-	●/C
		P,S	●		●			●	-/●/-	●
	E/F	5)	●	●				●	●/●/●	●
	E/F	5)	●	●				●	●/●/●	●
	E/F	P,S	●					●	●/●/-	●
	E/F/H	5)	●	●			●	●	●/●/-	●
		P,S	●			●		●	-/●/-	●
		5)	●			●		●	●/●/-	●/C
		S	●			●		●	●/●/-	●
		5)	●			●		●	●/●/-	●/C
		5)	●			●		●	●/●/-	●/C
	E/F	P,S	●		○			●	●/●/-	●
		5)	●			●		●	●/●/-	●/C
		S	●		○	●	●	●	-/●/-	●
		P,S	●			●		●	●/●/-	●
		S	●			●		●	●/●/●	●
	E/F/H	S	●		●			●	●/●/●	●
	E/F/H	S	●		●			●	●/●/●	●
	E/F/H	S	●		●			●	●/●/-	●/C
	E/F/H	P,S	●			●		●	●/●/●	●
		S	●			●		●	●/●/-	●
		5)	●			●		●	●/●/-	●/C
		5)	●			●		●	●/●/-	●
	E/F/H	P,S	●	●	●	●		●	●/●/-	●
	E/F/H	P,S	●	●	●	●		●	●/●/-	●
	E/F/H	P,S	●	●	○ ⁷⁾	●		●	●/●/-	●

- * Established in line with ISO 21181:2005
 - ** The smallest permissible drum diameters were established at room temperature with z-splices and counter bending and do not apply to conveyor belts with mechanical fasteners. Lower temperatures, profiles and side walls can require larger drum diameters.
On this point, see our brochure "Technical information 2" (ref. no. 318).
rX is the radius of a fixed knife edge.
dX is the diameter of a rolling knife edge.
 - *** E = (EU) 10/2011 and (EC) 1935/2004, F = Compliant to FDA 21 CFR, H = Halal certified
 - **** P = Proseal, S = Smartseal
 - ***** C = Additional range, please enquire about availability of larger quantities
G = customised product after receipt of order
 - 1) For special applications only.
Not to be used as a conveyor belt.
 - 2) Lower values for special applications possible. Please inquire.
 - 3) Larger widths with longitudinal seam possible
 - 4) Maximal widths without longitudinal seam on request
 - 5) Please enquire
 - 6) No Z-splice – see data sheet
 - 7) Rolling knife edge
 - 8) Smaller drum diameter with counter-bending on request
- Yes
●● Yes, particularly suitable
○ Partly suited, on request



Standard product range

Technical data, properties and recommendations, possible applications	Article number	Total thickness approx. [mm]	Weight approx. [kg/m ²]	Effective pull at 1% elongation (k _{1%} relaxed) [N/mm width]*	d _{min} approx. [mm]**	Permissible operating temperature [°C]	Hardness of the top face coating as per DIN 53505 [Shore A]	Standard width supplied/ max. width supplied [mm]
E 8/H U0/U4 QS black	906541	1.5	1.6	7.5	24	-30/+100	85	2000
E 8/H U0/U5 NP-HACCP blue FDA	906605	1.6	1.65	9	60 ⁸⁾ /r3	-30/+100	85	3100
E 8/H U0/U5 NP-HACCP white FDA	906489	1.6	1.65	9	60/r3	-30/+100	85	3100
E 8/H U0/U6S NP black	906383	1.8	1.65	8.5	14	-30/+100	64	1450
E 10/H X0/U2 MT-HACCP transparent FDA	906557	1.25	1.15	8	14/r3	-30/+100	85	3200
E 10/M U1/U3 NA green	900064	3.1	3.3	5	60	-10/+80	80	1450 ³⁾
E 10/M U1/U3 GSTR-NA green	900065	3.5	3.4	5	60	-10/+80	80	1450 ³⁾
E 12/2 U0/V/U1 SE black	906506	2	2.3	8	60	-10/+70		2800 ³⁾
E 12/2 U1H/U1H GL/GL transparent	906195	1.5	1.6	10	90	-30/+100	95	3100
E 12/2 U0/U2 C green FDA	900041	1.85	2	5	60	-30/+100	85	4100 ³⁾
E 12/2 U0/V/U2H MT green	900173	2.2	2.55	10	80	-10/+70	90	3100 ³⁾
E 12/2 U0/U3 GSTR-C-SE black	906718	2.1	1.9	4.5	40	-30/+100	85	3000 ³⁾
E 12/2 U0/V/U4 GSTR-C black	999979	2.4	2.3	4	60	-10/+70	85	2900 ³⁾
E 12/2 U0/U4 MT black	906358	2.1	2.25	10.5	60	-30/+100	85	2670 ^{3)/4450⁴⁾}
E 12/2 U0/U6S GSTR-C black	906562	2.3	2.2	5	30	-30/+100	65	3000 ³⁾
E 12/2 U0/U10 GSTR green	906792	3	3.2	11	60	-30/+100	92	3000 ³⁾
E 12/2 U0/U20 GSTR green	900168	3.8	3.8	10	90	-10/+80	80	1600 ³⁾
E 14/2 U0/U4 M MT white FDA	906698	2.9	3	16	50	-30/+100	85	1300 ^{3)/3000⁴⁾}
E 18/3 U0/V/U2H MT green	900174	2.8	3.2	17	160	-10/+70	90	3050 ^{3)/4550⁴⁾}
E 18/H UH/U2 MT black	906818	1.65	1.65	18	160 ²⁾	-30/+100	92	3000
E 18/H UH/U2 MT white FDA	906420	1.75	1.75	19	20 ²⁾	-30/+100	85	4750 ³⁾
E 20/2 U0/U7 MT black	906683	2.6	2.8	14	60	-30/+100	92	1400 ³⁾
E 20/M U1/U3 NA green	900074	5.4	6	9	160	-10/+80	80	1600 ³⁾
E 20/M U1/U3 GSTR-NA green	900075	5.7	6	8	160	-10/+80	80	1600 ³⁾
EP U5/U5 GL/GL-NA green	900205	7.3	6.5	6.5	125 ¹⁾	-10/+80	92	2100
PRINT 6646-2.15E	906646	2.15	2.25	15	60	-30/+70	92	4400 ³⁾
PRINT 6488-2.65E	906488	2.65	3	13	60	-30/+70	92	4400 ³⁾
PRINT 6552-2.15AE	906552	2.2	2.4	70	125	-30/+70	92	3000
AE 140/3 U0/U4H MT black	906441	3.7	4.2	75	250	-30/+100	92	4200
U0/UH – Fabric, polyurethane impregnated								
E 3/1 U0/U0 blue FDA	906681	0.85	0.7	3	40 ⁸⁾ /r3	-30/+100		3100
E 3/1 U0/U0 transparent FDA	906430	0.85	0.6	3	40 ⁸⁾ /r3	-30/+100		3000/4500 ⁴⁾
E 3/2 U0/U0 transparent FDA	900009	1.2	1.1	5	40 ⁸⁾ /r3	-30/+100		4600 ³⁾
E 4/2 U0/U0 transparent FDA	900206	1.1	1.1	3.5	24 ⁸⁾ /r3	-30/+100		3200/4650 ⁴⁾
E 4/2 U0/U0 HACCP-FF blue FDA	906723	1.05	0.9	4	30 ⁸⁾ /r3	-30/+100		3100
E 6/1 U0/UH green	900019	0.6	0.6	5.5	24/r5	-30/+100	95	3100
E 6/2 U0/U0 blue FDA	906558	1	0.9	4	40 ⁸⁾ /r3	-30/+100		3100 ³⁾
E 12/2 U0/V/U0 anthracite	906458	2.05	2.2	11	60	-10/+70		3000 ³⁾
E 12/2 U0/V/U0 transparent	900164	1.5	1.55	11	60	-10/+70		3100 ³⁾
E 12/2 U0/UH green	906509	1.45	1.5	9	40	-30/+100	95	3100 ³⁾
E 12/2 U0/UH transparent	900042	1.45	1.5	9	40	-30/+100	95	3100 ³⁾
E 12/2 U0/U0 transparent FDA	900040	1.4	1.4	11	60	-30/+100		3000 ^{3)/4650⁴⁾}
E 12/2 U0/U0 C transparent	900163	1.55	1.5	4	60	-30/+100		3000 ³⁾
E 12/2 U0/V/U0 SE black	999903	2	2.3	11	60	-10/+70		3000 ³⁾
E 12/3 U0/V/U0 transparent	996053	2.2	2.3	10	90	-10/+70		3000 ³⁾
E 18/H U0/UH HC black	906653	1.75	1.85	20	160	-30/+100	92	3100
V – Polyvinyl chloride								
E 4/1 V4H/V4H MT/STR green	906226	1.4	1.7	3.5	30	-10/+70	85	3100 ³⁾
E 4/1 U0/V5H MT green	900171	1.1	1.25	3.5	30	-10/+70	85	3100/4600 ⁴⁾
E 4/1 V1/V5H MT-SE black	906626	1	1.4	3.5	60	-10/+70	85	3000
E 5/2 U0/V3 MT-NA white FDA	900015	1.85	2.15	3.5	40 ⁸⁾ /r3	-10/+70	65	2800 ³⁾
E 5/2 U0/V5 green	900016	1.95	2.3	3.5	24	-10/+70	75	3000 ^{3)/4400⁴⁾}
E 5/2 U0/V5H MT black	906176	1.9	2.2	3.5	20	-10/+70	85	2800 ³⁾
E 5/2 U0/V5H MT grey	906202	1.9	2.2	4	40	-10/+70	85	2570 ³⁾
E 5/2 U0/V5 NP-SE black	999802	2.1	2.2	4	40	-10/+70	48	2900 ³⁾
E 6/1 V1/V14 MT-NA white	906639	2	2.25	6	40 ¹⁾	-10/+70	62	3100
E 8/2 V1/V1 blue	996060	2	2.35	5.5	50	-10/+70 ²⁾		3100 ³⁾
E 8/2 V1/V1 grey	906476	2	2.35	5.5	50	-10/+70 ²⁾		3100 ³⁾
E 8/2 V1/V1 NA orange	996088	2	2.35	5.5	50	-10/+70 ²⁾		3100 ³⁾
E 8/2 V1/V1 NA red	906174	2.05	2.4	5.5	40	-10/+70 ²⁾		3100 ³⁾
E 8/2 V1/V1 NA yellow	906481	2	2.35	5.5	50	-10/+70 ²⁾		3100 ³⁾
E 8/2 U0/V2H MT green	900208	1.5	1.65	7.5	40	-10/+70	85	3000 ^{3)/4500⁴⁾}
E 8/2 Y0/V4 GSTR black	996125	2.1	2.25	5.5	40	-10/+70	70	3000 ³⁾
E 8/2 U0/V4 MT blue FDA	906595	2.1	2.3	6	30	-10/+70	72	3100 ³⁾
E 8/2 U0/V4H MT black	906762	1.9	2.1	8	40	-10/+70	85	3100 ³⁾
E 8/2 U0/V5 GL black	906816	2.1	2.35	8	40	-10/+70	63	3150 ³⁾

Continued from previous double page

	Food compliance with EC/FDA/Halal directive***	Belt edge sealing****	Stiff laterally	Troughable	Suitable for knife edges	Very low noise	Suitable as a curved belt	Good heat conductivity	Profiles on the top face/ underside/side wall	Samples included in collection 215/availability*****
		5)		○		●			●/●/-	●/C
	E/F/H	P,S		●	●	●			●/●/-	●
	E/F/H	P,S		●	●	●			●/●/-	●
		5)				●			●/●/-	●
	E/F/H	S		●	●	●			●/●/-	●
		5)		●			○		●/●/●	●
		5)		●		●	○		●/●/-	●
		5)	●●			●			●/●/-	●/C
		5)	●●						●/●/-	●/C
	E/F	P,S		●			●		●/●/-	●/C
		P,S	●●			●			-/●/-	●
		5)		●			●		●/●/-	●/C
		5)		●			●		●/●/-	●
		5)	●						●/●/●	●
		5)		●			●		●/●/-	●/C
		5)	●						●/●/-	●
	E/F/H	5)	●●			●			●/●/●	●
		5)	●●						●/●/●	●
		5)	●						-/●/-	●
	E/F/H	S	●						5) ●/●/-	●/C
	E/F/H	P,S	●	○					●/●/-	●
		5)	●						●/●/●	●/C
		5)	○	○					●/●/●	●
		5)	○	○					●/●/-	●
		5)	●●						-/●/-	●
		5)	●			●			●/●/●	●
		5)	●			●			●/●/●	●
		5)	●●			●			●/●/-	●/C
		5)	●●						●/●/-	●
	E/F/H	5)	●		●			●	●/●/-	●
	E/F/H	P	●		●				●/●/-	●
	E/F/H	P,S	●		●				●/●/-	●
	E/F/H	S	●		●				●/●/-	●
	E/F/H	S		●	●			●	●/●/-	●
		5)	●		●				-/●/-	●
	E/F/H	P,S	●		●				●/●/-	●
		5)	●●			●			●/●/-	●
		P	●	○		●			●/●/-	●
		P	●●			●			●/●/-	●
		P,S	●●			●			-/●/-	●
	E/F/H	S	●●			●			●/●/-	●
		P,S	●	●			●		●/●/-	●
		5)	●●			●			●/●/-	●
		5)	●			●			●/●/-	●/C
		5)	●						-/●/-	C
		P,S	●						●/●/-	●
		P,S	○	●					●/●/-	●
		5)	●						●/●/-	●/C
	E/F/H	P,S		●			●		●/●/-	●
		P,S		●		●	●		●/●/-	●
		5)		●		●	●		●/●/-	●
		5)		●		●			●/●/-	C
		5)		●		●	●		-/●/-	●
		5)	●						-/●/-	C
		P,S	●	○					●/●/-	●
		5)	●						●/●/-	●/C
		5)	●						●/●/-	●
		5)	●						●/●/-	C
		5)	●						●/●/-	C
		P,S	●						●/●/-	●
		S	●	○		●●			●/●/-	●
	E/F/H	P,S	●			●			●/●/-	●
		5)	●			●			●/●/-	●
		5)	●			●●			●/●/-	●/C

* Established in line with ISO 21181:2005

** The smallest permissible drum diameters were established at room temperature with z-splices and counter bending and do not apply to conveyor belts with mechanical fasteners. Lower temperatures, profiles and side walls can require larger drum diameters.

On this point, see our brochure "Technical information 2" (ref. no. 318).
 rX is the radius of a fixed knife edge.
 dX is the diameter of a rolling knife edge.

*** E = (EU) 10/2011 and (EC) 1935/2004, F = Compliant to FDA 21 CFR, H = Halal certified

**** P = Proseal, S = Smartseal

***** C = Additional range, please enquire about availability of larger quantities
 G = customised product after receipt of order

1) For special applications only.
 Not to be used as a conveyor belt.

2) Lower values for special applications possible. Please inquire.

3) Larger widths with longitudinal seam possible

4) Maximal widths without longitudinal seam on request

5) Please enquire

6) No Z-splice – see data sheet

7) Rolling knife edge

8) Smaller drum diameter with counter-bending on request

● Yes
 ●● Yes, particularly suitable
 ○ Partly suited, on request



MOVEMENT SYSTEMS

More types on the following double page

Standard product range

Technical data, properties and recommendations, possible applications	Article number	Total thickness approx. [mm]	Weight approx. [kg/m ²]	Effective pull at 1% elongation (k _{1%} relaxed) [N/mm width]*	d _{min} approx. [mm]**	Permissible operating temperature [°C]	Hardness of the top face coating as per DIN 53505 [Shore A]	Standard width supplied/ max. width supplied [mm]
E 8/2 0/V5 GL-SE black	906817	2.1	2.35	8	40	-10/+70	63	3150 ³⁾
E 8/2 U0/V5 green	900025	2.1	2.5	7.5	30	-10/+70	75	4600 ³⁾
E 8/2 0/V5H S/MT black	996141	2.2	2.5	8	40	-10/+70	85	3000 ^{3)/4500⁴⁾}
E 8/2 U0/V5H MT black	900026	2.2	2.5	7.5	40	-10/+70	85	3100 ^{3)/4600⁴⁾}
E 8/2 U0/V5 MT white FDA	900028	2.2	2.5	7	30	-10/+70	65	4500 ³⁾
E 8/2 U0/V5H MT-SE black	999967	2.25	2.7	8	50	-10/+80	85	3200 ^{3)/4100⁴⁾}
E 8/2 U0/V5 NP white FDA	900029	2.1	2.15	7	40	-10/+70	65	3100 ³⁾
E 8/2 U0/V5 STR green	900027	2.4	2.7	6	30	-10/+70	75	3100 ³⁾
E 8/2 V5/V5 STR/GL black	906534	2.65	3.2	6	40	-10/+70	75	3100 ³⁾
E 8/2 V5/V5 STR/GL green	900030	2.65	3.2	7	40	-10/+70	75	3100 ³⁾
E 8/2 U0/V7 SG black	906286	2.3	2.45	6.5	40	-10/+70	45	3100 ³⁾
E 8/2 V5/V8 NP/MT blue FDA	906567	2.85	3.2	6	40	-10/+70	72	3100 ³⁾
E 8/2 U0/V10H M-SE black	906538	3.1	3.6	8	60	-10/+70	85	4400 ³⁾
E 8/2 0/V10 LG black	906764	2.7	2.9	8	40	-10/+70	42	3100 ³⁾
E 8/2 U0/V10 LG anthracite	906593	2.6	2.6	6.5	40	-10/+70	45	3100 ³⁾
E 8/2 U0/V10 RPH black	906591	4.7	3.15	6.5	60	-10/+70	75	1600
E 8/2 U0/V10 SG green	900086	2.6	2.85	7	40	-10/+70	45	3100 ³⁾
E 8/2 U0/V15 LG green	900199	3.1	3.4	8	40	-10/+70	45	3100 ³⁾
E 8/2 U0/V15 LG black	900275	3.1	3.4	7.5	40	-10/+70	45	3100 ^{3)/4550⁴⁾}
E 8/2 U0/V15 LG-SE black	906313	3.1	3.4	8	40	-20/+80	45	3000 ^{3)/4600⁴⁾}
E 8/2 U0/V18 TRI blue FDA	906612	3.5	3.5	5	60	-10/+70	72	1250
E 8/2 U0/V20 AR black	900087	4.9	4	6	40	-10/+70	45	3100 ³⁾
E 8/2 U0/V20 AR green	900037	4.9	4	6	40	-10/+70	45	3100 ³⁾
E 8/2 U0/V20 AR-SE black	999532	4.9	4.2	8	60	-20/+80	45	2000 ³⁾
E 8/2 U0/V20 KN green	900139	3.6	3.2	6.5	60	-10/+70	45	1600 ³⁾
E 8/2 U0/V30 STR red	906668	5.6	6	5.5	60	-10/+70	48	3100 ³⁾
E 8/2 U0/V80 CH-SE black	906277	8.2	4.4	6.5	125	-10/+70	45	1450
E 8/2 U0/V80 R80-SE black	996121	8.2	4.7	6	125	-10/+70	45	1450
E 8/H U0/V4 GSTR black	906350	1.75	1.5	9.5	24	-10/+70	70	2900
E 8/H U0/V6 NP black	906386	1.85	1.6	9	14	-10/+70	45	1500
E 8/H U0/V10S LG black	906446	2.15	2.1	9	60	-10/+70	25	3100
E 10/2 TX0/V5H MT-SE-AMP black	906809	2.15	2.4	9.5	40	-10/+50	85	3000 ³⁾
E 10/2 TX0/V5H MT-AMP black	906807	1.9	2.1	9.5	40	-10/+50	85	3000 ³⁾
E 10/2 TX0/V15 LG-AMP black	906808	2.7	2.9	9.5	40	-10/+50	40	3000 ³⁾
E 10/2 TX0/V15 LG-SE-AMP black	906810	2.7	2.9	9.5	40	-10/+50	42	3000 ³⁾
E 10/M V1/V10 green	900066	2.85	3.3	6	60	-10/+70	65	2000 ³⁾
E 10/M V1/V10 MT blue FDA	906533	2.85	3.3	6	60	-10/+70	56	3100 ³⁾
E 10/M V1/V10 MT white FDA	900092	2.85	3.3	5.5	60	-10/+70	55	3000 ³⁾
E 10/M V1/V20 AR black	900069	5	4.1	5	60	-10/+70	45	3100 ³⁾
E 12/2 U0/V3 C green	900044	2.3	2.7	4	60	-10/+70	75	4100 ³⁾
E 12/2 0/V3 GSTR-C-SE anthracite	906784	2.1	2.35	4	30	-10/+70	70	3350 ³⁾
E 12/2 U0/V3 MT-C black	900264	2.3	2.7	4	60	-10/+70	75	4100 ³⁾
E 12/2 U0/V6 GSTR-C-SE black	906495	2.65	2.7	4	30	-15/+70	70	4100 ³⁾
E 12/2 U0/V7 green	900045	2.85	3.4	12	60	-10/+70	75	4650 ³⁾
E 12/2 U0/V10 STR-SE black	900323	3.1	3.8	9.5	60	-10/+70	80	3100 ³⁾
E 12/2 V5/V10 STR/GL green	900053	3.25	3.9	11.5	60	-10/+70	75	3100 ³⁾
E 12/2 U0/V20 green	900262	3.35	4.1	11	60	-10/+70	75	3100 ³⁾
E 12/2 U0/V20 FG-NA white FDA	900051	5.2	3.9	9.5	60	-10/+70	65	1500 ³⁾
E 12/2 U0/V20 MT-NA white FDA	900050	3.7	4.4	10	60	-10/+70	65	3100 ³⁾
E 12/2 U0/V40 FG-NA green	906297	7.5	6.5	10	90	-10/+70	75	1550 ³⁾
E 12/2 U0/V40 R green	996119	6.1	5.45	9	90	-10/+70	45	1550 ³⁾
E 15/2 U0/V5 MT green	906728	2.6	2.9	11	90	-10/+70	75	3000 ³⁾
E 15/2 U0/V5 STR green	906279	2.6	2.9	11	90	-10/+70	75	3100 ³⁾
E 15/2 U0/V7S SG black	906815	2.3	2.45	10	60	-10/+70	21	3050 ³⁾
E 15/3 U0/V20 C green	906702	4.7	5.5	6	125	-10/+70	66	3100 ³⁾
E 15/M V1/V10H MT green	900324	5	5.4	10	125	-10/+70	85	2950 ³⁾
E 15/M V1/V10 MT white FDA	900093	5	5.3	9.5	125	-10/+70	65	3000 ³⁾
E 18/3 U0/V5H MT-SE black	906395	3	3.7	16	90	-10/+70	85	3100 ³⁾
E 18/3 U0/V20 green	900088	4.8	5.7	16	125	-10/+70	75	3000 ³⁾
E 18/3 U0/V20 STR white	906394	4.85	5.8	15	125	-10/+70	85	3100 ³⁾
E 20/3 0/V20 LG-SE black	906740	4.4	5	15	90	-10/+70	75	3000 ³⁾
E 30/3 U0/V25 GSTR green	906387	6.2	7	30	350 ²⁾	-10/+70	75	3100 ³⁾
E 44/3 U0/V20 green	999995	5.8	7	35	160	-10/+70	75	3000 ³⁾
PRINT 6785-3.OAE SG	906785	3	3.2	45	125	-10/+70	42	1450

Continued from previous double page

Food compliance with EC/FDA/Halal directive***	Belt edge sealing****	Stiff laterally	Troughable	Suitable for knife edges	Very low noise	Suitable as a curved belt	Good heat conductivity	Profiles on the top face/underside/side wall	Samples included in collection 215/availability*****
	5)	●			●●			●/●/-	●/C
	P,S	●			●●			●/●/-	●
	S	●			●●			●/●/-	●
E/F/H	P,S	●			●			●/●/-	●
E/F/H	P,S	●			●			●/●/-	●
	S	●						●/●/-	●
	P,S	●						●/●/-	C
	P,S	●						●/●/-	●
E/F/H	P,S	●						●/●/-	●
	5)	●●			●			●/●/●	●
	5)	●			●			●/●/-	●
	5)	●			●			●/●/-	C
	5)	●			●			-/●/-	C
	P,S	●			●			●/●/-	●
	P,S	●			●			●/●/-	●
	5)	●			●			●/●/-	●
E/F/H	P,S	●			●			●/●/-	●
	5)	●			●			●/●/-	●
	5)	●			●			●/●/-	●
	5)	●			●			-/●/-	C
	5)	●			●			-/●/-	C
	5)	●			●			-/●/-	●
	5)	●	●		●			●/●/-	●/C
	S	●	●		●			●/●/-	●
	5)	●			●			●/●/-	●
	5)	●			●			●/●/-	●
	5)	●			●			●/●/-	●
	5)	●			●			●/●/-	●
	5)	●			●			●/●/-	●
	5)	●			●			●/●/-	●
E/F/H	P,S	●	●		●	○		●/●/●	●
E/F/H	S	●	●		●	○		●/●/●	●
	P,S	●	●		●	○		-/●/-	●
	S	●	●		●	●		●/●/-	●
	5)	●	●		●	●		●/●/-	●
	5)	●	●		●	●		●/●/-	●/C
	5)	●●	●		●	●		●/●/●	●
	5)	●	●		●	●		●/●/●	●
E/F/H	P,S	●●	●		●	●		●/●/●	●
E/F/H	P,S	●●	●		●	●		-/●/-	●
	5)	●●	●		●	●		-/●/-	C
	5)	●●	●		●	●		-/●/-	●
	S	●	●		●	●		●/●/●	●/C
	5)	●	●		●	●		●/●/-	●/C
	5)	●	●		●	●		●/●/-	●/C
	5)	●	●		●	●		●/●/●	●/C
E/F/H	5)	○	○		●	○		●/●/●	●
E/F/H	5)	○	○		●	○		●/●/●	●
	5)	●	●		●	●		●/●/●	●/C
	5)	●	●		●	●		●/●/●	●
	5)	○	○		●	●		●/●/-	●/C
	5)	●	●		●	●		●/●/-	●/C
	5)	●	●		●	●		●/●/-	●
	S	●	●		●	●		●/●/-	●/C

- * Established in line with ISO 21181:2005
- ** The smallest permissible drum diameters were established at room temperature with z-splices and counter bending and do not apply to conveyor belts with mechanical fasteners. Lower temperatures, profiles and side walls can require larger drum diameters. On this point, see our brochure "Technical information 2" (ref. no. 318). rX is the radius of a fixed knife edge. dX is the diameter of a rolling knife edge.
- *** E = (EU) 10/2011 and (EC) 1935/2004, F = Compliant to FDA 21 CFR, H = Halal certified
- **** P = Proseal, S = Smartseal
- ***** C = Additional range, please enquire about availability of larger quantities
G = customised product after receipt of order
- 1) For special applications only. Not to be used as a conveyor belt.
- 2) Lower values for special applications possible. Please inquire.
- 3) Larger widths with longitudinal seam possible
- 4) Maximal widths without longitudinal seam on request
- 5) Please enquire
- 6) No Z-splice – see data sheet
- 7) Rolling knife edge
- 8) Smaller drum diameter with counter-bending on request
- Yes
- Yes, particularly suitable
- Partly suited, on request



Code and abbreviations

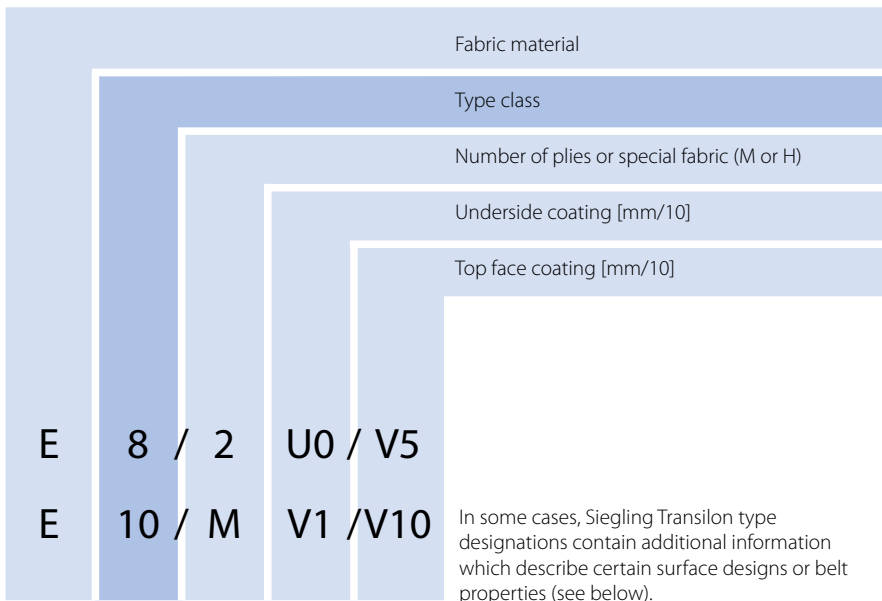

Tension member construction

AE	Aramid/polyester blended fabric
E	Polyester
EP	Polyester/polyamid blended fabric
P	Polyamide

Design

1,2,3	Number of fabric plies
M	Solid-woven material
NOVO	Polyester felt
H	HiTech-fabric

Coatings

A	Polyolefin
C	Cotton
E	Polyester
G	Rubber/elastomer
G...H	Rubber/elastomer hard
L	Leather
P	Polyamide
S	Silicone
R	High grip
U	Polyurethane
U...D	Polyurethane, dehesive
U...H	Polyurethane hard (Duroplast)
U...S	Polyurethane soft
V	PVC
V...H	Hard PVC
V...S	Soft PVC
O	Fabric, uncoated
F, Z	Felt/velour
U0, E0, A0	Impregnated
S0, Y0, UH	

Top face patterns

AR	Anti-skid
CH	Check-in
DIA	Diagonal
FG	Herringbone
FSTR	Fine textured pattern

GL Smooth surface

GSTR Coarse textured pattern

KN Cross-stud pattern

LG Longitudinal groove

MT Matt surface

NP Inverted pyramid

NSTR Normal pattern, fine

QS Quartz sand

R Large diamond

RF Fine rhomboid

RFF Flat fine rhomboid

RPH High round profile

R80 Check-in, rhomboid

SG Lattice

SP Star pyramid

STR Normal textured pattern

TRI Triangle, crosswise

VN Vertikal stud

ROUGH Rough pattern

FINE Fine Pattern

Belt properties

ATEX Explosion prediction with specific compliance to guidelines

C Laterally soft

FDA Conformity to FDA

HACCP Supports the HACCP concept

HC Highly-conductive

LF Low friction

M Particularly stiff laterally

NA Non-antistatic

S Very low noise

SE Flame-retardant

TT Pyrolysis compliant

Q Laterally soft

Product brochures (selected)*

Ref. no. Subject

217 Siegling Belting image brochure
– Movement is our business

Overview of the product range

214 Siegling Transtex conveyor belts
215 Siegling Transilon – Standard product range
216 Siegling Extremultus – Standard product range
225 Siegling Extremultus power transmission belts
229 Siegling Transilon round belts
244 Siegling Linpack folder and carrier belts
245 Siegling Proposition timing belts
800 Siegling Prolink modular belts

Application brochures (sectors)

193 Tyre Industry
194 Metalworking
228 Tobacco
232 Conveyor and timing belts for drag band conveyors
242 Airports
262 Wood
263 Sports
266 Logistics
269 Food
295 Textiles – Nonwovens

Technical Information

304 Siegling Transilon – Calculation methods for conveyor belts
305 Siegling Transilon – Recommendations for machine design
317 Siegling Transilon – Technical information 1
(Storage, Finishing, Fitting)
318 Siegling Transilon – Technical information 2
(Special features and properties)



MOVEMENT SYSTEMS

Siegling – total belting solutions

Committed staff, quality-orientated organisation and production processes ensure the constantly high standards of our products and services. The Forbo Siegling Quality Management System is certified in accordance with ISO 9001.

In addition to product quality, environmental protection is an important corporate goal. Early on we also introduced an environmental management system, certified in accordance with ISO 14001.

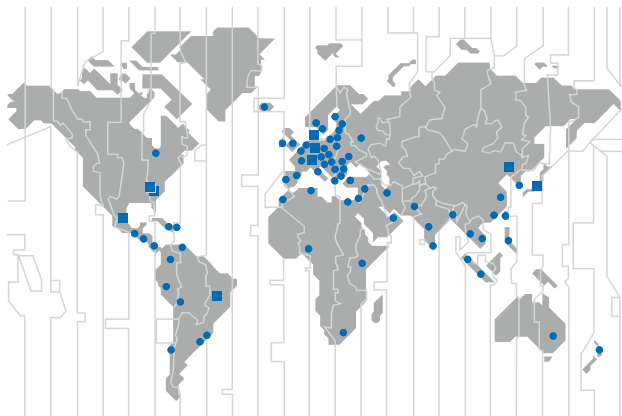

Forbo Siegling service – anytime, anywhere

The Forbo Siegling Group employs more than 2,000 people. Our products are manufactured in nine production facilities across the world. You can find companies and agencies with warehouses and workshops in over 80 countries. Forbo Siegling service points are located in more than 300 places worldwide.