

Cam switches

series
T|TB|TF|TP

Cam switches available in different construction models over a wide current range with a large variety of accessories.

According to:
IEC 60947-3
UL508 - CAN/CSA C22.2 N° 14
RoHS

Testing and approvals:
CE c UL US EAC BUREAU VERITAS APPROVED R CCC



Cam switches are manufactured in different series under strict quality controls to provide a reliable product that meets the most demanding requirements.

They consist of chambers, each containing up to two double break contacts of positive opening. These contacts silver alloy plated providing a long electromechanical life.

In sizes 0 - 1 and 2, the terminals are equipped with captive clamp screws to facilitate installation work, and all the connections themselves are covered to provide an IP20 protection rating.

The different configurations of contacts available provide flexible, faster and safer solutions for several electrical operations at a highly competitive cost.

Range codification:

Standard products

They are listed in this section and are encoded according to the 16-digit bar logic explained below. This descriptive method will be used on all pages in the cam switches range for your convenience and better understanding.

Special products

They are made according to customer specifications or to comply with a diagram or special scheme. In these cases, the code is formed by the corresponding series (T-TB-TF-TP), the amperage and an order number assigned to the scheme (see blank diagrams form on page 33).

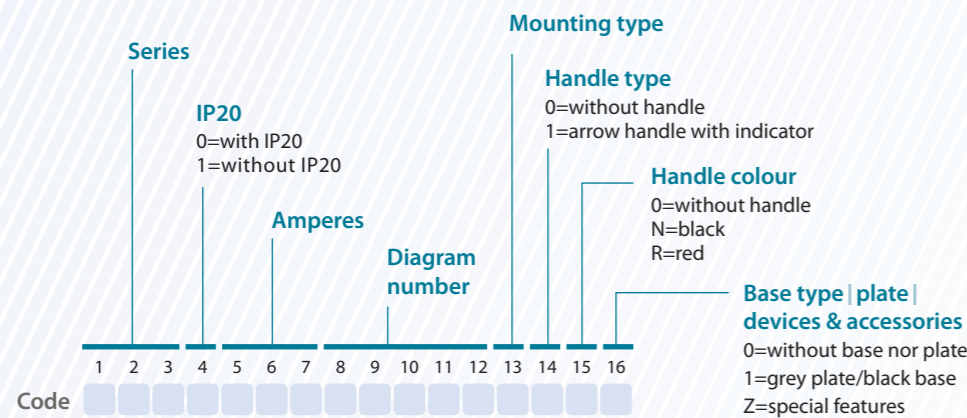

Example **T-0010000012E1N1**
T series | 100 amperes | 012 diagram | E fixing | Standard handle | Black colour | Grey plate/black base

series T



Wide range of sizes and ratings.
Supplied with IP20 removable terminals protection on sizes 0 - 1 - 2 (except T175).
Wide range of devices and accessories.

series TB



Side access to all terminal screws (up and down).
Two different bodies depending on mounting type: door or base mounting.
Wide range of devices and accessories.

series TF



Square body, smooth sides, axial access to terminal screws.
Two different bodies depending on mounting type: door or base mounting.
Wide range of devices and accessories.

series TP



Reduce-sized body.
Door mounting only.
Wide range of devices and accessories.

series | type TIP



- > Cam switch in plastic enclosure for gland entry.
- > From 12 up to 40 A.
- > Padlockable handle under request.

series | type T-TF|R



- > Cam switch in plastic enclosure for gland entry.
- > From 25 up to 100 A.
- > Padlockable handle under request.

series | type T-TB|A-C



- > Cam switch in metal enclosure of cast aluminium
A From 12 up to 63 A.
- > In sheet steel enclosure
C From 100 A upwards.
- > Gland entry.
- > Several enclosure sizes.
- > Padlockable handle under request.

>> Ask for more information about these applications with enclosure.



TP|T|TB|TF

Door mounting

Fixing with screws | E type

For T - TB - TF - TP series

- > Frontal fixing plate for 4 screws, reversible mounting plate in T series (except T175 and size 3).
- > Door mounting with arrow handle, indicating plate, escutcheon and fixing plate IP65.

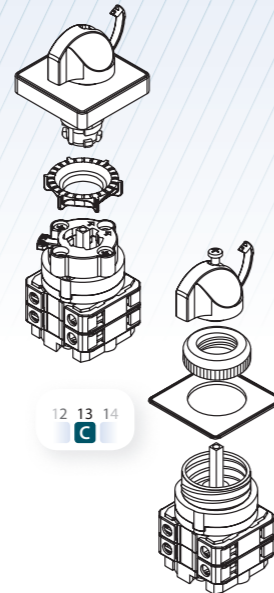
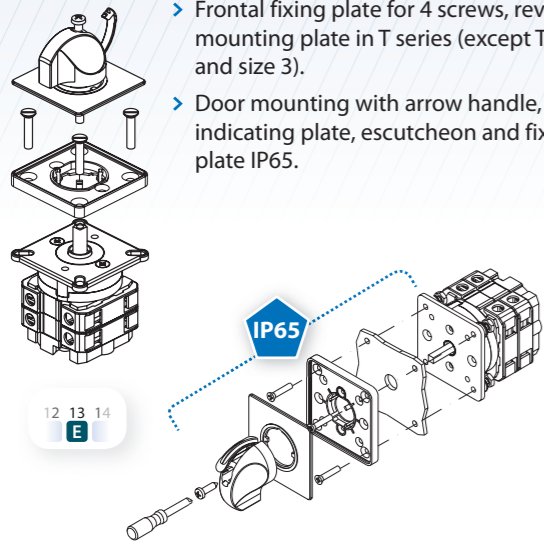

Central quick fixing $\varnothing 22$ | C type

For T - TB - TF series

- > Door mounting for $\varnothing 22$ mm available for sizes 0 and 1.
- > For arrow handle with indicator or padlockable handle.
- > Maximum number of chambers supported
Size 0 = 6
Size 1 = 4

Central fixing with metal nut $\varnothing 22$ | Z type

For T - TF series

- > Door mounting for metal nut $\varnothing 22$ mm available for sizes 0 and 1. (also $\varnothing 30$ mm under request).

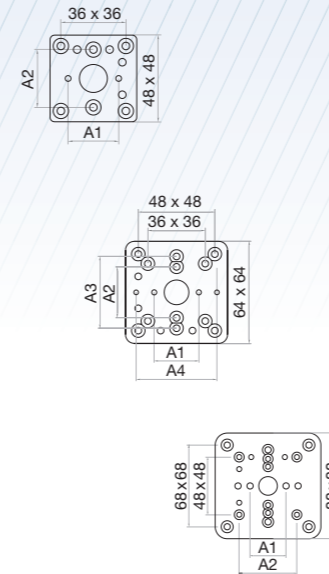

Size	Models		13
0	A1 = 28 mm	A2 = 32 mm	M
	A1 = 30 mm	A2 = 34 mm	N
1	A1 = 35 mm	A2 = 38 mm	O
	A1 = 28 mm	A2 = 32 mm	M
	A4 = 46 mm		
2	A1 = 33 mm	A2 = 30 mm	N
	A3 = 47 mm	A4 = 50 mm	P
	A1 = 32 mm	A2 = 32 mm	P
2	A1 = 38 mm	A3 = 40 mm	M
	A1 = 30 mm	A2 = 50 mm	P

Multi-distance fixing plates with screws

For T - TB - TF series

- > Multidrill plates for different fixing distances.
- > Fixing with two screws for mounting without base nor indicating plate.
- > Available for sizes 0 - 1 - 2. (size 0 also supports multi-fixing plate size 1).

Base mounting

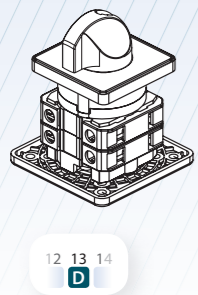

Base mounting by screws with direct handle | D type

For T series

- > Rear fixing plate for 4 screws, reversible mounting plate in T series (except T175 and size 3).

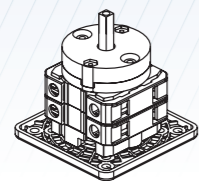

Base mounting by screws without plate nor handle | G type

For T series

- > Rear fixing plate for 4 screws, reversible mounting plate in T series (except T175 and size 3).

For TB - TF series

- > Fixed rear support plate as standard.
- > Serie TB for 4 screws.
- > Serie TF for two screws (also DIN rail).

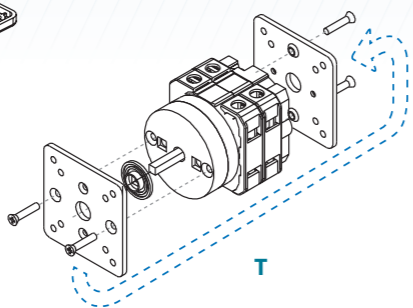

Base mounting with clutch device and door handle | F type

For T - TB - TF series

- > Rear fixing plate for 4 screws in T - TB series or two screws and DIN rail in TF series.
- > With clutch device and door lock, according to series and sizes.
- > The clutch device (D501) for size 0, if it is combined with other accessory, must be size 1.
- > The clutch device (D501) and shaft extension are supplied separately (as accessories) or incorporated with the cam switch (size 3 is always incorporated with the cam switch).
- > Specify useful depth of the space available when ordering.

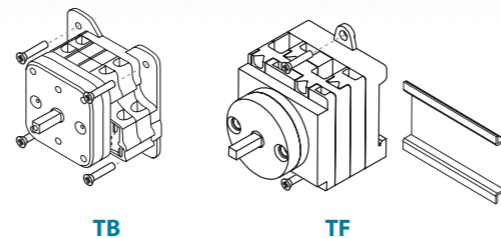

DIN rail mounting with direct handle | A type

For T series

- > Rear fixing support (D904) for T series sizes 0 and 1.
- > DIN rail is included in TF series.

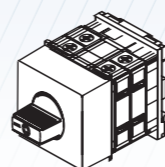

DIN rail mounting with modular handle | H type

For TF series

- > Rear fixing support and modular handle tape (D905) for T - TF series size 0.

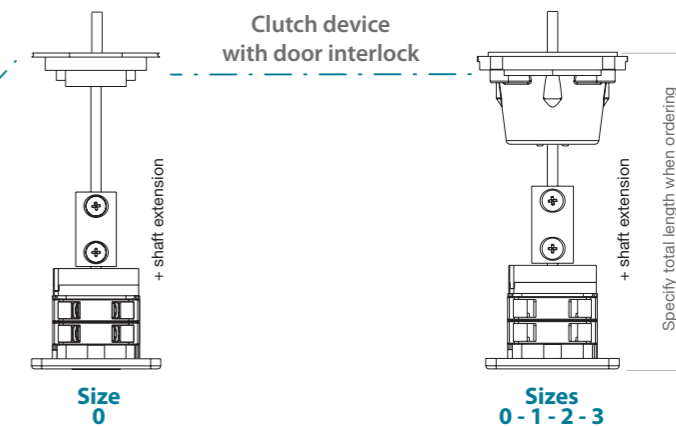
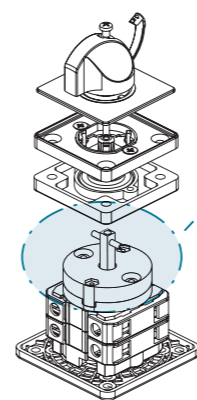



TP|TB|TF Standard diagrams

For many switching operations that can be resolved using cam switches, we have a number of standard schemes applicable to the most common applications in electrical installations, equipment, machinery, etc. If you do not find what you are looking for in this selection, or have a special switching requirement, you can use the blank diagrams form on the next page and send it to our sales department. The descriptive logic representing and interpreting the circuits are explained below.

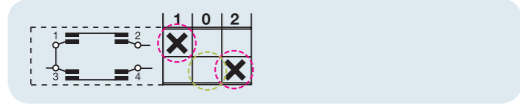

It represents "closed contact".

It represents "opened contact".

The contact 1/2 is closed in position 1 and opened in positions 0 & 2.

The contact 3/4 is closed in position 2 and opened in positions 0 & 1.

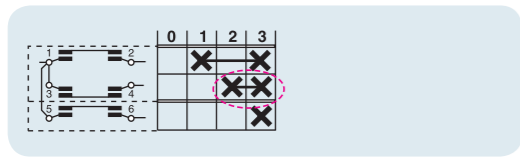

It represents closed contact "without interruption".

The contact 1/2 closes in position 1, and remains closed in position 2 & 3.

The contact 3/4 closes in position 2 and remains closed in position 3.

When passing from one position to another there is no contact interruption in any cases.

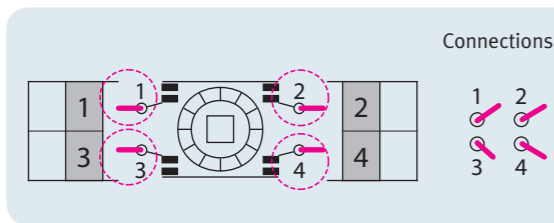

Connection point.

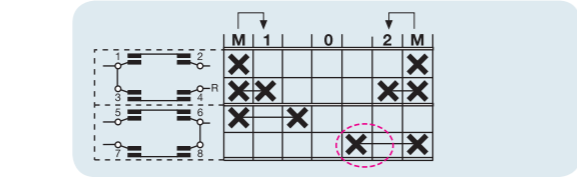

They represent "late break contact" or "early-make contact" in relation to others.

The contacts 5/6 & 7/8 close before the contacts 3/4 & 1/2 and they will also open after these contacts.

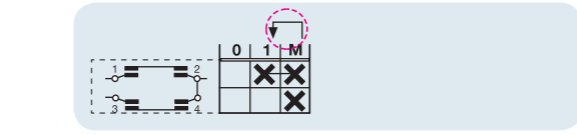

It represent "spring return" to previous position.

The M position is not fixed and it will return to position 1 when the handle is released.

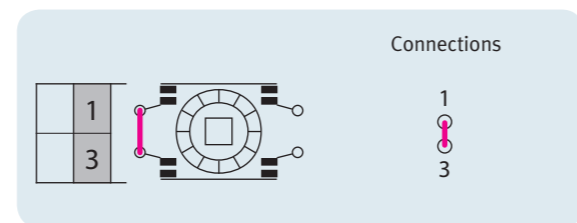

Vertical bridging link.

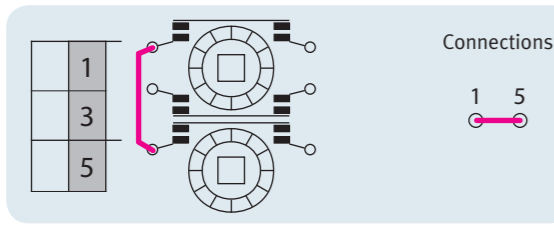

Horizontal bridging link.

Inscription plate
Name plate

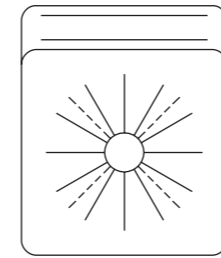

ORDER SHEET FOR NON-STANDARD CAM SWITCHES 10 TO 315 AMP.



Series

Code

- Contact closed
- Closed contact without interruption
- Late break contact
- Early-make contact
- Return from 30°

Rev.

Number of switch positions

1		2	
3		4	
5		6	
7		8	
9		10	
11		12	
13		14	
15		16	
17		18	
19		20	
21		22	
23		24	
25		26	
27		28	
29		30	
31		32	
33		34	
35		36	
37		38	
39		40	
41		42	
43		44	
45		46	
47		48	

Connections

1	5	9	13	17	21	25	29	33	37	41	45
0	0	0	0	0	0	0	0	0	0	0	0
3	7	11	15	19	23	27	31	35	39	43	47
46	42	38	34	30	26	22	18	14	10	6	2
0	0	0	0	0	0	0	0	0	0	0	0
0	0	0	0	0	0	0	0	0	0	0	0
48	44	40	36	32	28	24	20	16	12	8	4

T series

0	12	20				
1	16	25	32	40		
2	50	63	80	100	125	175
3	200	250	315			

TB series

20	25	32	40
----	----	----	----

TF series

12	16	25	32	40
----	----	----	----	----

TP series

10

Type

E	C	Z	D	G	H	F
---	---	---	---	---	---	---

Handle

Indicator arrow	Black	Shaft extension	mm
Ball lever handle	Red		
Double handle	Red		
Key	Yellow		

Nameplate

Aluminium colour	Normal
Yellow colour	With inscription
Switching angle 30° -45° -60° -90°	

Materials

Chambers

Notes

Validity

Date

Signature

Special devices

On-Off switches

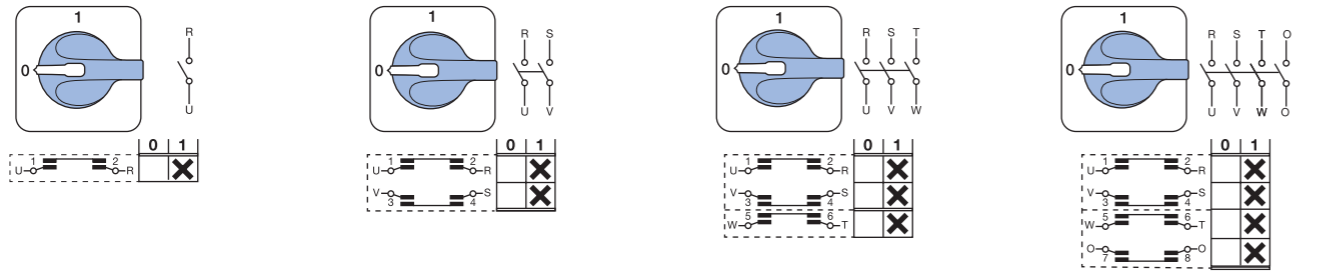

010 1 pole 1 chamber	010/5 5 poles	011 2 poles 1 chamber	010/10 10 poles	012 3 poles 2 chambers	010/15 15 poles	013 4 poles 2 chambers	010/20 20 poles
010/6 6 poles	010/11 11 poles	010/12 12 poles	010/16 16 poles	010/17 17 poles	010/21 21 poles	010/22 22 poles	010/24 24 poles
010/7 7 poles	010/13 13 poles	010/14 14 poles	010/19 19 poles				

To view these wiring diagrams please visit our download area on www.telergon.com

On-Off switches with contacts leading when making

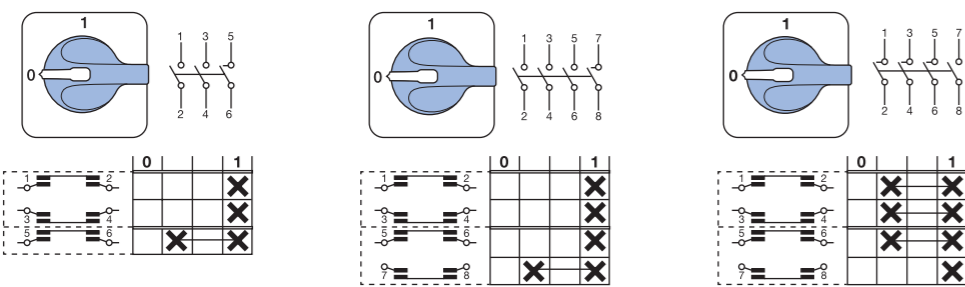

020 3 poles 1 preclosed pole 2 chambers	021 4 poles 1 preclosed pole 2 chambers	022 4 poles 3 preclosed poles 2 chambers
---	---	--

Reversing switches

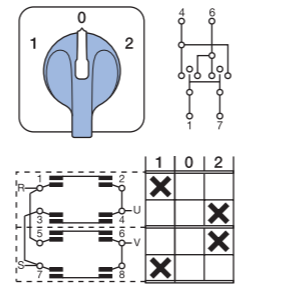

101 2 poles 2 chambers

Reversing switches

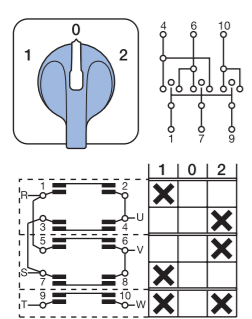

102 3 poles 3 chambers

Reversing switches with spring return

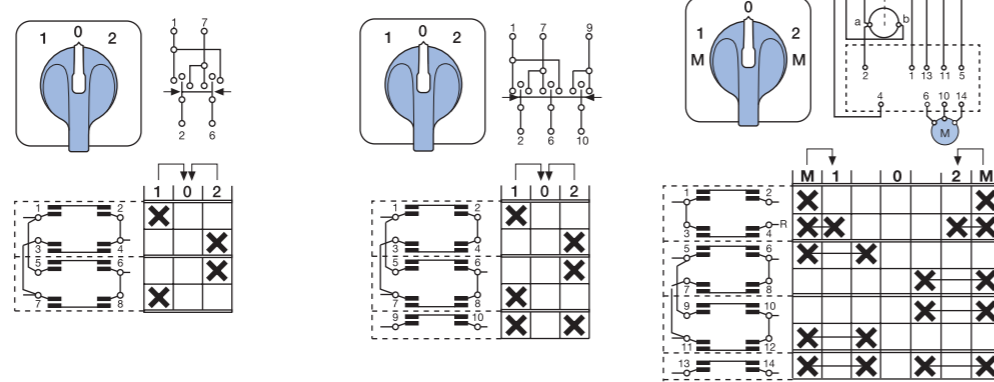

111 2 poles 2 chambers	112 3 poles 3 chambers	113 3 poles for use with reserving contactors 4 chambers
------------------------------	------------------------------	---

Control switches with spring return

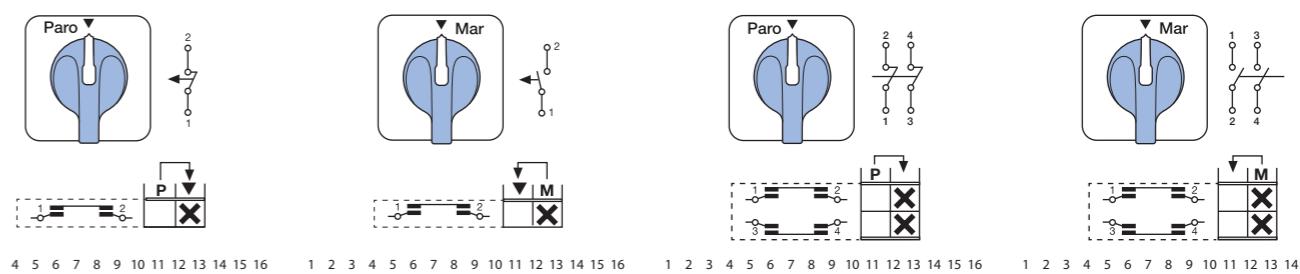

201 Start switch 1 pole 1 chamber	202 Stop switch 1 pole 1 chamber	203 Start switch 2 poles 1 chamber	204 Stop switch 2 poles 1 chamber
---	--	--	---

Stop-Start switches

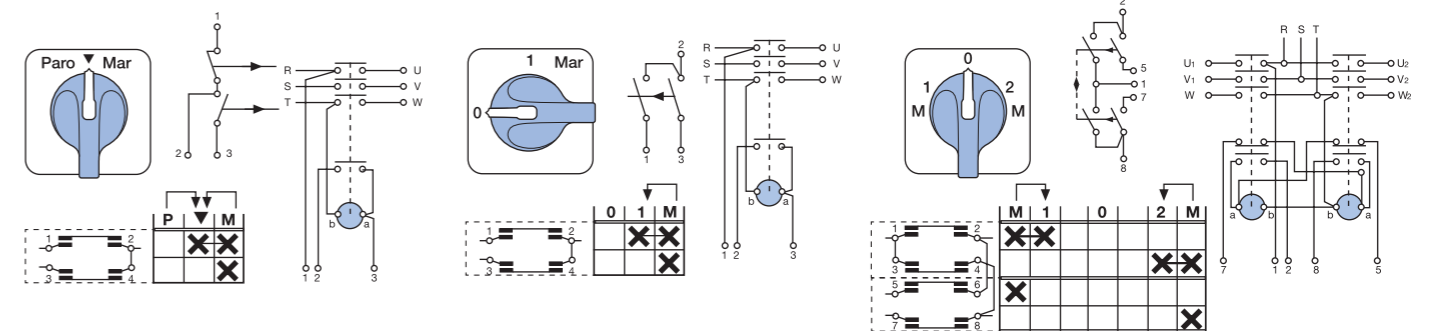

205 With contactor 1 chamber	206 With contactor and spring return 1 chamber	207 With spring return to run for 2 units 2 chambers
------------------------------------	--	--

Start delta switches

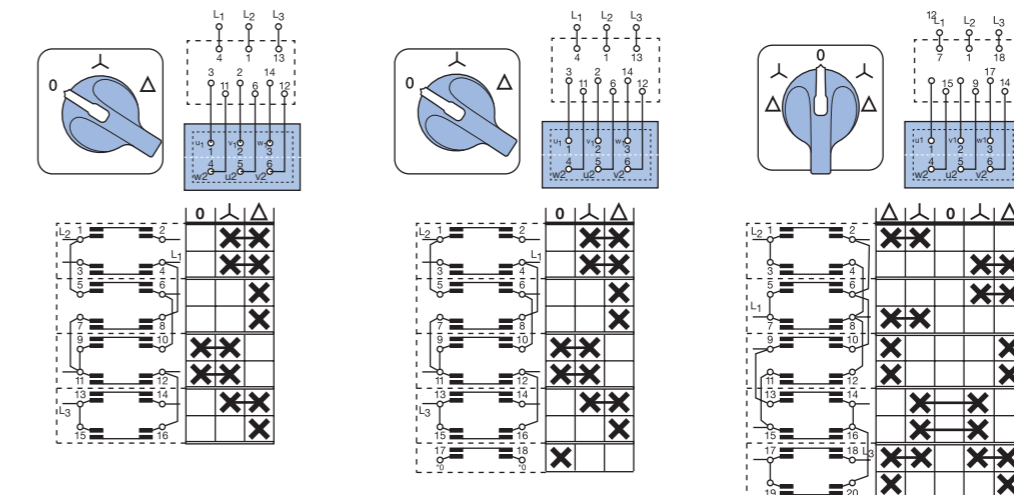

300 Normal type 4 chambers	301 Auxiliary contact closed in "0" 5 chambers	302 Reversing 5 chambers
----------------------------------	--	--------------------------------

- 303
Rotary
0 - λ - Δ - 0 - λ - Δ - 0
5 chambers
- 304
Position λ return to 0
0 - λ - Δ
4 chambers
- 305
Reversing. Return from λ to 0
Δ - λ - 0 - λ - Δ
5 chambers
- 308
Use with contactor
0 - λ - Δ
4 chambers
- 309
Reversing for use with contactor
Δ - λ - 0 - λ - Δ
7 chambers

To view these wiring diagrams please visit our download area on www.telergon.com

Start delta switches

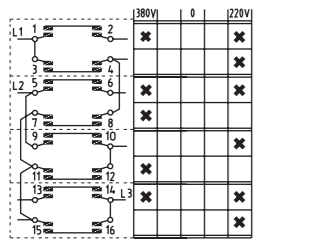
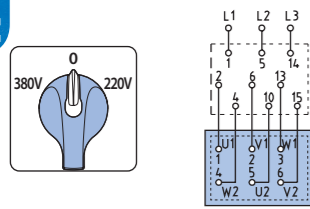

1 2 3 4 5 6 7 8 9 10 11 12 13 14 15 16
00310
310
 Selector $\lambda - \Delta$
 380 - 0 - 220
 4 chambers

Split phase starting switches

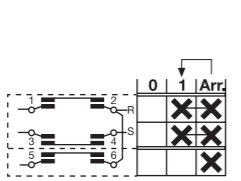
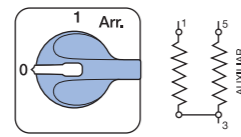

1 2 3 4 5 6 7 8 9 10 11 12 13 14 15 16
00315
315
 Start return to 1
 2 chambers

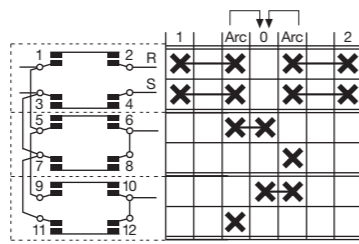
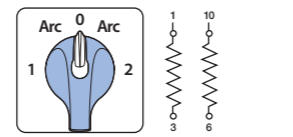

1 2 3 4 5 6 7 8 9 10 11 12 13 14 15 16
00316
316
 Reversing type of T315
 1 - ARR - 0 - ARR - 2
 3 chambers

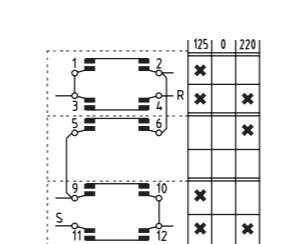
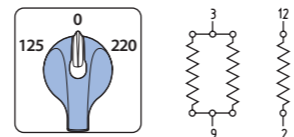

1 2 3 4 5 6 7 8 9 10 11 12 13 14 15 16
00317
317
 Start single phase 2 voltages
 3 chambers

Dahlander multi-step switches

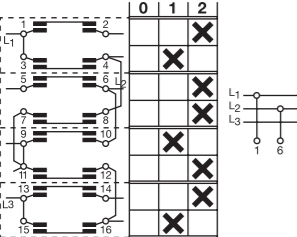
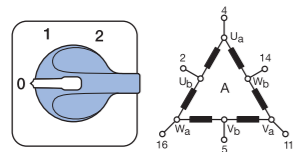

1 2 3 4 5 6 7 8 9 10 11 12 13 14 15 16
00330
330
 Dahlander 0 - $\Delta_A - \lambda \lambda_A$
 4 chambers

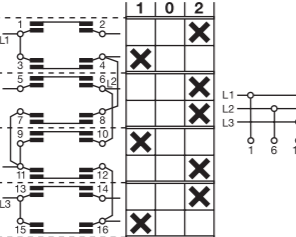
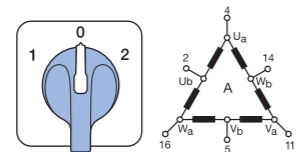

1 2 3 4 5 6 7 8 9 10 11 12 13 14 15 16
00331
331
 Dahlander $\Delta_A - 0 - \lambda \lambda_A$
 4 chambers

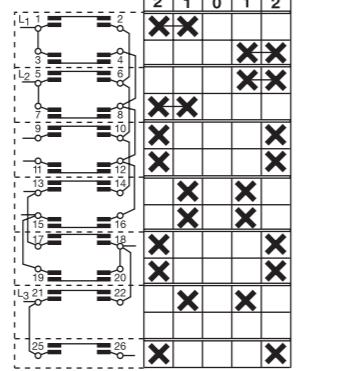
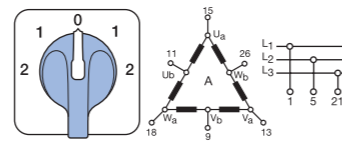

1 2 3 4 5 6 7 8 9 10 11 12 13 14 15 16
00332
332
 Reversing type of T330
 7 chambers

333
 Dahlander 0 - $\Delta_A - \lambda \lambda_A - 0 - \Delta_A - \lambda \lambda_A - 0$
 0 - 1 - 2 - 0 - 1 - 2
 5 chambers

334
 For use with contactor
 0 - 1 - 2
 5 chambers

335
 Selector Dahlander
 0 - $\lambda - \Delta_A - \lambda \lambda_A$
 6 chambers

336
 Reversing Dahlander
 $\lambda \lambda_A - \Delta_A - \lambda - 0 - \lambda - \Delta_A - \lambda \lambda_A$
 2 - 1 - $\lambda - 0 - \lambda - 1 - 2$
 8 chambers

To view these wiring diagrams please visit our download area on www.telergon.com

Separate winding to speed

340
 0 - $\lambda_A - \Delta - \lambda_B$
 0 - $\lambda - 1 - 2$
 6 chambers

341
 0 - $\Delta_A - \lambda_B$
 0 - 1 - 2
 4 chambers

342
 0 - A - B en λ or Δ
 0 - 1 - 2
 3 chambers

343
 Reversing del 342
 2 - 1 - 0 - 1 - 2
 5 chambers

344
 $\Delta_B - \lambda_B - 0 - \lambda_A - \Delta_A$
 1 - $\lambda - 0 - \lambda - 2$
 8 chambers

350
 0 - $\lambda_A - \Delta_B - \lambda \lambda_B$
 0 - 1 - 2 - 3
 6 chambers

351
 Reversing type of T350
 3 - 2 - 1 - 0 - 1 - 2 - 3
 9 chambers

To view these wiring diagrams please visit our download area on www.telergon.com

Changeover switches with center "Off"

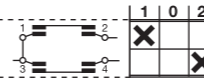
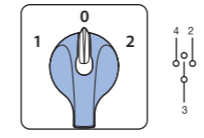

1 2 3 4 5 6 7 8 9 10 11 12 13 14 15 16
00400
400
 1 pole
 1 chamber

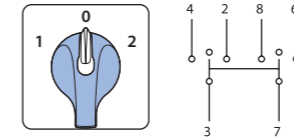

1 2 3 4 5 6 7 8 9 10 11 12 13 14 15 16
00401
401
 2 poles
 2 chambers

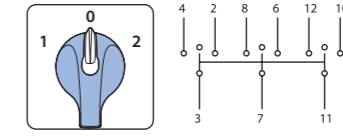

1 2 3 4 5 6 7 8 9 10 11 12 13 14 15 16
00402
402
 3 poles
 3 chambers

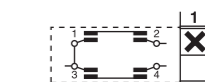
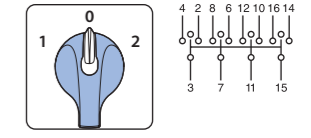

1 2 3 4 5 6 7 8 9 10 11 12 13 14 15 16
00403
403
 4 poles
 4 chambers

	Poles	Positions	Chambers		Poles	Positions	Chambers		Poles	Positions	Chambers		Poles	Positions	Chambers
400/5	5	3	5	400/7	7	3	7	400/9	9	3	9	400/11	11	3	11
400/6	6	3	6	400/8	8	3	8	400/10	10	3	10	400/12	12	3	12

To view these wiring diagrams please visit our download area on www.telergon.com

Changeover switches with spring return to center

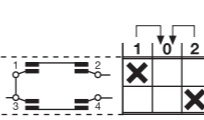
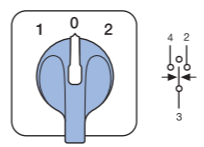

1 2 3 4 5 6 7 8 9 10 11 12 13 14 15 16
00405
405
 1 pole
 1 chamber

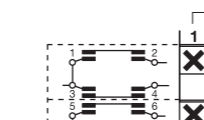
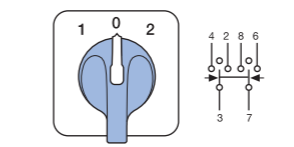

1 2 3 4 5 6 7 8 9 10 11 12 13 14 15 16
00406
406
 2 poles
 2 chambers

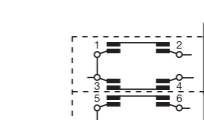
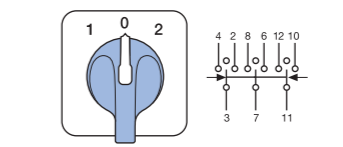

1 2 3 4 5 6 7 8 9 10 11 12 13 14 15 16
00407
407
 3 poles
 3 chambers

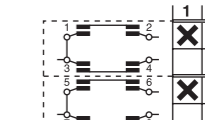
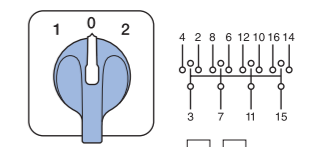

1 2 3 4 5 6 7 8 9 10 11 12 13 14 15 16
00408
408
 4 poles
 4 chambers

Multi-step switches with "Off" position

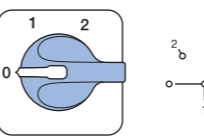

1 2 3 4 5 6 7 8 9 10 11 12 13 14 15 16
00410
410
 1 pole 2 positions
 1 chamber

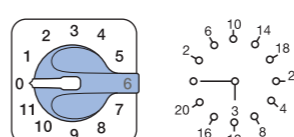

1 2 3 4 5 6 7 8 9 10 11 12 13 14 15 16
00419
419
 1 pole 11 positions
 6 chambers

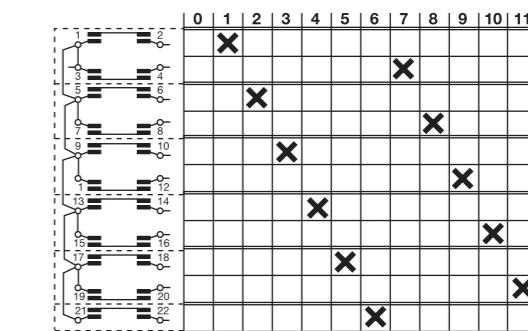

Multi-step switches with "Off" position

	Poles	Positions	Chambers		Poles	Positions	Chambers		Poles	Positions	Chambers		Poles	Positions	Chambers
411	1	3	2	422	2	4	4	432	3	4	6	452	5	4	10
412	1	4	2	423	2	5	5	433	3	5	9	460	6	2	6
413	1	5	3	424	2	6	7	434	3	6	12	461	6	3	9
414	1	6	4	425	2	7	8	435	3	7	12	462	6	4	12
415	1	7	4	426	2	8	9	440	4	2	4	470	7	2	7
416	1	8	5	427	2	9	10	441	4	3	6	471	7	3	11
417	1	9	5	428	2	10	11	442	4	4	8	480	8	2	8
418	1	10	6	429	2	11	12	443	4	5	10	481	8	3	12
420	2	2	2	430	3	2	3	450	5	2	5	490	9	2	9
421	2	3	3	431	3	3	5	451	5	3	8				

To view these wiring diagrams please visit our download area on www.telergon.com

Changeover switches without "Off"

500
1 pole
1 chamber

501
2 poles
2 chambers

502
3 poles
3 chambers

503
4 poles
4 chambers

	Poles	Positions	Chambers		Poles	Positions	Chambers		Poles	Positions	Chambers		Poles	Positions	Chambers
500/5	5	2	5	500/7	7	2	7	500/9	9	2	9	500/11	11	2	11
500/6	6	2	6	500/8	8	2	8	500/10	10	2	10	500/12	12	2	12

To view these wiring diagrams please visit our download area on www.telergon.com

Multi-step switches without "Off" position

510
1 pole 3 positions
2 chambers

519
1 pole 12 positions
6 chambers

Multi-step switches without "Off" position

	Poles	Positions	Chambers		Poles	Positions	Chambers		Poles	Positions	Chambers		Poles	Positions	Chambers
511	1	4	2	521	2	4	4	530	3	3	5	543	4	6	12
512	1	5	3	522	2	5	5	531	3	4	6	550	5	3	8
513	1	6	3	523	2	6	6	532	3	5	8	551	5	4	10
514	1	7	4	524	2	7	7	533	3	6	9	552	5	5	13
515	1	8	4	525	2	8	8	534	3	7	11	560	6	3	9
516	1	9	5	526	2	9	9	535	3	8	12	561	6	4	12
517	1	10	5	527	2	10	10	540	4	3	6	570	7	3	11
518	1	11	6	528	2	11	11	541	4	4	8	580	8	3	12
520	2	3	3	529	2	12	12	542	4	5	10				

To view these wiring diagrams please visit our download area on www.telergon.com

Gang switches

601
1 pole switching sequence
0 - A - (A+B)
1 chamber

602
2 poles switching sequence
0 - A - (A+B)
2 chambers

603
1 pole switching sequence
0 - A - B - (A+B)
1 chamber

604
2 poles switching sequence
0 - A - B - (A+B)
2 chambers

605
1 pole switching sequence
0 - A - (A+B) - (A+B+C)
2 chambers

606
2 poles switching sequence
0 - A - (A+B) - (A+B+C)
3 chambers

607
3 poles switching sequence
0 - A - (A+B)
3 chambers

608
3 poles switching sequence
0 - A - B - (A+B)
3 chambers

Gang switches

609
3 poles switching sequence
0 - A - (A+B) - (A+B+C)
5 chambers

610
Switching sequence
λ 0 - A - (A+B) - (A+B+C)
2 chambers

611
Switching sequence
Δ 0 - A - (A+B) - (A+B+C)
2 chambers

612
Switching sequence 0 - A + B series
A - B - (A + B) paralell
2 chambers

626
3 phases, 6 points
5 chambers

630
Switching sequence
0 - A - (A+B) - (A+B+C)
2 chambers

631
Switching sequence
0 - A - (A+B) - (A+B+C) - (A+B+C+D)
2 chambers

632
Switching sequence
0 - A - (A+B) - (A+B+C) - (A+B+C+D) - (A+B+C+D+E)
3 chambers

Voltmeter switches

Kitchen and heating switches

613
3 positions switching sequence
0-A+B paralell; A or B-A+B series -0
3 chambers

614
3 positions switching sequence
0-A+B series; A or B-A+B paralell
2 chambers

700
2 phases C.A. or 2 poles C.C.
2 chambers

701
3 phases
2 chambers

702
3 phases to neutral
2 chambers

704
3 phases and 1 phase to neutral
3 chambers

Resistance elimination switches

620
3 phases, 3 points
2 chambers

621
3 phases, 3 points
3 chambers
With auxiliary contact

622
3 phases, 4 points
3 chambers

624
3 phases, 5 points
4 chambers

705
3 phases to phase and 3 phases to neutral
3 chambers

706
2 three-phase lines (phase to phase)
4 chambers/chambers

703
4 lines with 2 wires C.A. o C.C.
4 chambers

708
3 phases, 2 potencial transformers
1 pole
2 chambers

To view these wiring diagrams please visit our download area on www.telergon.com

Ammeter switches

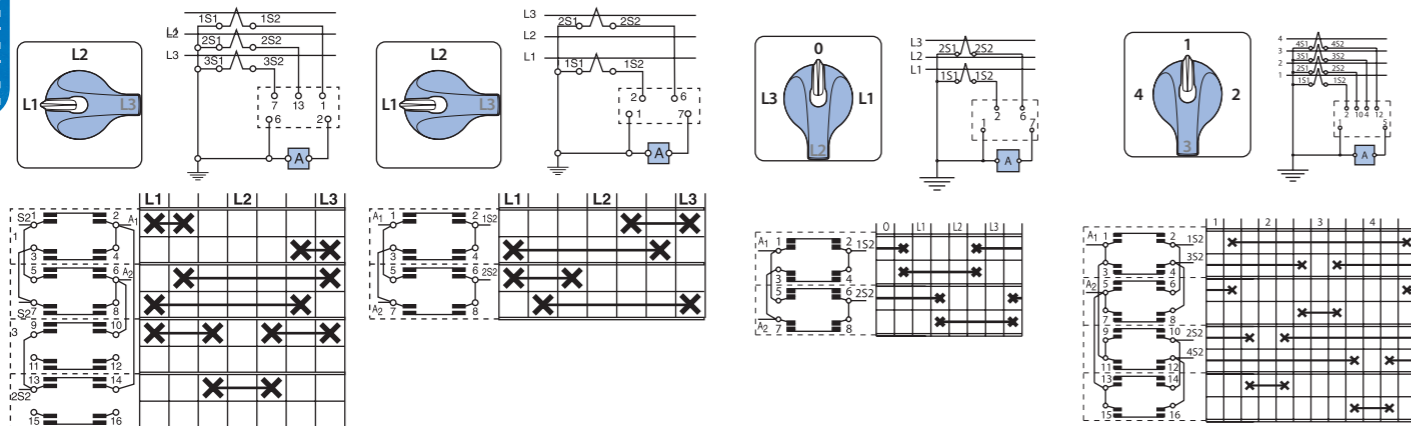

720* 3 phases, 3 current transformers, 1 pole, 4 chambers
721 3 phases, 2 current transformers, 1 pole, 2 chambers
724 3 phases, 2 current transformers, 1 pole, 2 chambers
725 4 lines, 4 current transformers, 1 pole, 4 chambers

*New diagram 732

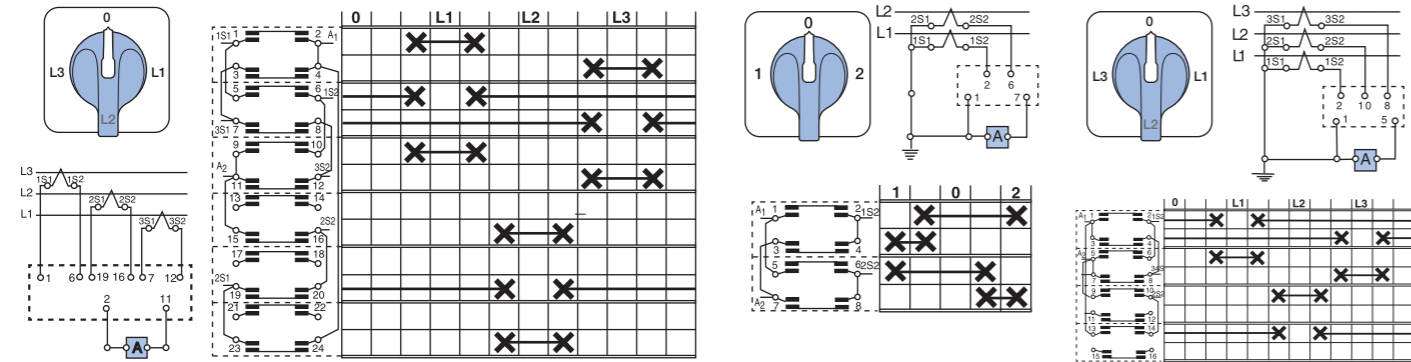

727 3 lines, 3 current transformers, 2 poles, 6 chambers
730 2 current transformers, 1 pole, 2 chambers
731* 3 current transformers, 1 pole, 4 chambers

*New diagram 733

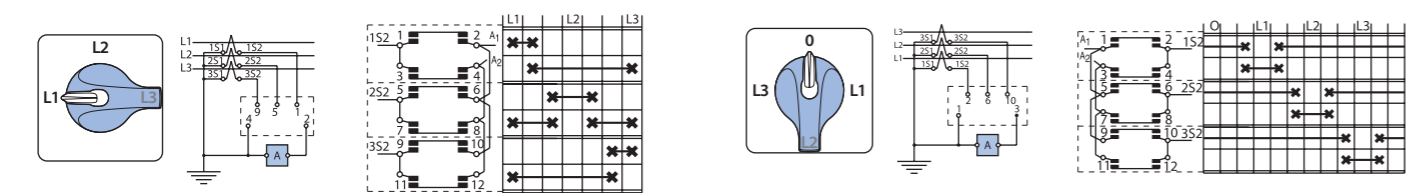

732 3 phases, 3 current transformers, 1 pole, 3 chambers
733 3 lines, 3 current transformers, 1 pole, 3 chambers

722 3 phases, 2 or 3 current transformers, 1 pole, 5 chambers
723 2 lines, 2 current transformers, 1 pole, 3 chambers
729 1 current transformers, 1 pole, 1 chamber
726 2 lines, 2 current transformers, 2 poles, 3 chambers
728 4 lines, 4 current transformers, 2 poles, 6 chambers

To view these wiring diagrams please visit our download area on www.telergon.com

Switches for B.C.D. codification with "Off"

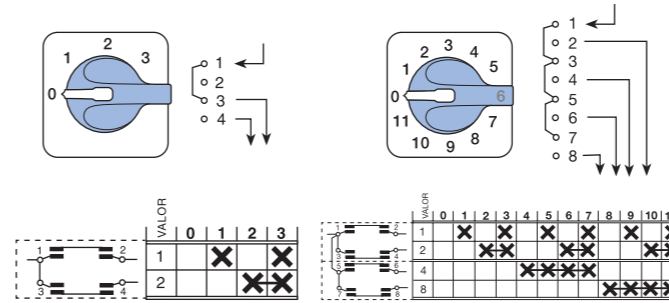

0BCD3 3 positions, 1 chamber
0BCD11 11 positions, 2 chambers
0BCD4 4 positions, 2 chambers
0BCD6 6 positions, 2 chambers
0BCD8 8 positions, 2 chambers
0BCD10 10 positions, 2 chambers
0BCD5 5 positions, 2 chambers
0BCD7 7 positions, 2 chambers
0BCD9 9 positions, 2 chambers

Switches for B.C.D. codification without "Off"

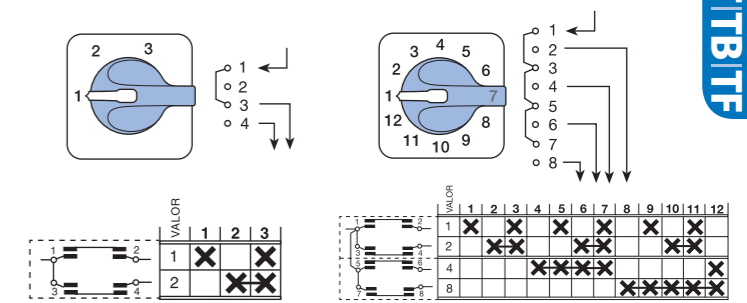

1BCD3 3 positions, 1 chamber
1BCD12 12 positions, 2 chambers
1BCD4 4 positions, 2 chambers
1BCD6 6 positions, 2 chambers
1BCD8 8 positions, 2 chambers
1BCD10 10 positions, 2 chambers
1BCD5 5 positions, 2 chambers
1BCD7 7 positions, 2 chambers
1BCD9 9 positions, 2 chambers
1BCD11 11 positions, 2 chambers

To view these wiring diagrams please visit our download area on www.telergon.com

By-pass switches

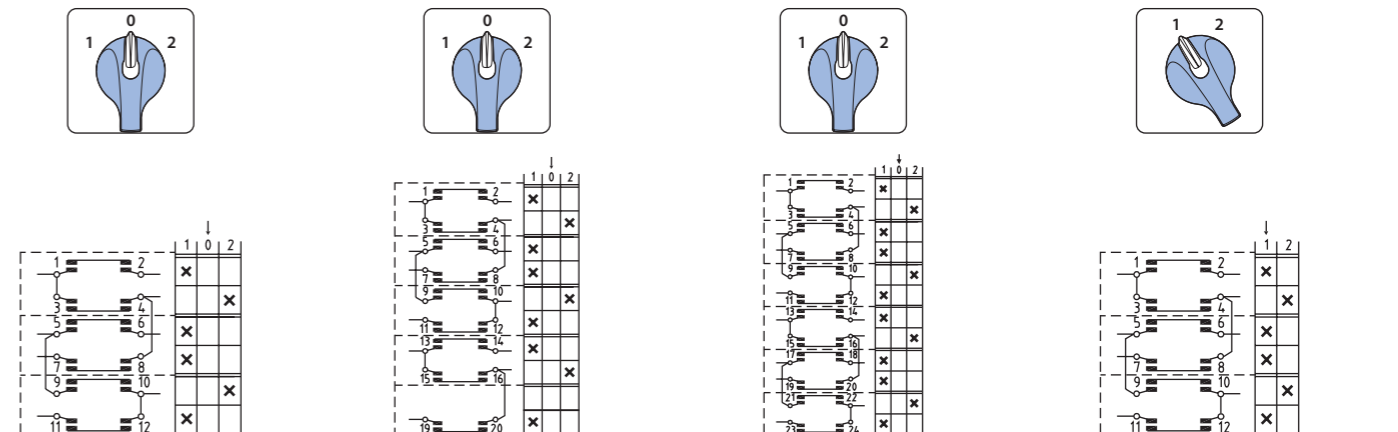

800 2 poles, 3 chambers
801 3 poles, 5 chambers
802 3 poles + N, 6 chambers
820 2 poles, 3 chambers

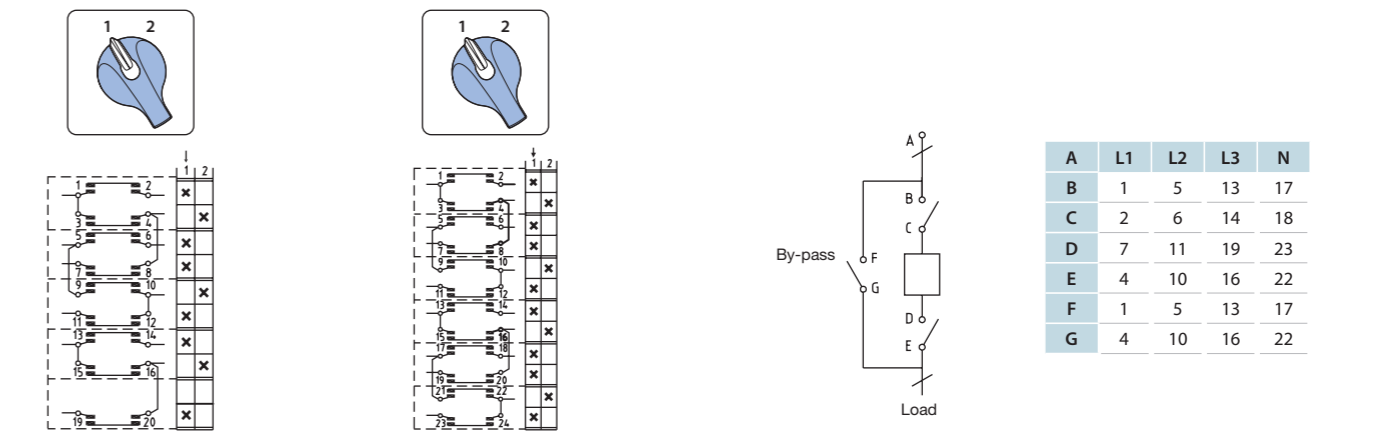

821 3 poles, 5 chambers
822 3 poles + N, 6 chambers

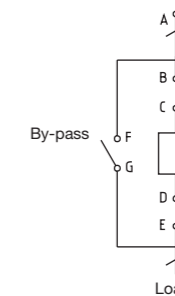

A	L1	L2	L3	N
B	1	5	13	17
C	2	6	14	18
D	7	11	19	23
E	4	10	16	22
F	1	5	13	17
G	4	10	16	22



T Door mounting

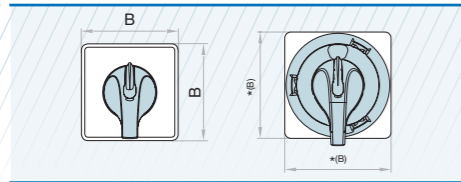

Door mounting drilling

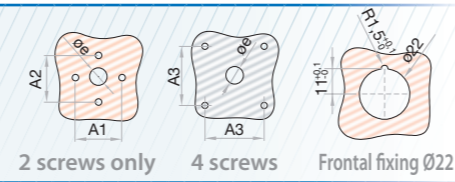

*B) Features & dimensions in page 27.

Note:
The cam switches allow a construction up to 12 chambers (24 contacts).
It's necessary to distribute in several columns (maximum three of 12 chambers each) when the number of contacts is higher than 24, so we use the tandem drives D200 or D201.
Depending on the number of contacts to be switched simultaneously, it's possible to supply up to 14 chambers switches in size 0.

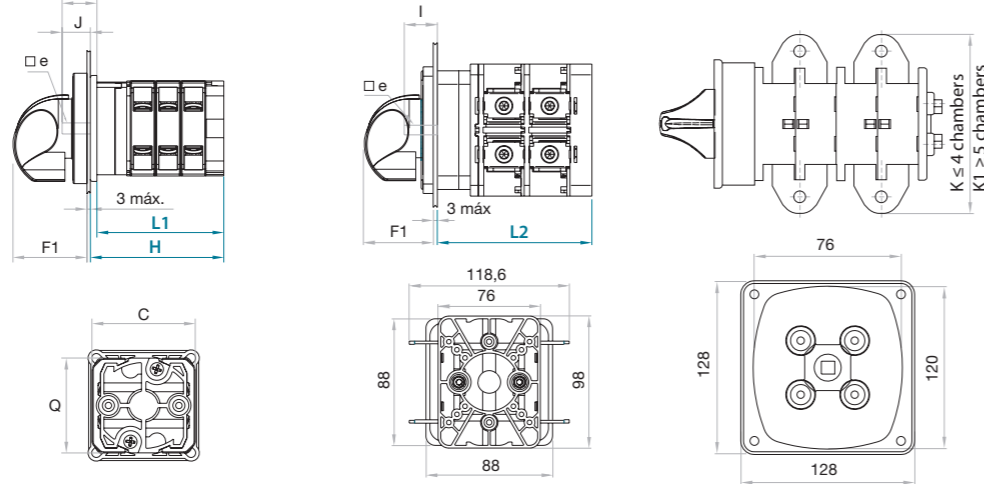

Size	Series	A1	øA1	A2	øA2	A3	øA3	B	C	øe	□e	Q	F1	I	J	K	K1
0	T12 T20	32	4,5	-	ø4,5	36	4,5	50	46,5	12	5	46	33,5	18	15	-	-
1	T16 T25 T32 T40	45	4,5	-	ø4,5	48	4,5	65	60,5	12	5	57,5 64,5	36	20	16,8	-	-
2	T50 T63 T80 T100 T125 T175	-	-	60	5,5	68	5,5	94	66 84,5	12	7	80 89	45	24,5	20,5	-	-
3	T200 T250 T315 T400 T500 T630 T800	-	-	-	-	108	6,5	128	76	16	10	120	67	-	40	150 176 218	- - 256

Size	Series	Chambers														
		1□	2□	3□	4□	5□	6□	7□	8□	9□	10□	11□	12□	13□	14□	
0	T12 T20	L1	34,5	46	57,5	69	80,5	92	103,5	115	126,5	138	149,5	161	172,5	184
		H	37,5	49	60,5	72	83,5	95	106,5	118	129,5	141	152,5	164	175,5	187
1	T16 T25 T32 T40	L1	46,4	60,6	74,8	89	103,2	117,4	131,6	145,8	160	174,2	188,4	202,6	*(1)	*(1)
		H	49,6	63,8	78	92,2	106,4	120,6	134,8	149	163,2	177,4	191,6	205,8	*(1)	*(1)
2	T50 T63 T80 T100 T125 T175	L1	49,8	67,3	84,8	102,3	119,8	137,3	154,8	172,3	189,8	207,3	224,8	242,3	*(1)	*(1)
		H	53	70,5	88	105,5	123	140,5	158	175,5	193	210,5	228	245,5	*(1)	*(1)
3	T200 T250 T315 T400 T500 T630 T800	L1	58,5	78,5	98,5	118,5	138,5	158,5	178,5	198,5	218,5	238,5	258,5	278,5	*(1)	*(1)
		H	62,5	82,5	102,5	122,5	142,5	162,5	182,5	202,5	222,5	242,5	262,5	282,5	*(1)	*(1)

*(1) Tandem drive D200/D201 - Features & dimensions in page 24.

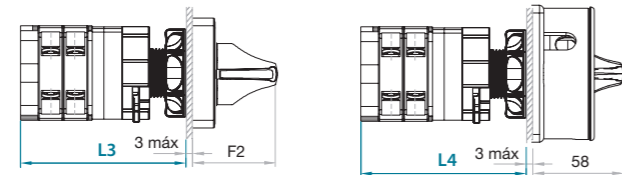

Size	Series	Chambers *(ch)							F2
		1□	2□	3□	4□	5□	6□	F2	
0	T12 T20	L3	63,5	75	86,5	98	109,5	121	53,5
1	T16 T25 T32 T40	L4	75,5	89,5	103,8	118	-	-	55,5
		L4	78,8	96,3	116,8	131,3	-	-	55,5

*(ch) Central quick fixing ø22 - maximum number of chambers supported.

TB Door mounting

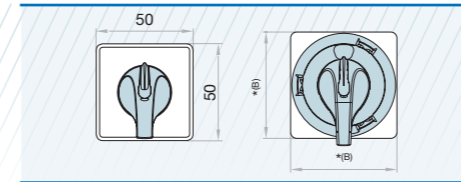

Door mounting drilling

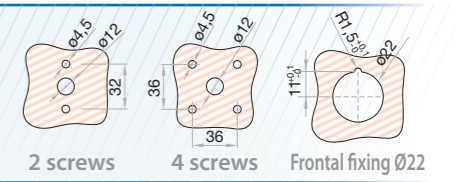

*B) Features & dimensions in page 27.

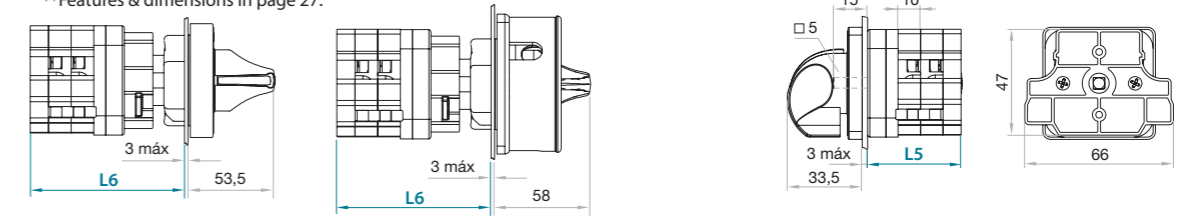

		Chambers											
L5	L6	1□	2□	3□	4□	5□	6□	7□	8□	9□	10□	11□	12□
		31,5	41,5	51,5	61,5	71,5	81,5	91,5	101,5	111,5	121,5	131,5	141,5
		60,5	70,5	80,5	90,5	100,5	110,5	-	-	-	-	-	-

TF Door mounting

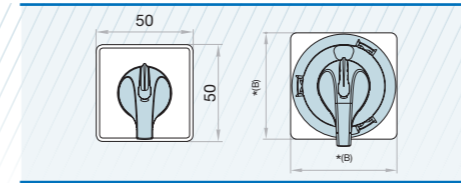

Door mounting drilling

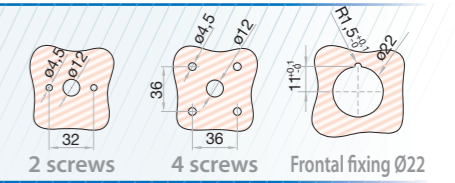

*B) Features & dimensions in page 27.

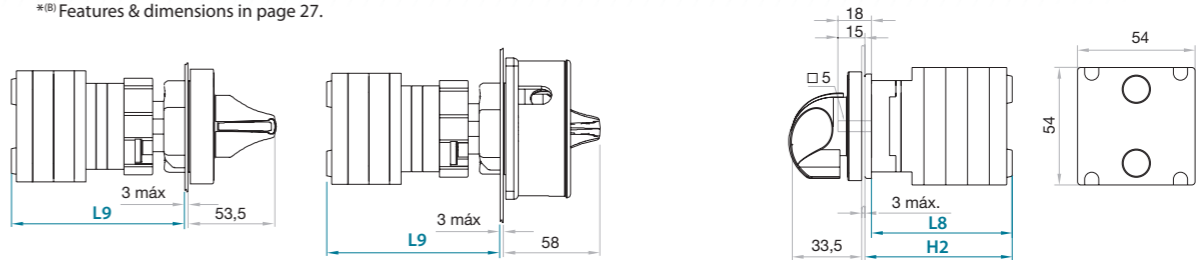

		Chambers												
L8	L9	H2	1□	2□	3□	4□	5□	6□	7□	8□	9□	10□	11□	12□
			45	55	65	75	85	95	105	115	125	135	145	155
			73,5	83,5	93,5	103,5	113,5	123,5	-	-	-	-	-	-
			48	58	68	78	88	98	108	118	128	138	148	158

TP Door mounting

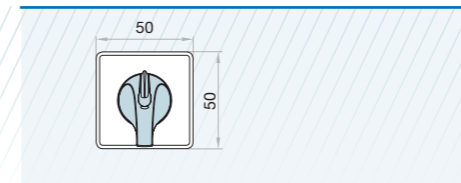

Door mounting drilling

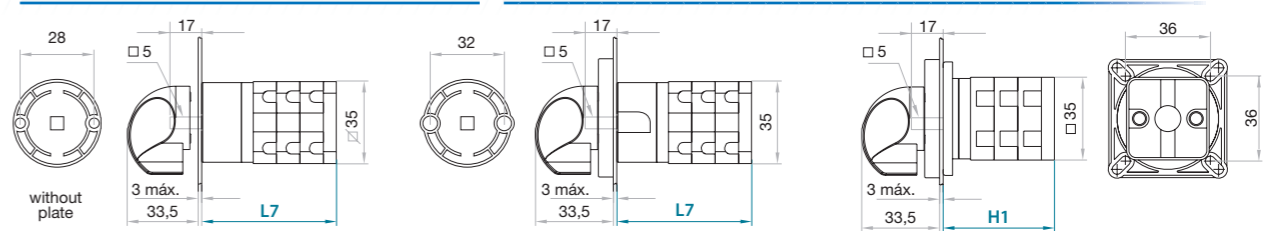
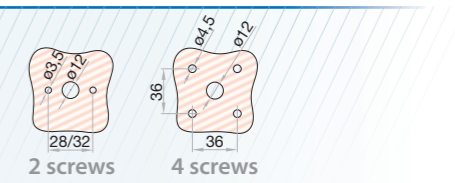

		Chambers											
L7	H1	1□	2□	3□	4□	5□	6□	7□	8□	9□	10□	11□	12□
		37,5	47	56,5	66	75,5	85	94,5	104	113,5	123	132,5	142
		26,5	36	45,5	55	64,5	74	83,5	93	102,5	112	121,5	131

T Base mounting with clutch device

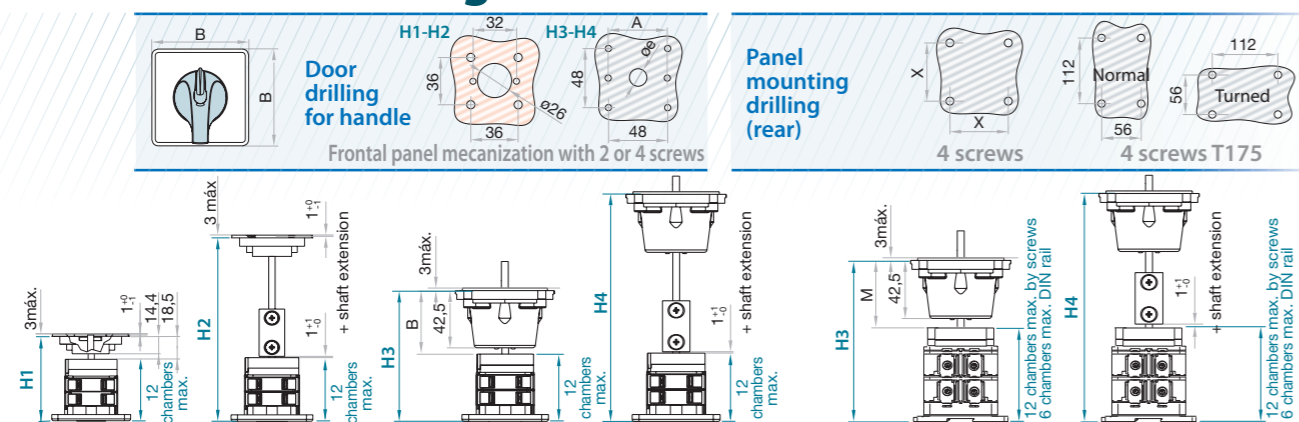

Size	Series	min max	Chambers				A	B	oe	M	X	
			H1	H2	H3	H4						
0	T12 T20	min	56	+11,5	94	+11,5	121	32	50	12	45,5	43
		max	-	-	256	-	283	-	-	-	-	-
1	T16 T25	min	-	-	-	+14,2	135,1	32	65	12	47,5	48
		max	-	-	-	-	297,1	-	-	-	-	-
1	T32 T40	min	-	-	-	+17,5	138,5	32	65	12	47,5	48
		max	-	-	-	-	300,5	-	-	-	-	-
2	T50 T63 T80	min	-	-	-	+20	152,5	60	94	12	52	68
		max	-	-	-	-	314,5	-	-	-	-	-
2	T100 T125	min	-	-	-	+27	161	60	94	12	52	68
		max	-	-	-	-	323	-	-	-	-	-
2	T175	min	-	-	-	+34	179,8	60	94	12	52	-
		max	-	-	-	-	341,8	-	-	-	-	-
3	T200	-	-	-	+40	-	48	16	67,5	108	-	

TB Base mounting with clutch device

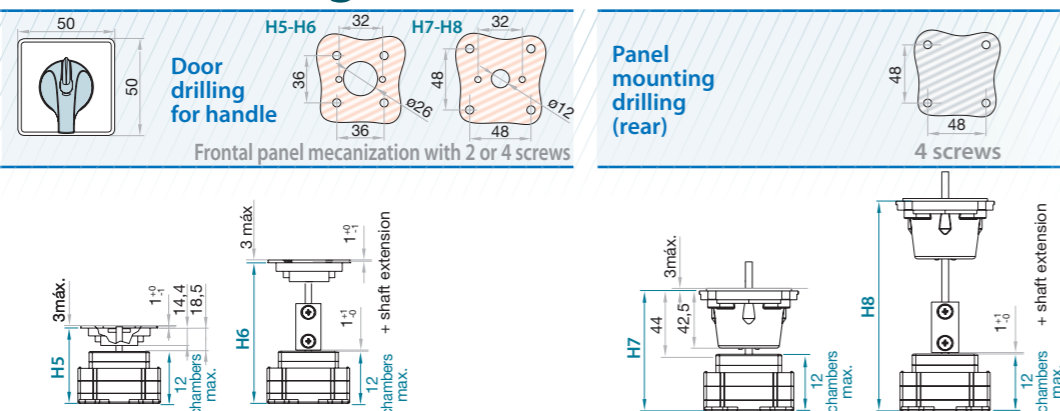

Size	Series	min max	Chambers			
			H5	H6	H7	H8
0	TB20 TB25 TB32	min	46	+10	84	+10
		max	-	-	246	-
1	TB50 TB63 TB80	min	75,5	+10	113	+10
		max	-	-	275,5	-

TF Base mounting with clutch device

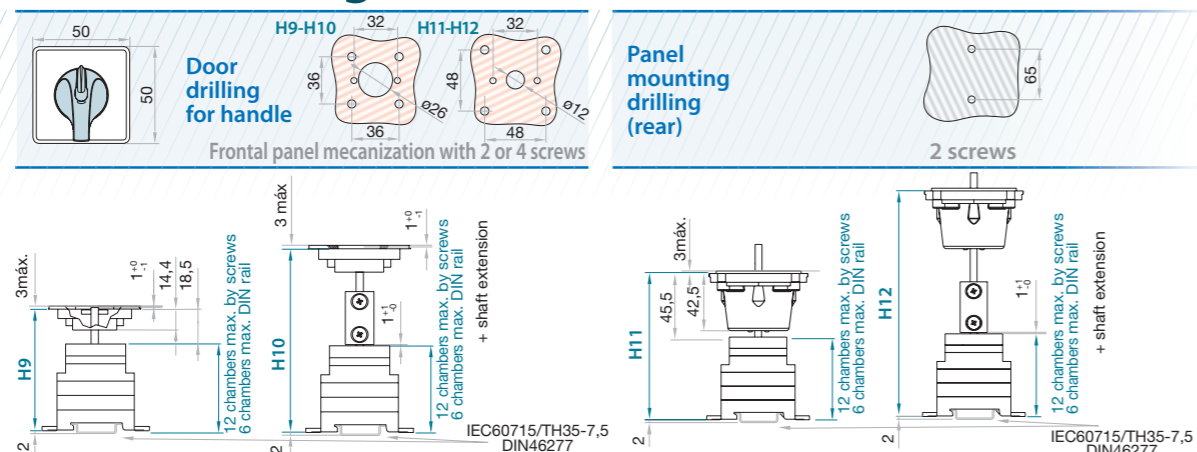

Size	Series	min max	Chambers			
			H9	H10	H11	H12
0	TF12 TF16 TF25	min	65,5	+10	103,5	+10
		max	-	-	265,5	-
1	TF32 TF40	min	92,5	+10	130,5	+10
		max	-	-	292,5	-

T Base mounting with screws or DIN rail (direct handle)

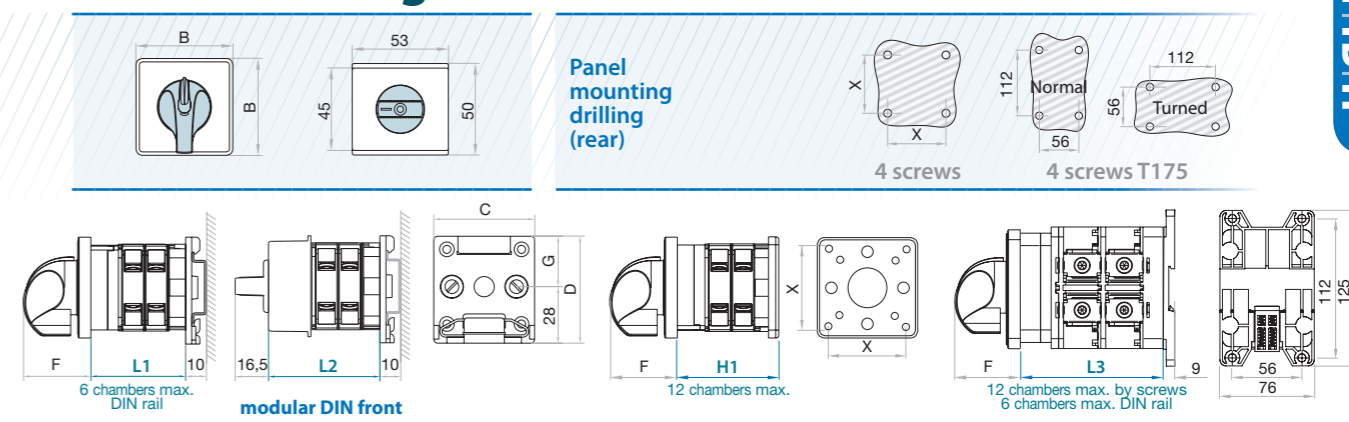

Size	Series	min max	Chambers						B	C	D	F	G	X	
			1	2	3	4	5	6							
0	T12 T20	min	34,5	46	57,5	69	80,5	92	50	50	53	33,5	25	-	-
		max	-	53,5	65	76,5 ^(*)	-	-	+11,5	-	50	53	-	25	-
1	T16 T25	min	37,5	49	60,5	72	83,5	95	50	-	-	33,5	-	43	
		max	46,4	60,6	74,8	89	-	-	+14,2	65	50	53	36	25	-
1	T32 T40	min	49,6	63,8	78	92,2	106,4	120,6	65	-	-	36	-	48	
		max	49,8	67,3	84,8	102,3	-	-	+17,5	65	-	-	36	-	
2	T50 T63 T80	min	53	70,5	88	105,5	123	140,5	65	-	-	36	-	48	
		max	62,5	82,5	102,5	122,5	142,5	162,5	+20	94	-	-	45,5	-	
2	T100 T125	min	71	98	125	152	179	206	+27	94	-	-	45,5	-	
		max	80,8	114,8	148,8	-	-	-	+34	94	-	-	45,5	-	
3	T200	min	95	135	175	215	255	295	+40	132	-	-	67	-	
		max	-	-	-	-	-	-	-	-	-	-	-	-	

^(*) Modular enclosure 3 chambers max

TB Base mounting with screws (direct handle)

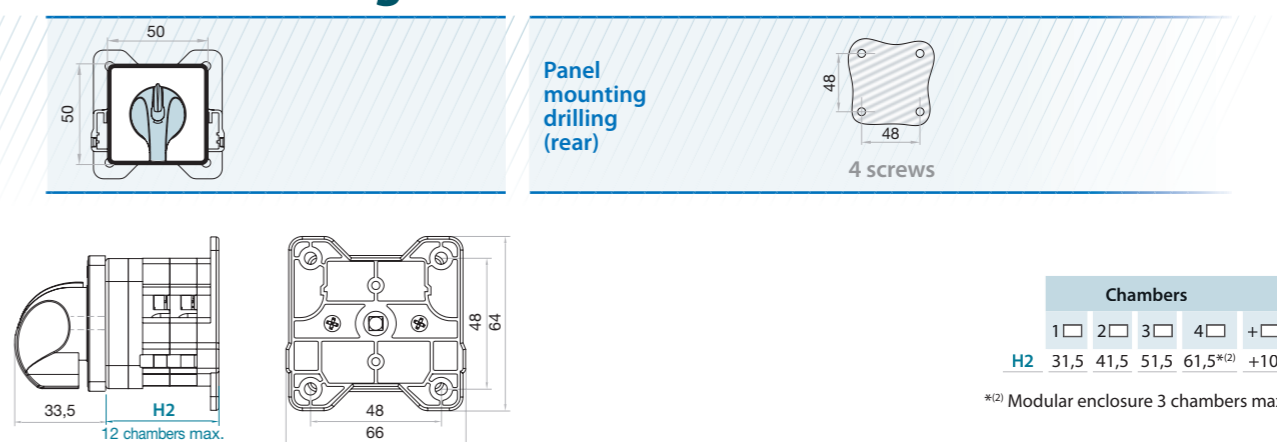

^(*) Modular enclosure 3 chambers max

TF Base mounting with screws or DIN rail (direct handle)

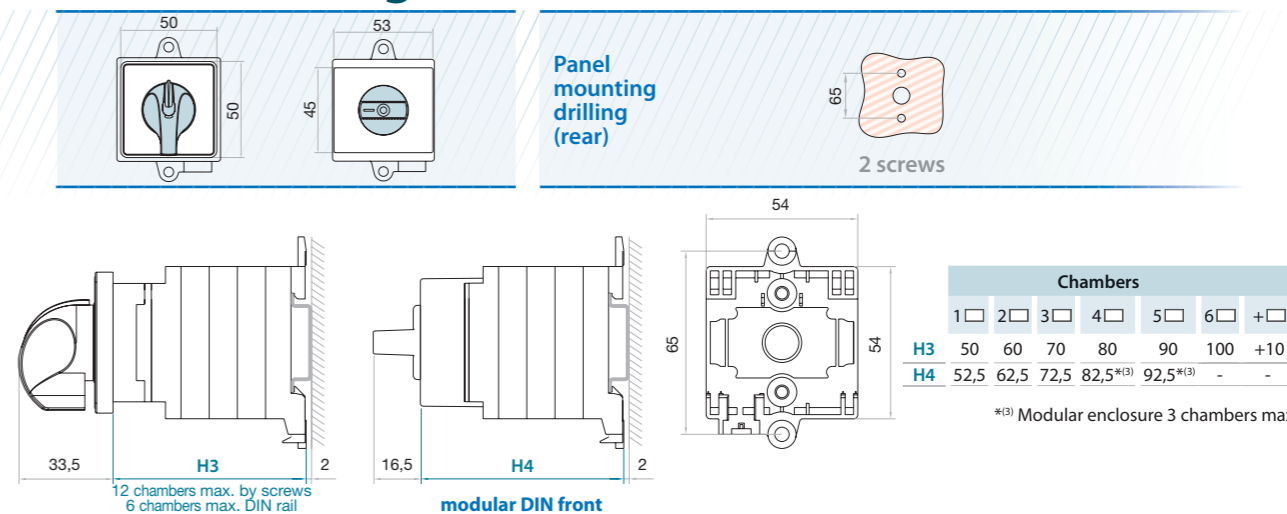

^(*) Modular enclosure 3 chambers max

Technical specifications

According to IEC 60947-3			Size 0			Size 1			Size 2					Size 3									
			T12	T20	T16	T25	T32	T40	T50	T63	T80	T100	T125	T175	T200	T250	T315	T400	T630	T800	T1250	T1600	
Rated thermal current	Ith	A	16	25	25	32	40	50	63	80	80	125	125	200	200	250	315	400	630	800	1000	1600	
Rated insulation voltage	Ui	V	500	500	690	690	690	690	690	690	690	690	1000	690	690	690	690	690	690	690	690	690	
Rated impulse withstand voltage	Uimp	kV	6	6	6	6	8	8	8	8	8	8	8	8	8	8	8	8	8	8	8	8	
			Ue																				
AC rated operational current	Ie	Ue 415V AC21A	A	16	25	25	32	40	50	63	80	80	125	125	200	200	250	315	315	315	400	500	500
		Ue 415V AC22A	A	16	25	25	32	40	50	63	80	80	115	115	200	200	250	315	250	315	315	315	400
		Ue 415V AC23A	A	10	25	16	20	25	32	63	63	63	100	100	200	200	200	-	-	-	-	-	-
Rated conditional short-circuit current		kA	10	10	10	10	10	10	15	15	15	15	15	15 ^{*)}	15	15	15	15	10	10	10	10	
Rated maximum current	gL-gG	A	25	25	32	32	50	50	80	80	80	125	125	160	200	250	315	400	630	800	1000	2x800	
Rated breaking capacity	400V; cos φ=0,45	A	80	100	160	200	256	320	504	504	504	640	640	1600	1450	2000	2240	1450	1450	1450	1450	1450	
Rated short-time withstand current (1 sec)		A	240	400	500	650	800	800	1600	1600	1600	2500	2500	3500	4400	4400	4400	6000	7000	7600	8000	8200	
Mechanical durability (according to the standards, for other values please consult)			10000 10000 10000 10000 10000 10000 10000 10000 8000 8000 8000 8000 8000 8000 5000 5000 3000 3000 3000																				
Maximum connection capacity																							
Rigid copper conductor		mm ²	2x4	2x4	2x6	2x6	2x10	2x10	16/25 ^{*)}	16/25 ^{*)}	16/25 ^{*)}	35/50 ^{*)}	35/50 ^{*)}	95	95	120	185	-	-	-	-	-	
Flexible copper conductors		mm ²	2x2,5	2x2,5	2x4	2x4	2x6	2x6	10/16 ^{*)}	10/16 ^{*)}	10/16 ^{*)}	16/35 ^{*)}	16/35 ^{*)}	95	95	120	185	-	-	-	-	-	

According to UL508 - CAN / CSA C22.2 N° 14			Size 0			Size 1			Size 2					Size 3								
			T12	T20	T16	T25	T32	T40	T50	T63	T80	T100	T125	T175	T200	T250	T315	T400	T630	T800	T1250	T1600
Rated thermal current	Ith	A	12	20	16	25	32	40	63	63	63	100	100	200	200	200	200	-	-	-	-	-
General use rating			A	12	20	16	25	32	40	63	63	63	100	100	200	200	200	-	-	-	-	-
			Vac	300	300	600	600	600	600	600	600	600	600	600	600	600	600	-	-	-	-	-
AC rated operational power	3x240V	HP	2	5	5	7,5	10	15	20	20	20	30	30	25	60	60	60	-	-	-	-	-
	3x480V	HP	-	-	10	15	20	25	40	40	40	50	50	60	75	75	75	-	-	-	-	-
	3x600V	HP	-	-	10	15	20	25	40	40	40	50	50	60	60	60	60	-	-	-	-	-

*) 500V size "0" **) With extension terminals **) With phase barriers

Normal service conditions*

- Ambient air temperature (°C): -5°...+40°.
- Maximum altitude: 2.000 m.
- Maximum humidity: 90%.
- Pollution degree: 3 (standard for industrial applications).
- Rated frequency at AC utilization categories: 50/60 Hz.

- Rated duties at utilization categories AC21A, AC22A y AC23A: Continuing (8 hours); uninterrupted.
- Rated duties at utilization categories AC3 and AC4: Intermittent; temporary
- Switching direct currents: For L/R<50msg, rated operational current (Ie) can be dealt with up to 30Vdc. With higher voltages, several contacts have to be connected in series.

* Please consult for other service conditions.



According to IEC 60947-3			Size 0						
			TB20	TB25	TB32	TF12	TF16	TF25	
Rated thermal current	Ith	A	20	25	32	20	25	32	
Rated insulation voltage	Ui	V	500	500	500	690	690	690	
Rated impulse withstand voltage	Uimp	kV	4	4	4	6	6	6	
			Ue						
AC rated operational current	Ie	Ue 415V AC21A	A	20	25	32	20	25	32
		Ue 415V AC22A	A	20	25	32	20	25	32
		Ue 415V AC23A	A	20	25	32	-	-	-
Rated conditional short-circuit current		kA	5	5	5	5	5	5	
Rated maximum current	gL-gG	A	35	35	35	20	25	32	
Rated breaking capacity	400V; cos φ=0,45	A	160	200	256	100	160	200	
Rated short-time withstand current (1 sec)		A	240	400	500	350	400	500	
Mechanical durability (according to the standards, for other values please consult)			10000 10000 10000 10000 10000 10000						
Maximum connection capacity									
Rigid copper conductor		mm ²	1x10 2x6	1x10 2x6	1x10 2x6	1x10	1x10	1x10	
Flexible copper conductors		mm ²	1x6 2x4	1x6 2x4	1x6 2x4	1x6	1x6	1x6	

According to UL508 - CAN / CSA C22.2 N° 14			Size 0					
			TF12	TF16	TF25			
Rated thermal current	Ith	A	-	-	16	20	25	
General use rating			A	-	-	16	20	25
			Vac	-	-	600	600	600
AC rated operational power	3x240V	HP	-	-	2	5	7,5	
	3x480V	HP	-	-	5	10	12	
	3x600V	HP	-	-	5	10	15	

According to IEC 60947-3 / IEC 60947-5				Size 0
				TP10
Rated thermal current	Ith	A		12
Rated insulation voltage	Ui	V		500
Rated impulse withstand voltage	Uimp	kV		4
				Ue
AC rated operational current	Ie	Ue 415V AC13A	A	10
		Ue 415V AC21A	A	12
		Ue 415V AC22A	A	12
		Ue 415V AC23A	A	10
Rated conditional short-circuit current		kA		5
Rated maximum current	gL-gG	A		16
Rated breaking capacity	400V; cos φ=0,45	A		80
Rated short-time withstand current (1 sec)		A		100
Mechanical durability (thousand of operations)				1000
Maximum connection capacity				
Rigid copper conductor		mm ²		2x4
Flexible copper conductors		mm ²		2x2,5

Approvals TP:

