













Index

Page

	Main Switches for Panel Mounting	280
	Main Switches-Emergency-Stop for Single Hole Mounting	281
	Main Switches for Base Mounting with Door Clutch	282
	Main Switches-Emergency-Stop for Panel Mounting	286
	Main Switches-Emergency-Stop for Single Hole Mounting	287
	Main Switches-Emergency-Stop for Base Mounting with Door Clutch	288
	Main Switches-Emergency-Stop for Distribution Boards	290
	Maintenance and Safety Switches, in Plastic Enclosure	291
	Switch Disconnectors for Panel Mounting	292
	Switch Disconnectors for Single Hole Mounting	293
	Switch Disconnectors for Base Mounting	293
	Switch Disconnectors for Distribution Boards	295
	Switch Disconnectors in Plastic Enclosure	296
	Add-on modules	297
	Technical Data	299
	Dimensions	300

Contactors, Motor-Starter

Circuit Breakers

Manual Motor-Starters

Switches

AC-Main Switches

DC-Switch Disconnector

Push Buttons

Representatives, Suppliers

Ratings								Panel mounting 4 hole mount. IP66	Single hole mount. Ø22,5mm IP66			
Type	Rated current			Motor			Plate Switch					
	Therm. I _{th} open A	AC21 A	at U _e V	AC3 3~400V kW	AC23 3~400V A	AC23 3~400V kW	mm	EH4	EHN4	EHN1	Z	ZHN1
LTS20	20	20	690	5,5	16	7,5	48 [□]	LTS20 E ¹⁾ ..	LTS20 Z ¹⁾ ..			
LTS25	25	25	690	7,5	20	10	48 [□]	LTS25 E ¹⁾ ..	LTS25 Z ¹⁾ ..			
LTS32	32	32	690	11	25	12,5	48 [□]	LTS32 E ¹⁾ ..	LTS32 Z ¹⁾ ..			
LTS40	40	40	690	15	32	16	48 [□]	LTS40 E ¹⁾ ..	LTS40 Z ¹⁾ ..			
LTS63	63	63	690	18,5	45	22	48 [□]	LTS63 E ¹⁾ ..	-			
LTS80	80	80	690	18,5	45	22	48 [□]	LTS80 E ¹⁾ ..	-			
LTS85	85	85	690	22	60	30	64 [□]	LTS85 E ¹⁾ ..	-			
LTS100	100	100	690	30	72	37	64 [□]	LTS100 E ¹⁾ ..	-			
LTS125	125	125	690	37	85	45	64 [□]	LTS125 E ¹⁾ ..	-			
LT160	160	160	690	45	110	55	88 [□]	LT160 E ¹⁾ ..	-			

Switch disconnecter LT.. 20 - 160A

Switch disconnectors are to be used as an ON-OFF-switch where a high breaking capacity with high contact pressure and in fact better short circuit behavior is necessary. These applications are:

Main switches according to IEC/EN 60204 respectively VDE0113 with interlocking device, terminal protection and restrictive contacts.

Switch disconnectors according to IEC/EN 60947-3 and VDE 0660 part 107 with break distance for 690V.

Motor switches 3-pole or 4-pole; according to IEC/EN 60947-3 respectively VDE 0660 part 107, motor switches series LT are dimensioned for switching high rated current AC3 and AC23A.

Switch program

On-Off Switch 3-pole	A3
On-Off Switch 4-pole	A4
On-Off Switch 6-pole	A6
On-Off Switch 8-pole	A8
Changeover Switches 3-pole	U3
Changeover Switches 4-pole	U4
On-Off Switch 3-pole	T300 (for LT160)
On-Off Switch 4-pole	T400 (for LT160)

Main switches and Main switches with Emergency-Stop function

According to standards IEC/EN60204 or VDE0113, all electrical equipment of industrial machines must be equipped with a main switch. This must permit disconnection of all the electrical equipment during cleaning, maintenance and repair work, and other extended periods when it is stationary. In case of two or more main switches, an interlock system must be used. It is recommended to use a multiple-pole main switch (cam switch).

Main switches have to correspond to:

- Switch disconnecter according to IEC/EN 60947-3 and VDE 0660 part 107 for utilization category AC23-B or DC-23B.
- Disconnectors are selected according to thermal rated current. They must possess a contact that ensures load switching via the contactors (see switching program A3-10). This contact must have a sufficient AC15 switching capacity.
- The interruption capacity of the switch must equal or exceed the locked rotor current of the largest motor plus the total current of all other electrical equipment in the circuit.

Requirements:

Interruption of the electrical equipment, with only on and off positions clearly marked with O and I.

It must be lockable in the off setting.

The line terminals of the main switch must be protected according to utilization category IP2X.

Colour of handle black or grey.

Main switches with Emergency-Off function are additional supplied with red handles and contrasting yellow escutcheon plates.

1) Main Switches (H1/H4 Main Switches-Emergency-Stop (HN1/HN4))
Switch Disconnectors (without H(N)1/4)

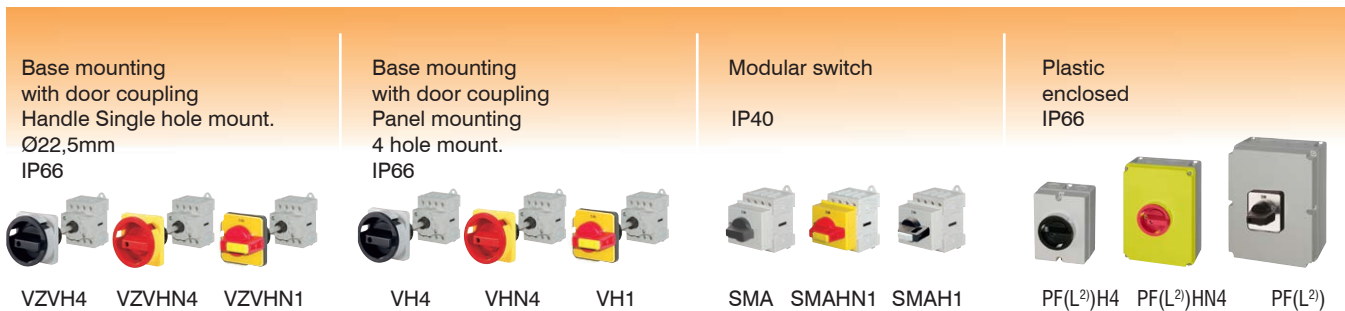

Base mounting with door coupling Handle Single hole mount. Ø22,5mm IP66	Base mounting with door coupling Panel mounting 4 hole mount. IP66	Modular switch IP40	Plastic enclosed IP66
VZVH4 VZVHN4 VZVHN1	VH4 VHN4 VH1	SMA SMAHN1 SMAH1	PF(L ²)H4 PF(L ²)HN4 PF(L ²)
LTS20 VZV ¹⁾ ..	LTS20 V ¹⁾ ..	LTS20 SMA ¹⁾ ..	LTS20 PF(L ²) ¹⁾ ..
LTS25 VZV ¹⁾ ..	LTS25 V ¹⁾ ..	LTS25 SMA ¹⁾ ..	LTS25 PF(L ²) ¹⁾ ..
LTS32 VZV ¹⁾ ..	LTS32 V ¹⁾ ..	LTS32 SMA ¹⁾ ..	LTS32 PF(L ²) ¹⁾ ..
LTS40 VZV ¹⁾ ..	LTS40 V ¹⁾ ..	LTS40 SMA ¹⁾ ..	LTS40 PF(L ²) ¹⁾ ..
LTS63 VZV ¹⁾ ..	LTS63 V ¹⁾ ..	LTS63 SMA ¹⁾ ..	LTS63 PFL ¹⁾ ..
LTS80 VZV ¹⁾ ..	LTS80 V ¹⁾ ..	LTS80 SMA ¹⁾ ..	LTS80 PFL ¹⁾ ..
LTS85 VZV ¹⁾ ..	LTS85 V ¹⁾ ..	LTS85 SMA ¹⁾ ..	LTS85 PFL ¹⁾ ..
LTS100 VZV ¹⁾ ..	LTS100 V ¹⁾ ..	LTS100 SMA ¹⁾ ..	LTS100 PFL ¹⁾ ..
LTS125 VZV ¹⁾ ..	LTS125 V ¹⁾ ..	LTS125 SMA ¹⁾ ..	LTS125 PFL ¹⁾ ..
-	LT160 V ¹⁾ ..	-	LT160 PF ¹⁾ .. ³⁾

Approvals

Area	USA, Canada / UL	Europe	Russia / EAC	CB/CCA-Certificates
Type				

Switch disconnecter (UL-Listed as MANUAL MOTOR CONTROLLER and suitable as MOTOR DISCONNECT)

LTS20	o	o	o	o	
LTS25	o	o	o	o	
LTS32	o	o	o	o	
LTS40	o	o	o	o	
LTS63	o	o	o	o	
LTS80	o	o	o	o	
LTS85	o	o	-	-	
LTS100	o	o	-	-	
LTS125	o	o	-	-	
LT160	o	o	-	o	

o in standard version approved
/ No testing required CE
x in test
- Not provided for test til now

Terminal screws

Devices Type	Kind of connection		Tightening torque		Protection class of terminals ⁴⁾
	screw with clamp box	Screwdriver	Nm	lb. inch	
Switch Disconnectors LTS20, LTS25 LTS32, LTS40 LTS63, LTS80 LTS85, LTS100, LTS125	 M3,5 M5 M6	 Pz2 Pz2 Pz3	1,7 - 2,3 2,8 - 4 1,7 - 4,5	15 - 20 25 - 35 15 - 40	IP20 IP20 IP20 IP20
LT160	M10		14	124	IP20









1) Main Switches (H1/H4 Main Switches-Emergency-Stop (HN1/HN4))
Switch Disconnectors (without H(N)1/4)

2) PFL... larger enclosure

3) IP.. Type..

4) Protection degree of the terminals with connected insulated conductor. Additional protection with terminal cover (KLAD).

Main Switches for Panel Mounting, lockable IP66, c(UL)us Type 3R

	max. padlocks	AC21 690V	AC23 3x400V	Plate	Type	Pack pcs.	Weight kg/pcs.
3-pole, padlock device SV1 							
		20A	7,5kW	48 □ ¹⁾	LTS20 EH1 A3	1	0,15
		25A	10kW	48 □ ¹⁾	LTS25 EH1 A3	1	0,15
		32A	12,5kW	48 □ ¹⁾	LTS32 EH1 A3	1	0,15
		40A	16kW	48 □ ¹⁾	LTS40 EH1 A3	1	0,15
		63A	22kW	48 □ ¹⁾	LTS63 EH1 A3	1	0,17
		80A	22kW	48 □ ¹⁾	LTS80 EH1 A3	1	0,17
4-pole, padlock device SV1 							
		20A	7,5kW	48 □ ¹⁾	LTS20 EH1 A4	1	0,19
		25A	10kW	48 □ ¹⁾	LTS25 EH1 A4	1	0,19
		32A	12,5kW	48 □ ¹⁾	LTS32 EH1 A4	1	0,19
		40A	16kW	48 □ ¹⁾	LTS40 EH1 A4	1	0,19
		63A	22kW	48 □ ¹⁾	LTS63 EH1 A4	1	0,21
		80A	22kW	48 □ ¹⁾	LTS80 EH1 A4	1	0,21
3-pole, padlock device SV4(34) 							
		20A	7,5kW	64 □ ²⁾	LTS20 EH4 A3	1	0,17
		25A	10kW	64 □ ²⁾	LTS25 EH4 A3	1	0,17
		32A	12,5kW	64 □ ²⁾	LTS32 EH4 A3	1	0,17
		40A	16kW	64 □ ²⁾	LTS40 EH4 A3	1	0,17
		63A	22kW	64 □ ²⁾	LTS63 EH4 A3	1	0,19
		80A	22kW	64 □ ²⁾	LTS80 EH4 A3	1	0,19
		80A	30kW	64 □ ²⁾	LTS85 EH4 A3	1	0,39
		100A	37kW	64 □ ²⁾	LTS100 EH4 A3	1	0,39
		125A	45kW	64 □ ²⁾	LTS125 EH4 A3	1	0,39
		160A	55kW	88 □	LT160 EH34 T300	1	1,16
4-pole, padlock device SV4(34) 							
		20A	7,5kW	64 □ ²⁾	LTS20 EH4 A4	1	0,20
		25A	10kW	64 □ ²⁾	LTS25 EH4 A4	1	0,20
		32A	12,5kW	64 □ ²⁾	LTS32 EH4 A4	1	0,20
		40A	16kW	64 □ ²⁾	LTS40 EH4 A4	1	0,20
		63A	22kW	64 □ ²⁾	LTS63 EH4 A4	1	0,23
		80A	22kW	64 □ ²⁾	LTS80 EH4 A4	1	0,23
		80A	30kW	64 □ ²⁾	LTS85 EH4 A4	1	0,44
		100A	37kW	64 □ ²⁾	LTS100 EH4 A4	1	0,44
		125A	45kW	64 □ ²⁾	LTS125 EH4 A4	1	0,44
		160A	55kW	88 □	LT160 EH34 T400	1	1,55

Add-on modules see page 297







Extended Switch Shaft for switches for panel mounting type suffix +VW“x“

x = panel thickness



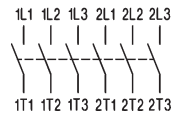

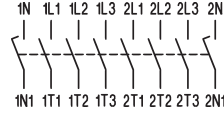

1) Types with padlock device 64 □ type suffix **64**, ordering example: LTS32 EH1**64** A3, on request

2) Types with padlock device 88 □ type suffix **88**, ordering example: LTS32 EH4**88** A3, on request



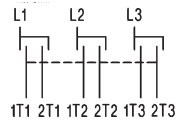

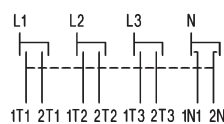

Main Switches for Panel Mounting, lockable IP66, cUL^{us} Type 3R

		max. padlocks	AC21 690V	AC23 3x400V	Plate	Type	Pack pcs.	Weight kg/pcs.
6-pole, padlock device SV4 								
			20A	7,5kW	64 □	LTS20 EH4 A6	1	0,30
			25A	10kW	64 □	LTS25 EH4 A6	1	0,30
			32A	12,5kW	64 □	LTS32 EH4 A6	1	0,30
			40A	16kW	64 □	LTS40 EH4 A6	1	0,30
			63A	22kW	64 □	LTS63 EH4 A6	1	0,34
			80A	22kW	64 □	LTS80 EH4 A6	1	0,34
8-pole, padlock device SV4 								
			20A	7,5kW	64 □	LTS20 EH4 A8	1	0,38
			25A	10kW	64 □	LTS25 EH4 A8	1	0,38
			32A	12,5kW	64 □	LTS32 EH4 A8	1	0,38
			40A	16kW	64 □	LTS40 EH4 A8	1	0,38
			63A	22kW	64 □	LTS63 EH4 A8	1	0,42
			80A	22kW	64 □	LTS80 EH4 A8	1	0,42

Changeover Switches with padlockdevice for Panel Mounting, lockable IP66

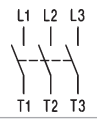

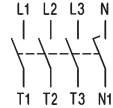

3-pole, padlock device SV4 								
			20A	7,5kW	64 □	LTS20 EH4 U3	1	0,30
			25A	10kW	64 □	LTS25 EH4 U3	1	0,30
			32A	12,5kW	64 □	LTS32 EH4 U3	1	0,30
			40A	16kW	64 □	LTS40 EH4 U3	1	0,30
			63A	22kW	64 □	LTS63 EH4 U3	1	0,34
4-pole, padlock device SV4 								
			20A	7,5kW	64 □	LTS20 EH4 U4	1	0,38
			25A	10kW	64 □	LTS25 EH4 U4	1	0,38
			32A	12,5kW	64 □	LTS32 EH4 U4	1	0,38
			40A	16kW	64 □	LTS40 EH4 U4	1	0,38
			63A	22kW	64 □	LTS63 EH4 U4	1	0,42

Main Switches for Single Hole Mounting IP66, cUL^{us} Type 4X

		max. padlocks	AC21 690V	AC23 3x400V	Plate	Type	Pack pcs.	Weight kg/pcs.
3-pole, padlock device SV1 								
			20A	7,5kW	48 □	LTS20 ZH1 A3	1	0,16
			25A	10kW	48 □	LTS25 ZH1 A3	1	0,16
			32A	12,5kW	48 □	LTS32 ZH1 A3	1	0,16
			40A	16kW	48 □	LTS40 ZH1 A3	1	0,16
4-pole, padlock device SV1 								
			20A	7,5kW	48 □	LTS20 ZH1 A4	1	0,20
			25A	10kW	48 □	LTS25 ZH1 A4	1	0,20
			32A	12,5kW	48 □	LTS32 ZH1 A4	1	0,20
			40A	16kW	48 □	LTS40 ZH1 A4	1	0,20

Add-on modules see page 297

Main Switches, Base Mounting with Door Clutch for Single-Hole Mounting
 Depth X is adjustable (delivered with X_{max} see below), IP66,  Type 4X

	max. padlocks	AC21 690V	AC23 3x400V	Plate	Type	Pack pcs.	Weight kg/pcs.
3-pole, padlock device SV4 							
		20A	7,5kW	64 □	LTS20 VZVH4 A3	1	0,19
		25A	10kW	64 □	LTS25 VZVH4 A3	1	0,19
		32A	12,5kW	64 □	LTS32 VZVH4 A3	1	0,19
		40A	16kW	64 □	LTS40 VZVH4 A3	1	0,19
		63A	22kW	64 □	LTS63 VZVH4 A3	1	0,22
		80A	22kW	64 □	LTS80 VZVH4 A3	1	0,22
		85A	30kW	64 □	LTS85 VZVH4 A3	1	0,40
		100A	37kW	64 □	LTS100 VZVH4 A3	1	0,40
		125A	45kW	64 □	LTS125 VZVH4 A3	1	0,40
4-pole, padlock device SV4 							
		20A	7,5kW	64 □	LTS20 VZVH4 A4	1	0,20
		25A	10kW	64 □	LTS25 VZVH4 A4	1	0,20
		32A	12,5kW	64 □	LTS32 VZVH4 A4	1	0,20
		40A	16kW	64 □	LTS40 VZVH4 A4	1	0,20
		63A	22kW	64 □	LTS63 VZVH4 A4	1	0,26
		80A	22kW	64 □	LTS80 VZVH4 A4	1	0,26
		85A	30kW	64 □	LTS85 VZVH4 A4	1	0,45
		100A	37kW	64 □	LTS100 VZVH4 A4	1	0,45
		125A	45kW	64 □	LTS125 VZVH4 A4	1	0,45
6-pole, padlock device SV4 							
		20A	7,5kW	64 □	LTS20 VZVH4 A6	1	0,32
		25A	10kW	64 □	LTS25 VZVH4 A6	1	0,32
		32A	12,5kW	64 □	LTS32 VZVH4 A6	1	0,32
		40A	16kW	64 □	LTS40 VZVH4 A6	1	0,32
		63A	22kW	64 □	LTS63 VZVH4 A6	1	0,37
		80A	22kW	64 □	LTS80 VZVH4 A6	1	0,37
8-pole, padlock device SV4 							
		20A	7,5kW	64 □	LTS20 VZVH4 A8	1	0,34
		25A	10kW	64 □	LTS25 VZVH4 A8	1	0,34
		32A	12,5kW	64 □	LTS32 VZVH4 A8	1	0,34
		40A	16kW	64 □	LTS40 VZVH4 A8	1	0,34
		63A	22kW	64 □	LTS63 VZVH4 A8	1	0,45
		80A	22kW	64 □	LTS80 VZVH4 A8	1	0,45

Depth
 Single Hole Mounting Ø22mm
 LTS.. VZV..

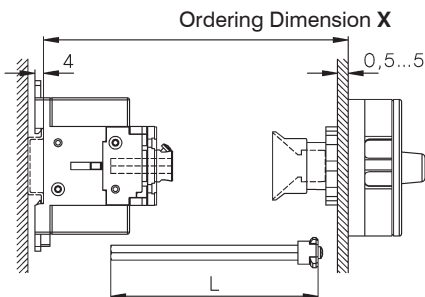

Type		X min	X max	L
LTS20-80 VZV..	3, 4-pole	91	190	X - 40±3
LTS20-80 VZV..	6, 8-pole	111	190	X - 60±3
LTS85-125 VZV..	3, 4-pole	95	190	X - 44±3

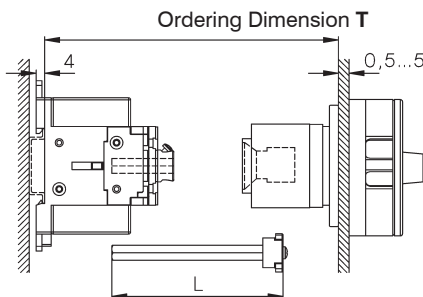

4-Hole Mounting
 LTS.. V(H).. (3, 4-pole)



Type		T min	T max	L	Type	T min	T max
LTS20-80 VH..		111	190	T - 60±3	LTS160 VH..	120	450
LTS85-125 VH..		115	190	T - 64±3			

greater X- and T-Dimensions (max. 380mm for LTS..) on request

Main Switches, Base Mounting with Door Clutch, Padlock Device for 4-Hole Mounting
 Depth T is adjustable (delivered with T_{max} see page 271), IP66, cUL_{us} Type 4X

	max. padlocks	AC21 690V	AC23 3x400V	Plate	Type	Pack pcs.	Weight kg/pcs.
3-pole, padlock device SV4(34)  							
		20A	7,5kW	64 □ ¹⁾	LTS20 VH4 A3	1	0,20
		25A	10kW	64 □ ¹⁾	LTS25 VH4 A3	1	0,20
		32A	12,5kW	64 □ ¹⁾	LTS32 VH4 A3	1	0,20
		40A	16kW	64 □ ¹⁾	LTS40 VH4 A3	1	0,20
		63A	22kW	64 □ ¹⁾	LTS63 VH4 A3	1	0,24
		80A	22kW	64 □ ¹⁾	LTS80 VH4 A3	1	0,24
		85A	30kW	64 □ ¹⁾	LTS85 VH4 A3	1	0,40
		100A	37kW	64 □ ¹⁾	LTS100 VH4 A3	1	0,40
		125A	45kW	64 □ ¹⁾	LTS125 VH4 A3	1	0,40
		160A	55kW	88 □	LT160 VH34 T300	1	1,38

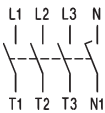
4-pole, padlock device SV4(34)  							
		20A	7,5kW	64 □ ¹⁾	LTS20 VH4 A4	1	0,21
		25A	10kW	64 □ ¹⁾	LTS25 VH4 A4	1	0,21
		32A	12,5kW	64 □ ¹⁾	LTS32 VH4 A4	1	0,21
		40A	16kW	64 □ ¹⁾	LTS40 VH4 A4	1	0,21
		63A	22kW	64 □ ¹⁾	LTS63 VH4 A4	1	0,28
		80A	22kW	64 □ ¹⁾	LTS80 VH4 A4	1	0,28
		85A	30kW	64 □ ¹⁾	LTS85 VH4 A4	1	0,45
		100A	37kW	64 □ ¹⁾	LTS100 VH4 A4	1	0,45
		125A	45kW	64 □ ¹⁾	LTS125 VH4 A4	1	0,45
		160A	55kW	88 □	LT160 VH34 T400	1	1,77

Emergency-Stop-Main Switches, Base Mounting with Door Clutch for Single-Hole Mounting
 Depth X is not adjustable, declare depth X when ordering, IP66, cUL_{us} Type 4X

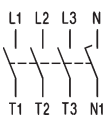
4-pole, padlock device SV4  							
		20A	7,5kW	64 □	LTS20 VZH4 A4 X..	1	0,18
		25A	10kW	64 □	LTS25 VZH4 A4 X..	1	0,18
		32A	12,5kW	64 □	LTS32 VZH4 A4 X..	1	0,18
		40A	16kW	64 □	LTS40 VZH4 A4 X..	1	0,18
		63A	22kW	64 □	LTS63 VZH4 A4 X..	1	0,25
		80A	22kW	64 □	LTS80 VZH4 A4 X..	1	0,25

Declare depth X when ordering

Type	Preference values for X
LT.. VZH..	80, 85, 104, 129 (tolerance -3, +1,5)

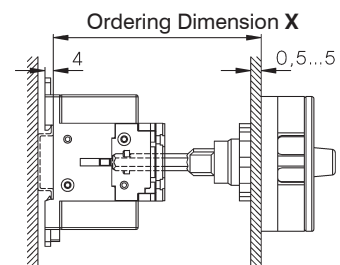



Add-on modules see page 297

1) Types with padlock device 88 'type suffix **88**, ordering example: LTS32 VHN**488** A3, on request

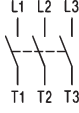
Main Switches for Distribution Boards, lockable IP40, Open Type

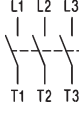
		max. padlocks	AC21 690V	AC23 3x400V	Plate	Type	Pack pcs.	Weight kg/pcs.
3-pole, padlock device SV1  								
			20A	7,5kW	52x45	LTS20 SMAH1 A3 ²⁾	1	0,15
			25A	10kW	52x45	LTS25 SMAH1 A3 ²⁾	1	0,15
			32A	12,5kW	52x45	LTS32 SMAH1 A3 ²⁾	1	0,15
			40A	16kW	52x45	LTS40 SMAH1 A3 ²⁾	1	0,15
			63A	22kW	52x45	LTS63 SMAH1 A3 ²⁾	1	0,18
			80A	22kW	52x45	LTS80 SMAH1 A3 ²⁾	1	0,18
			85A	30kW	78x45	LTS85 SMAH1 A3	1	0,37
		100A	37kW	78x45	LTS100 SMAH1 A3	1	0,37	
		125A	45kW	78x45	LTS125 SMAH1 A3	1	0,37	

4-pole, padlock device SV1  								
			20A	7,5kW	52x45	LTS20 SMAH1 A4 ²⁾	1	0,16
			25A	10kW	52x45	LTS25 SMAH1 A4 ²⁾	1	0,16
			32A	12,5kW	52x45	LTS32 SMAH1 A4 ²⁾	1	0,16
			40A	16kW	52x45	LTS40 SMAH1 A4 ²⁾	1	0,16
			63A	22kW	52x45	LTS63 SMAH1 A4 ²⁾	1	0,21
			80A	22kW	52x45	LTS80 SMAH1 A4 ²⁾	1	0,21
			85A	30kW	78x45	LTS85 SMAH1 A4	1	0,42
		100A	37kW	78x45	LTS100 SMAH1 A4	1	0,42	
		125A	45kW	78x45	LTS125 SMAH1 A4	1	0,42	

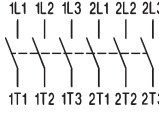
6-pole, padlock device SV1 (64)  								
			20A	7,5kW	52x45	LTS20 SMAH1 A6	1	0,29
			25A	10kW	52x45	LTS25 SMAH1 A6	1	0,29
			32A	12,5kW	52x45	LTS32 SMAH1 A6	1	0,29
			40A	16kW	52x45	LTS40 SMAH1 A6	1	0,29
			63A	22kW	97x45	LTS63 SMAH1 A6 ¹⁾	1	0,34
		80A	22kW	97x45	LTS80 SMAH1 A6 ¹⁾	1	0,34	

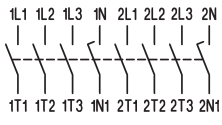
8-pole, padlock device SV164  								
			20A	7,5kW	97x45	LTS20 SMAH1 A8	1	0,31
			25A	10kW	97x45	LTS25 SMAH1 A8	1	0,31
			32A	12,5kW	97x45	LTS32 SMAH1 A8	1	0,31
			40A	16kW	97x45	LTS40 SMAH1 A8	1	0,31
			63A	22kW	126x45	LTS63 SMAH1 A8	1	0,42
		80A	22kW	126x45	LTS80 SMAH1 A8	1	0,42	

Changeover Switch with Padlock Device for Distribution Boards, lockable

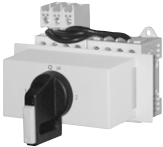
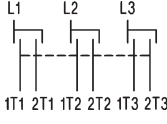

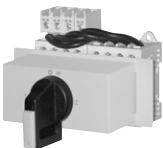
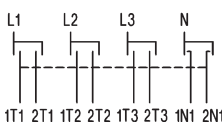









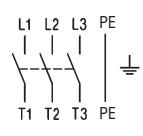













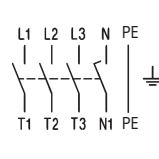













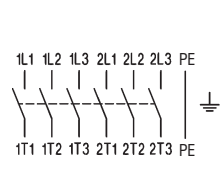









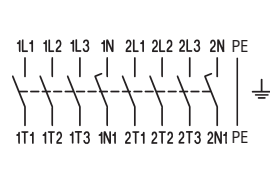









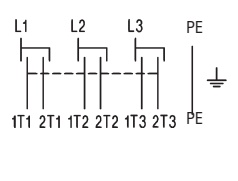





3-pole, padlock device SV164  								
			20A	7,5kW	97x45	LTS20 SMAH1 U3	1	0,29
			25A	10kW	97x45	LTS25 SMAH1 U3	1	0,29
			32A	12,5kW	97x45	LTS32 SMAH1 U3	1	0,29
			40A	16kW	97x45	LTS40 SMAH1 U3	1	0,29
		63A	22kW	97x45	LTS63 SMAH1 U3	1	0,34	

4-pole, padlock device SV164  								
			20A	7,5kW	97x45	LTS20 SMAH1 U4	1	0,31
			25A	10kW	97x45	LTS25 SMAH1 U4	1	0,31
			32A	12,5kW	97x45	LTS32 SMAH1 U4	1	0,31
			40A	16kW	97x45	LTS40 SMAH1 U4	1	0,31
		63A	22kW	126x45	LTS63 SMAH1 U4	1	0,42	

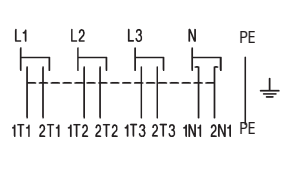
1) With padlock device SV164









2) Emergency-Stop-Main Switches for Distribution Boards, lockable with low height handle, IP40
 Type with Type-suffix „+SV1N“ e.g.: **LTS40 SMAHN1 A3 +SV1N**

Maintenance and Safety Switches, in Plastic Enclosure, lockable IP66,  Type 4X

	max. padlocks	AC21 690V	AC23 3x400V	Plate	Type	Pack pcs.	Weight kg/pcs.	
3-pole, padlock device SV4(34)  								
 		20A	7,5kW	64 	LTS20 PF(L ¹)H4 A3	1	0,32	
		25A	10kW	64 	LTS25 PF(L ¹)H4 A3	1	0,32	
		32A	12,5kW	64 	LTS32 PF(L ¹)H4 A3	1	0,32	
		40A	16kW	64 	LTS40 PF(L ¹)H4 A3	1	0,32	
		63A	22kW	64 	LTS63 PFLH4 A3	1	0,60	
		80A	22kW	64 	LTS80 PFLH4 A3	1	0,60	
		85A	30kW	64 	LTS85 PFLH4 A3	1	0,78	
		100A	37kW	64 	LTS100 PFLH4 A3	1	0,78	
Larger enclosure Type: ..PFL..	on request	125A	45kW	64 	LTS125 PFLH4 A3	1	0,78	
	on request	160A	55kW	88 	LT160 PFH34 T300	1	2,09	
4-pole, padlock device SV4(34)  								
 		20A	7,5kW	64 	LTS20 PF(L ¹)H4 A4	1	0,33	
		25A	10kW	64 	LTS25 PF(L ¹)H4 A4	1	0,33	
		32A	12,5kW	64 	LTS32 PF(L ¹)H4 A4	1	0,33	
		40A	16kW	64 	LTS40 PF(L ¹)H4 A4	1	0,33	
		63A	22kW	64 	LTS63 PFLH4 A4	1	0,64	
		80A	22kW	64 	LTS80 PFLH4 A4	1	0,64	
		85A	30kW	64 	LTS85 PFLH4 A4	1	0,83	
		100A	37kW	64 	LTS100 PFLH4 A4	1	0,83	
Larger enclosure Type appendix +PF3	on request	125A	45kW	64 	LTS125 PFLH4 A4	1	0,83	
+PF3/M50	on request	160A	55kW	88 	LT160 PFH34 T400	1	2,47	
6-pole, padlock device SV4  								
 		20A	7,5kW	64 	LTS20 PFLH4 A6	1	1,39	
		25A	10kW	64 	LTS25 PFLH4 A6	1	1,39	
		32A	12,5kW	64 	LTS32 PFLH4 A6	1	1,39	
		40A	16kW	64 	LTS40 PFLH4 A6	1	1,39	
		63A	22kW	64 	LTS63 PFLH4 A6	1	1,42	
		80A	22kW	64 	LTS80 PFLH4 A6	1	1,42	
	knockoutlets M50/40 +PF3/M50	on request						
	8-pole, padlock device SV4  							
 		20A	7,5kW	64 	LTS20 PFLH4 A8	1	1,44	
		25A	10kW	64 	LTS25 PFLH4 A8	1	1,44	
		32A	12,5kW	64 	LTS32 PFLH4 A8	1	1,44	
		40A	16kW	64 	LTS40 PFLH4 A8	1	1,44	
		63A	22kW	64 	LTS63 PFLH4 A8	1	1,50	
		80A	22kW	64 	LTS80 PFLH4 A8	1	1,50	
	knockoutlets M50/40 +PF3/M50	on request						
	Changeover Switch with Padlock Device, lockable							
3-pole, padlock device SV4  								
 		20A	7,5kW	64 	LTS20 PFLH4 U3	1	1,39	
		25A	10kW	64 	LTS25 PFLH4 U3	1	1,39	
		32A	12,5kW	64 	LTS32 PFLH4 U3	1	1,39	
		40A	16kW	64 	LTS40 PFLH4 U3	1	1,39	
		63A	22kW	64 	LTS63 PFLH4 U3	1	1,42	
		80A	22kW	64 	LTS80 PFLH4 U3	1	1,42	
4-pole, padlock device SV4  								
 		20A	7,5kW	64 	LTS20 PFLH4 U4	1	1,44	
		25A	10kW	64 	LTS25 PFLH4 U4	1	1,44	
		32A	12,5kW	64 	LTS32 PFLH4 U4	1	1,44	
		40A	16kW	64 	LTS40 PFLH4 U4	1	1,44	
		63A	22kW	64 	LTS63 PFLH4 U4	1	1,50	
		80A	22kW	64 	LTS80 PFLH4 U4	1	1,50	

1) PFL.... larger enclosure

Emergency-Stop-Main Switches for Panel Mounting, lockable IP66, Type 3R

	max. padlocks	AC21 690V	AC23 3x400V	Plate	Type	Pack pcs.	Weighth kg/pcs.
3-pole, padlock device SV1 							
		20A	7,5kW	48 ^{□ 1)}	LTS20 EHN1 A3	1	0,15
		25A	10kW	48 ^{□ 1)}	LTS25 EHN1 A3	1	0,15
		32A	12,5kW	48 ^{□ 1)}	LTS32 EHN1 A3	1	0,15
		40A	16kW	48 ^{□ 1)}	LTS40 EHN1 A3	1	0,15
		63A	22kW	48 ^{□ 1)}	LTS63 EHN1 A3	1	0,17
		80A	22kW	48 ^{□ 1)}	LTS80 EHN1 A3	1	0,17
4-pole, padlock device SV1 							
		20A	7,5kW	48 ^{□ 1)}	LTS20 EHN1 A4	1	0,19
		25A	10kW	48 ^{□ 1)}	LTS25 EHN1 A4	1	0,19
		32A	12,5kW	48 ^{□ 1)}	LTS32 EHN1 A4	1	0,19
		40A	16kW	48 ^{□ 1)}	LTS40 EHN1 A4	1	0,19
		63A	22kW	48 ^{□ 1)}	LTS63 EHN1 A4	1	0,21
		80A	22kW	48 ^{□ 1)}	LTS80 EHN1 A4	1	0,21
3-pole, padlock device SV4(34) 							
		20A	7,5kW	64 ^{□ 2)}	LTS20 EHN4 A3	1	0,17
		25A	10kW	64 ^{□ 2)}	LTS25 EHN4 A3	1	0,17
		32A	12,5kW	64 ^{□ 2)}	LTS32 EHN4 A3	1	0,17
		40A	16kW	64 ^{□ 2)}	LTS40 EHN4 A3	1	0,17
		63A	22kW	64 ^{□ 2)}	LTS63 EHN4 A3	1	0,19
		80A	22kW	64 ^{□ 2)}	LTS80 EHN4 A3	1	0,19
		85A	30kW	64 ^{□ 2)}	LTS85 EHN4 A3	1	0,39
		100A	37kW	64 ^{□ 2)}	LTS100 EHN4 A3	1	0,39
		125A	45kW	64 ^{□ 2)}	LTS125 EHN4 A3	1	0,39
		160A	55kW	88 [□]	LT160 EHN34 T300	1	1,16
4-pole, padlock device SV4(34) 							
		20A	7,5kW	64 ^{□ 2)}	LTS20 EHN4 A4	1	0,20
		25A	10kW	64 ^{□ 2)}	LTS25 EHN4 A4	1	0,20
		32A	12,5kW	64 ^{□ 2)}	LTS32 EHN4 A4	1	0,20
		40A	16kW	64 ^{□ 2)}	LTS40 EHN4 A4	1	0,20
		63A	22kW	64 ^{□ 2)}	LTS63 EHN4 A4	1	0,23
		80A	22kW	64 ^{□ 2)}	LTS80 EHN4 A4	1	0,23
		85A	30kW	64 ^{□ 2)}	LTS85 EHN4 A4	1	0,44
		100A	37kW	64 ^{□ 2)}	LTS100 EHN4 A4	1	0,44
		125A	45kW	64 ^{□ 2)}	LTS125 EHN4 A4	1	0,44
		160A	55kW	88 [□]	LT160 EHN34 T400	1	1,55

Add-on modules see page 297

Extended Switch Shaft for switches for panel mounting



type suffix +VW"x"

x = panel thickness

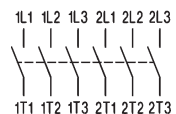

1) Types with padlock device 64 type suffix **64**, ordering example: LTS32 EHN1**64** A3, on request

2) Types with padlock device 88 type suffix **88**, ordering example: LTS32 EHN**88** A3, on request

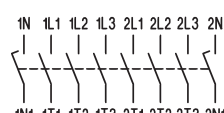

Emergency-Stop-Main Switches for Panel Mounting, lockable IP66, Type 3R

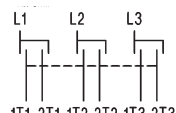
	max. padlocks	AC21 690V	AC23 3x400V	Plate	Type	Pack pcs.	Weight kg/pcs.
6-pole, padlock device SV4 							
		20A	7,5kW	64 □	LTS20 EHN4 A6	1	0,30
		25A	10kW	64 □	LTS25 EHN4 A6	1	0,30
		32A	12,5kW	64 □	LTS32 EHN4 A6	1	0,30
		40A	16kW	64 □	LTS40 EHN4 A6	1	0,30
		63A	22kW	64 □	LTS63 EHN4 A6	1	0,34
		80A	22kW	64 □	LTS80 EHN4 A6	1	0,34
8-pole, padlock device SV4 							
		20A	7,5kW	64 □	LTS20 EHN4 A8	1	0,38
		25A	10kW	64 □	LTS25 EHN4 A8	1	0,38
		32A	12,5kW	64 □	LTS32 EHN4 A8	1	0,38
		40A	16kW	64 □	LTS40 EHN4 A8	1	0,38
		63A	22kW	64 □	LTS63 EHN4 A8	1	0,42
		80A	22kW	64 □	LTS80 EHN4 A8	1	0,42

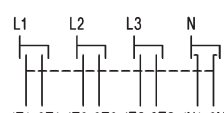
Changeover Switch with Padlock Device for Panel Mounting, lockable IP66

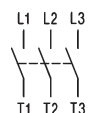

3-pole, padlock device SV4 							
		20A	7,5kW	64 □	LTS20 EHN4 U3	1	0,30
		25A	10kW	64 □	LTS25 EHN4 U3	1	0,30
		32A	12,5kW	64 □	LTS32 EHN4 U3	1	0,30
		40A	16kW	64 □	LTS40 EHN4 U3	1	0,30
		63A	22kW	64 □	LTS63 EHN4 U3	1	0,34
4-pole, padlock device SV4 							
		20A	7,5kW	64 □	LTS20 EHN4 U4	1	0,38
		25A	10kW	64 □	LTS25 EHN4 U4	1	0,38
		32A	12,5kW	64 □	LTS32 EHN4 U4	1	0,38
		40A	16kW	64 □	LTS40 EHN4 U4	1	0,38
		63A	22kW	64 □	LTS63 EHN4 U4	1	0,42

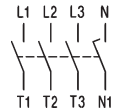
Main Switches Emergency-Stop for Single Hole Mounting, lockable IP66 Type 4X

	max. padlocks	AC21 690V	AC23 3x400V	Plate	Type	Pack pcs.	Weight kg/pcs.
3-pole, padlock device SV1 							
		20A	7,5kW	48 □	LTS20 ZHN1 A3	1	0,16
		25A	10kW	48 □	LTS25 ZHN1 A3	1	0,16
		32A	12,5kW	48 □	LTS32 ZHN1 A3	1	0,16
		40A	16kW	48 □	LTS40 ZHN1 A3	1	0,16
4-pole, padlock device SV1 							
		20A	7,5kW	48 □	LTS20 ZHN1 A4	1	0,20
		25A	10kW	48 □	LTS25 ZHN1 A4	1	0,20
		32A	12,5kW	48 □	LTS32 ZHN1 A4	1	0,20
		40A	16kW	48 □	LTS40 ZHN1 A4	1	0,20

Add-on modules see page 295

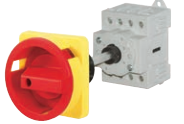
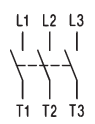
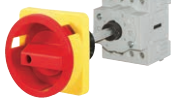
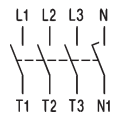
Emergency-Stop-Main Switches, Base Mounting with Door Clutch for Single-Hole Mounting
 Depth X is adjustable (delivered with X_{max} see below), IP66, cUL_{us} Type 4X

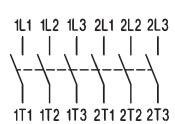
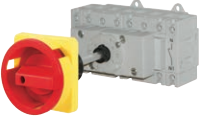
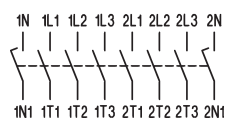
	max. padlocks	AC21 690V	AC23 3x400V	Plate	Type	Pack pcs.	Weight kg/pcs.
3-pole, padlock device SV4							
 	3	20A	7,5kW	64 □	LTS20 VZVHN4 A3	1	0,19
		25A	10kW	64 □	LTS25 VZVHN4 A3	1	0,19
		32A	12,5kW	64 □	LTS32 VZVHN4 A3	1	0,19
		40A	16kW	64 □	LTS40 VZVHN4 A3	1	0,19
		63A	22kW	64 □	LTS63 VZVHN4 A3	1	0,22
		80A	22kW	64 □	LTS80 VZVHN4 A3	1	0,22
		85A	30kW	64 □	LTS85 VZVHN4 A3	1	0,40
		100A	37kW	64 □	LTS100 VZVHN4 A3	1	0,40
		125A	45kW	64 □	LTS125 VZVHN4 A3	1	0,40
	4-pole, padlock device SV4						
 	3	20A	7,5kW	64 □	LTS20 VZVHN4 A4	1	0,20
		25A	10kW	64 □	LTS25 VZVHN4 A4	1	0,20
		32A	12,5kW	64 □	LTS32 VZVHN4 A4	1	0,20
		40A	16kW	64 □	LTS40 VZVHN4 A4	1	0,20
		63A	22kW	64 □	LTS63 VZVHN4 A4	1	0,26
		80A	22kW	64 □	LTS80 VZVHN4 A4	1	0,26
		85A	30kW	64 □	LTS85 VZVHN4 A4	1	0,45
		100A	37kW	64 □	LTS100 VZVHN4 A4	1	0,45
		125A	45kW	64 □	LTS125 VZVHN4 A4	1	0,45
	6-pole, padlock device SV4						
 	3	20A	7,5kW	64 □	LTS20 VZVHN4 A6	1	0,32
		25A	10kW	64 □	LTS25 VZVHN4 A6	1	0,32
		32A	12,5kW	64 □	LTS32 VZVHN4 A6	1	0,32
		40A	16kW	64 □	LTS40 VZVHN4 A6	1	0,32
		63A	22kW	64 □	LTS63 VZVHN4 A6	1	0,37
		80A	22kW	64 □	LTS80 VZVHN4 A6	1	0,37
8-pole, padlock device SV4							
 	3	20A	7,5kW	64 □	LTS20 VZVHN4 A8	1	0,34
		25A	10kW	64 □	LTS25 VZVHN4 A8	1	0,34
		32A	12,5kW	64 □	LTS32 VZVHN4 A8	1	0,34
		40A	16kW	64 □	LTS40 VZVHN4 A8	1	0,34
	63A	22kW	64 □	LTS63 VZVHN4 A8	1	0,45	
	80A	22kW	64 □	LTS80 VZVHN4 A8	1	0,45	

Depth
 Single Hole Mounting Ø22mm
 LTS.. VZV..

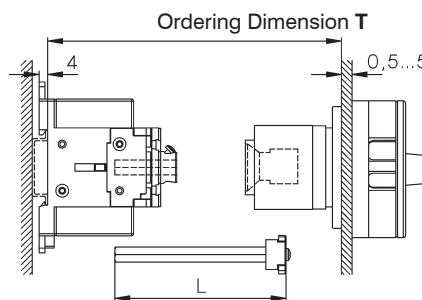
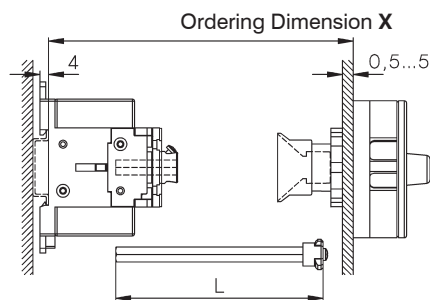

4-Hole Mounting
 LTS.. V(HN).. (3, 4-pole)





Type		X min	X max	L	Type	T min	T max	L	Type	T min	T max
LTS20-80 VZV..	3, 4-polig	91 -	190	X - 40±3	LTS20-80 VH..	111 -	190	T - 60±3	LT160 VH..	120 -	450
LTS20-80 VZV..	6, 8-polig	111 -	190	X - 60±3	LTS85-125 VH..	115 -	190	T - 64±3			
LTS85-125 VZV..	3, 4-polig	95-	190	X - 44±3							

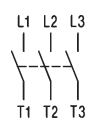

greater X- and T-Dimensions (max. 380mm for LTS..) on request

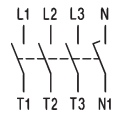
Emergency-Stop-Main Switches, Base Mounting with Door Clutch, Padlock Device for 4-Hole Mounting, Depth T is adjustable (delivered with T_{max} see page 282), IP66,  Type 4X

	max. padlocks	AC21 690V	AC23 3x400V	Schild	Type	Pack pcs.	Weight kg/pcs.	
3-pole, padlock device SV4(34)  								
			20A	7,5kW	64 ¹⁾	LTS20 VHN4 A3	1	0,20
			25A	10kW	64 ¹⁾	LTS25 VHN4 A3	1	0,20
			32A	12,5kW	64 ¹⁾	LTS32 VHN4 A3	1	0,20
			40A	16kW	64 ¹⁾	LTS40 VHN4 A3	1	0,20
			63A	22kW	64 ¹⁾	LTS63 VHN4 A3	1	0,24
			80A	22kW	64 ¹⁾	LTS80 VHN4 A3	1	0,24
			85A	30kW	64 ¹⁾	LTS85 VHN4 A3	1	0,40
			100A	37kW	64 ¹⁾	LTS100 VHN4 A3	1	0,40
			125A	45kW	64 ¹⁾	LTS125 VHN4 A3	1	0,40
		160A	55kW	88 ¹⁾	LT160 VHN34 T300	1	1,38	

4-pole, padlock device SV4(34)  			20A	7,5kW	64 ¹⁾	LTS20 VHN4 A4	1	0,21
			25A	10kW	64 ¹⁾	LTS25 VHN4 A4	1	0,21
			32A	12,5kW	64 ¹⁾	LTS32 VHN4 A4	1	0,21
			40A	16kW	64 ¹⁾	LTS40 VHN4 A4	1	0,21
			63A	22kW	64 ¹⁾	LTS63 VHN4 A4	1	0,28
			80A	22kW	64 ¹⁾	LTS80 VHN4 A4	1	0,28
			85A	30kW	64 ¹⁾	LTS85 VHN4 A4	1	0,45
			100A	37kW	64 ¹⁾	LTS100 VHN4 A4	1	0,45
			125A	45kW	64 ¹⁾	LTS125 VHN4 A4	1	0,45
			160A	55kW	88 ¹⁾	LT160 VHN34 T400	1	1,77

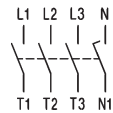
Emergency-Stop-Main Switches, Base Mounting with Door Clutch for Single-Hole Mounting Depth X is not adjustable, declare depth X when ordering, IP66,  Type 4x

4-pole, padlock device SV4  			20A	7,5kW	64 ¹⁾	LTS20 VZHN4 A4 X..	1	0,18
			25A	10kW	64 ¹⁾	LTS25 VZHN4 A4 X..	1	0,18
			32A	12,5kW	64 ¹⁾	LTS32 VZHN4 A4 X..	1	0,18
			40A	16kW	64 ¹⁾	LTS40 VZHN4 A4 X..	1	0,18
			63A	22kW	64 ¹⁾	LTS63 VZHN4 A4 X..	1	0,25
			80A	22kW	64 ¹⁾	LTS80 VZHN4 A4 X..	1	0,25

Declare depth X when ordering

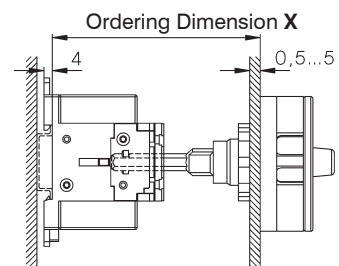

Type	Preference values for X
LTS.. VZH..	80, 85, 104, 129 (tolerance -3, +1,5)





Add-on modules see page 297



1) Types with padlock device 88 ¹⁾ type suffix **88**, ordering example: LTS32 VHN**488** A3, on request

Emergency-Stop-Main Switches for Distribution Boards, lockable IP40, Open Type

	max. padlocks	AC21 690V	AC23 3x400V	Plate	Type	Pack pcs.	Weight kg/pcs.
3-pole, padlock device SV1   		20A	7,5kW	52x45	LTS20 SMAHN1 A3 ²⁾	1	0,15
		25A	10kW	52x45	LTS25 SMAHN1 A3 ²⁾	1	0,15
		32A	12,5kW	52x45	LTS32 SMAHN1 A3 ²⁾	1	0,15
		40A	16kW	52x45	LTS40 SMAHN1 A3 ²⁾	1	0,15
		63A	22kW	52x45	LTS63 SMAHN1 A3 ²⁾	1	0,18
		80A	22kW	52x45	LTS80 SMAHN1 A3 ²⁾	1	0,18
		85A	30kW	78x45	LTS85 SMAHN1 A3	1	0,37
		100A	37kW	78x45	LTS100 SMAHN1 A3	1	0,37
		125A	45kW	78x45	LTS125 SMAHN1 A3	1	0,37

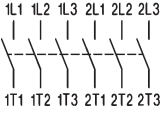

4-pole, padlock device SV1   		20A	7,5kW	52x45	LTS20 SMAHN1 A4 ²⁾	1	0,16
		25A	10kW	52x45	LTS25 SMAHN1 A4 ²⁾	1	0,16
		32A	12,5kW	52x45	LTS32 SMAHN1 A4 ²⁾	1	0,16
		40A	16kW	52x45	LTS40 SMAHN1 A4 ²⁾	1	0,16
		63A	22kW	52x45	LTS63 SMAHN1 A4 ²⁾	1	0,21
		80A	22kW	52x45	LTS80 SMAHN1 A4 ²⁾	1	0,21
		85A	30kW	78x45	LTS85 SMAHN1 A4	1	0,42
		100A	37kW	78x45	LTS100 SMAHN1 A4	1	0,42
		125A	45kW	78x45	LTS125 SMAHN1 A4	1	0,42

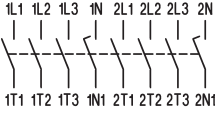
6-pole, padlock device SV1(64)   		20A	7,5kW	52x45	LTS20 SMAHN1 A6	1	0,29
		25A	10kW	52x45	LTS25 SMAHN1 A6	1	0,29
		32A	12,5kW	52x45	LTS32 SMAHN1 A6	1	0,29
		40A	16kW	52x45	LTS40 SMAHN1 A6	1	0,29
		63A	22kW	97x45	LTS63 SMAHN1 A6 ¹⁾	1	0,34
		80A	22kW	97x45	LTS80 SMAHN1 A6 ¹⁾	1	0,34

8-pole, padlock device SV164   		20A	7,5kW	97x45	LTS20 SMAHN1 A8	1	0,31
		25A	10kW	97x45	LTS25 SMAHN1 A8	1	0,31
		32A	12,5kW	97x45	LTS32 SMAHN1 A8	1	0,31
		40A	16kW	97x45	LTS40 SMAHN1 A8	1	0,31
		63A	22kW	126x45	LTS63 SMAHN1 A8	1	0,42
		80A	22kW	126x45	LTS80 SMAHN1 A8	1	0,42

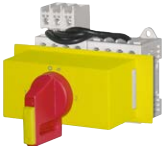
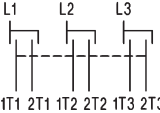
Changeover Switch with Padlock Device for Distribution Boards, lockable



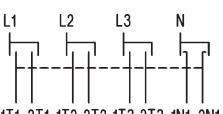







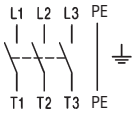

3-pole, padlock device SV164   		20A	7,5kW	97x45	LTS20 SMAHN1 U3	1	0,29
		25A	10kW	97x45	LTS25 SMAHN1 U3	1	0,29
		32A	12,5kW	97x45	LTS32 SMAHN1 U3	1	0,29
		40A	16kW	97x45	LTS40 SMAHN1 U3	1	0,29
		63A	22kW	97x45	LTS63 SMAHN1 U3	1	0,34

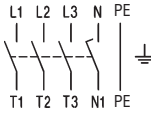
4-pole, padlock device SV164   		20A	7,5kW	97x45	LTS20 SMAHN1 U4	1	0,31
		25A	10kW	97x45	LTS25 SMAHN1 U4	1	0,31
		32A	12,5kW	97x45	LTS32 SMAHN1 U4	1	0,31
		40A	16kW	97x45	LTS40 SMAHN1 U4	1	0,31
		63A	22kW	126x45	LTS63 SMAHN1 U4	1	0,42

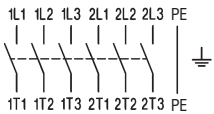
1) With padlock device SV164

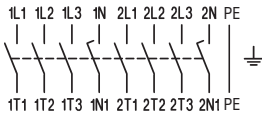

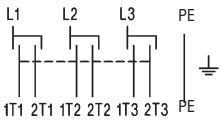

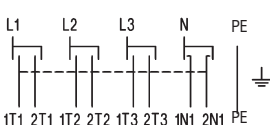



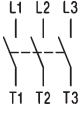

2) Emergency-Stop-Main Switches for Distribution Boards, lockable with low height handle, IP40
 Type with Type-suffix „+SV1N“ e.g.: **LTS40 SMAHN1 A3 +SV1N**

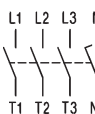
Maintenance and Safety Emergency-Stop-Main Switches, in Plastic Enclosure, lockable IP66,  us Type 4X

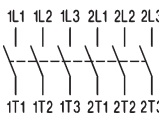

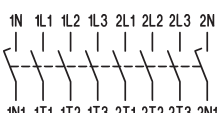
	max. padlocks	AC21 690V	AC23 3x400V	Plate	Type	Pack pcs.	Weight kg/pcs.
3-pole, padlock device SV4(34) 							
		20A	7,5kW	64 [□]	LTS20 PF(L ¹⁾)HN4 A3	1	0,32
		25A	10kW	64 [□]	LTS25 PF(L ¹⁾)HN4 A3	1	0,32
		32A	12,5kW	64 [□]	LTS32 PF(L ¹⁾)HN4 A3	1	0,32
		40A	16kW	64 [□]	LTS40 PF(L ¹⁾)HN4 A3	1	0,32
		63A	22kW	64 [□]	LTS63 PFLHN4 A3	1	0,60
		80A	22kW	64 [□]	LTS80 PFLHN4 A3	1	0,60
		Larger enclosure Type: ..PFL..	on request	85A	30kW	64 [□]	LTS85 PFLHN4 A3
		100A	37kW	64 [□]	LTS100 PFLHN4 A3	1	0,78
		125A	45kW	64 [□]	LTS125 PFLHN4 A3	1	0,78
		160A	55kW	88 [□]	LT160 PFHN34 T300	1	2,09
4-pole, padlock device SV4(34) 							
		20A	7,5kW	64 [□]	LTS20 PF(L ¹⁾)HN4 A4	1	0,33
		25A	10kW	64 [□]	LTS25 PF(L ¹⁾)HN4 A4	1	0,33
		32A	12,5kW	64 [□]	LTS32 PF(L ¹⁾)HN4 A4	1	0,33
		40A	16kW	64 [□]	LTS40 PF(L ¹⁾)HN4 A4	1	0,33
		63A	22kW	64 [□]	LTS63 PFLHN4 A4	1	0,64
		80A	22kW	64 [□]	LTS80 PFLHN4 A4	1	0,64
		Larger enclosure Type appendix +PF3	on request	85A	30kW	64 [□]	LTS85 PFLHN4 A4
		100A	37kW	64 [□]	LTS100 PFLHN4 A4	1	0,83
		125A	45kW	64 [□]	LTS125 PFLHN4 A4	1	0,83
		160A	55kW	88 [□]	LT160 PFHN34 T400	1	2,47
6-pole, padlock device SV4 							
		20A	7,5kW	64 [□]	LTS20 PFLHN4 A6	1	1,39
		25A	10kW	64 [□]	LTS25 PFLHN4 A6	1	1,39
		32A	12,5kW	64 [□]	LTS32 PFLHN4 A6	1	1,39
		40A	16kW	64 [□]	LTS40 PFLHN4 A6	1	1,39
		63A	22kW	64 [□]	LTS63 PFLHN4 A6	1	1,42
		80A	22kW	64 [□]	LTS80 PFLHN4 A6	1	1,42
		knockoutlets M50/40 +PF3/M50	on request				
8-pole, padlock device SV4 							
		20A	7,5kW	64 [□]	LTS20 PFLHN4 A8	1	1,44
		25A	10kW	64 [□]	LTS25 PFLHN4 A8	1	1,44
		32A	12,5kW	64 [□]	LTS32 PFLHN4 A8	1	1,44
		40A	16kW	64 [□]	LTS40 PFLHN4 A8	1	1,44
		63A	22kW	64 [□]	LTS63 PFLHN4 A8	1	1,50
		80A	22kW	64 [□]	LTS80 PFLHN4 A8	1	1,50
		knockoutlets M50/40 +PF3/M50	on request				
Changeover Switch with Padlock Device, lockable							
3-pole, padlock device SV4 							
		20A	7,5kW	64 [□]	LTS20 PFLHN4 U3	1	1,39
		25A	10kW	64 [□]	LTS25 PFLHN4 U3	1	1,39
		32A	12,5kW	64 [□]	LTS32 PFLHN4 U3	1	1,39
		40A	16kW	64 [□]	LTS40 PFLHN4 U3	1	1,39
		63A	22kW	64 [□]	LTS63 PFLHN4 U3	1	1,42
		80A	22kW	64 [□]	LTS80 PFLHN4 U3	1	1,42
4-pole, padlock device SV4 							
		20A	7,5kW	64 [□]	LTS20 PFLHN4 U4	1	1,44
		25A	10kW	64 [□]	LTS25 PFLHN4 U4	1	1,44
		32A	12,5kW	64 [□]	LTS32 PFLHN4 U4	1	1,44
		40A	16kW	64 [□]	LTS40 PFLHN4 U4	1	1,44
		63A	22kW	64 [□]	LTS63 PFLHN4 U4	1	1,50
		80A	22kW	64 [□]	LTS80 PFLHN4 U4	1	1,50

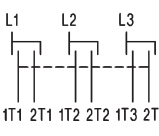
1) PFL.... larger enclosure

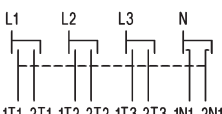



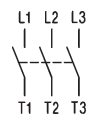

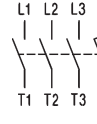
Switch Disconnectors for Panel Mounting, IP66,  Type 3R

		AC21 690V	AC23 3x400V	Plate	Type	Pack pcs.	Weight kg/pcs.
On-Off Switches 3-pole							
 	20A	7,5kW		48 □	LTS20 E A3	1	0,15
	25A	10kW		48 □	LTS25 E A3	1	0,15
	32A	12,5kW		48 □	LTS32 E A3	1	0,15
	40A	16kW		48 □	LTS40 E A3	1	0,15
	63A	22kW		48 □	LTS63 E A3	1	0,17
	80A	22kW		48 □	LTS80 E A3	1	0,17
	85A	30kW		64 □	LTS85 E A3	1	0,39
	100A	37kW		64 □	LTS100 E A3	1	0,39
	125A	45kW		64 □	LTS125 E A3	1	0,39
	160A	55kW		88 □	LT160 E T300	1	1,10
On-Off Switches 4-pole							
 	20A	7,5kW		48 □	LTS20 E A4	1	0,18
	25A	10kW		48 □	LTS25 E A4	1	0,18
	32A	12,5kW		48 □	LTS32 E A4	1	0,18
	40A	16kW		48 □	LTS40 E A4	1	0,18
	63A	22kW		48 □	LTS63 E A4	1	0,21
	80A	22kW		48 □	LTS80 E A4	1	0,21
	85A	30kW		64 □	LTS85 E A4	1	0,44
	100A	37kW		64 □	LTS100 E A4	1	0,44
	125A	45kW		64 □	LTS125 E A4	1	0,44
	160A	55kW		88 □	LT160 E T400	1	1,50
On-Off Switches 6-pole							
 	20A	7,5kW		64 □	LTS20 E A6	1	0,30
	25A	10kW		64 □	LTS25 E A6	1	0,30
	32A	12,5kW		64 □	LTS32 E A6	1	0,30
	40A	16kW		64 □	LTS40 E A6	1	0,30
	63A	22kW		64 □	LTS63 E A6	1	0,36
	80A	22kW		64 □	LTS80 E A6	1	0,36
On-Off Switches 8-pole							
 	20A	7,5kW		64 □	LTS20 E A8	1	0,32
	25A	10kW		64 □	LTS25 E A8	1	0,32
	32A	12,5kW		64 □	LTS32 E A8	1	0,32
	40A	16kW		64 □	LTS40 E A8	1	0,32
	63A	22kW		64 □	LTS63 E A8	1	0,43
	80A	22kW		64 □	LTS80 E A8	1	0,43
Changeover Switches 3-pole							
 	20A	7,5kW		64 □	LTS20 E U3	1	0,31
	25A	10kW		64 □	LTS25 E U3	1	0,31
	32A	12,5kW		64 □	LTS32 E U3	1	0,31
	40A	16kW		64 □	LTS40 E U3	1	0,31
	63A	22kW		64 □	LTS63 E U3	1	0,37
Changeover Switches 4-pole							
 	20A	7,5kW		64 □	LTS20 E U4	1	0,33
	25A	10kW		64 □	LTS25 E U4	1	0,33
	32A	12,5kW		64 □	LTS32 E U4	1	0,33
	40A	16kW		64 □	LTS40 E U4	1	0,33
	63A	22kW		64 □	LTS63 E U4	1	0,44

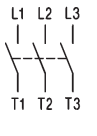
Switch Disconnectors for Single Hole Mounting, lockable IP66, c(UL)us Type 4X

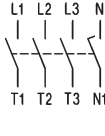
	AC21 690V	AC23 3x400V	Plate	Type	Pack pcs.	Weight kg/pcs.
On-Off Switches 3-pole						
 	20A	7,5kW	48 □	LTS20 Z A3	1	0,16
	25A	10kW	48 □	LTS25 Z A3	1	0,16
	32A	12,5kW	48 □	LTS32 Z A3	1	0,16
	40A	16kW	48 □	LTS40 Z A3	1	0,16
On-Off Switches 4-pole						
 	20A	7,5kW	48 □	LTS20 Z A4	1	0,20
	25A	10kW	48 □	LTS25 Z A4	1	0,20
	32A	12,5kW	48 □	LTS32 Z A4	1	0,20
	40A	16kW	48 □	LTS40 Z A4	1	0,20

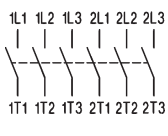
Switch Disconnectors, Base Mounting with Door Clutch for Single-Hole Mounting
Depth X is adjustable (delivered with X_{max} see page 294), IP66, c(UL)us Type 4X

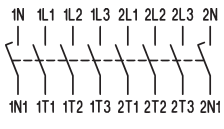
	AC21 690V	AC23 3x400V	Plate	Type	Pack pcs.	Weight kg/pcs.
On-Off Switches 3-pole						
 	20A	7,5kW	64 □	LTS20 VZV A3	1	0,19
	25A	10kW	64 □	LTS25 VZV A3	1	0,19
	32A	12,5kW	64 □	LTS32 VZV A3	1	0,19
	40A	16kW	64 □	LTS40 VZV A3	1	0,19
	63A	22kW	64 □	LTS63 VZV A3	1	0,22
	80A	22kW	64 □	LTS80 VZV A3	1	0,22
	85A	30kW	64 □	LTS85 VZV A3	1	0,40
	100A	37kW	64 □	LTS100 VZV A3	1	0,40
	125A	45kW	64 □	LTS125 VZV A3	1	0,40
	On-Off Switches 4-pole					
 	20A	7,5kW	64 □	LTS20 VZV A4	1	0,20
	25A	10kW	64 □	LTS25 VZV A4	1	0,20
	32A	12,5kW	64 □	LTS32 VZV A4	1	0,20
	40A	16kW	64 □	LTS40 VZV A4	1	0,20
	63A	22kW	64 □	LTS63 VZV A4	1	0,26
	80A	22kW	64 □	LTS80 VZV A4	1	0,26
	85A	30kW	64 □	LTS85 VZV A4	1	0,45
	100A	37kW	64 □	LTS100 VZV A4	1	0,45
	125A	45kW	64 □	LTS125 VZV A4	1	0,45
	On-Off Switches 6-pole					
 	20A	7,5kW	64 □	LTS20 VZV A6	1	0,32
	25A	10kW	64 □	LTS25 VZV A6	1	0,32
	32A	12,5kW	64 □	LTS32 VZV A6	1	0,32
	40A	16kW	64 □	LTS40 VZV A6	1	0,32
	63A	22kW	64 □	LTS63 VZV A6	1	0,37
	80A	22kW	64 □	LTS80 VZV A6	1	0,37
On-Off Switches 8-pole						
 	20A	7,5kW	64 □	LTS20 VZV A8	1	0,34
	25A	10kW	64 □	LTS25 VZV A8	1	0,34
	32A	12,5kW	64 □	LTS32 VZV A8	1	0,34
	40A	16kW	64 □	LTS40 VZV A8	1	0,34
	63A	22kW	64 □	LTS63 VZV A8	1	0,45
	80A	22kW	64 □	LTS80 VZV A8	1	0,45

Switch Disconnecter, Base Mounting with Door Clutch for Single-Hole Mounting
 Depth X is adjustable (delivered with X_{max} see below), IP66,  Type 4X

Depth
 Single Hole Mounting Ø22mm
 LTS.. VZV..

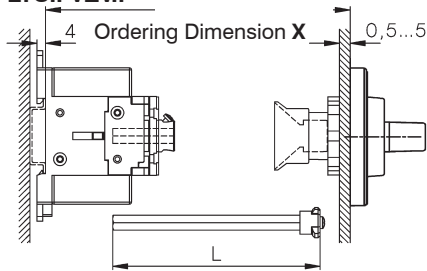



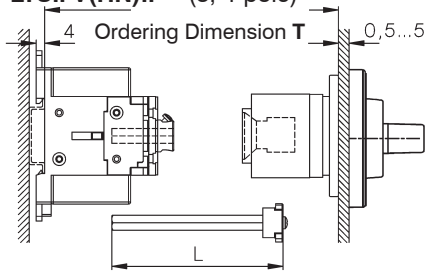

4-Hole Mounting
 LTS.. V(HN).. (3, 4-pole)



Type	X min	X max	L	Type	T min	T max	L	Type	T min	T max
LTS20-80 VZV.. 3, 4-polig	91	190	X - 40±3	LTS20-80 V..	111	190	T - 60±3	LT160 V..	120	450
LTS20-80 VZV.. 6, 8-polig	111	190	X - 60±3	LTS85-125 V..	115	190	T - 64±3			
LTS85-125 VZV.. 3, 4-polig	95	190	X - 44±3							

greater X- and T-Dimensions (max. 380mm for LTS..) on request

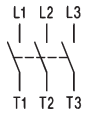
Switch Disconnecter, Base Mounting with Door Clutch for Hole Mounting
 Depth X is adjustable (delivered with T_{max} see above), IP66,  Type 4X

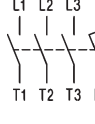
	max. padlocks	AC21 690V	AC23 3x400V	Plate	Type	Pack pcs.	Weight kg/pcs.
On-Off Switches 3-pole							
 		20A	7,5kW	64 □ 1)	LTS20 V A3	1	0,20
		25A	10kW	64 □ 1)	LTS25 V A3	1	0,20
		32A	12,5kW	64 □ 1)	LTS32 V A3	1	0,20
		40A	16kW	64 □ 1)	LTS40 V A3	1	0,20
		63A	22kW	64 □ 1)	LTS63 V A3	1	0,24
		80A	22kW	64 □ 1)	LTS80 V A3	1	0,24
		85A	30kW	64 □ 1)	LTS85 V A3	1	0,40
		100A	37kW	64 □ 1)	LTS100 V A3	1	0,40
		125A	45kW	64 □ 1)	LTS125 V A3	1	0,40
		160A	55kW	88 □	LT160 V T300	1	1,38
On-Off Switches 4-pole							
 		20A	7,5kW	64 □ 1)	LTS20 V A4	1	0,21
		25A	10kW	64 □ 1)	LTS25 V A4	1	0,21
		32A	12,5kW	64 □ 1)	LTS32 V A4	1	0,21
		40A	16kW	64 □ 1)	LTS40 V A4	1	0,21
		63A	22kW	64 □ 1)	LTS63 V A4	1	0,28
		80A	22kW	64 □ 1)	LTS80 V A4	1	0,28
		85A	30kW	64 □ 1)	LTS85 V A4	1	0,45
		100A	37kW	64 □ 1)	LTS100 V A4	1	0,45
		125A	45kW	64 □ 1)	LTS125 V A4	1	0,45
		160A	55kW	88 □	LT160 V T400	1	1,77

Add-on modules see page 297

1) Types with padlock device 88 r type suffix **88**, ordering example: LTS32 VHN488 A3, on request

Switch Disconnecter, Base Mounting with Door Clutch for Single-Hole Mounting
 Depth X is not adjustable, declare depth X when ordering, IP66, cUL_{us} Type 4X

	max. padlocks	AC21 690V	AC23 3x400V	Plate	Type	Pack pcs.	Weight kg/pcs.
On-Off Switches 4-pole							
		20A	7,5kW	64 □	LTS20 VZ A4 X..	1	0,18
		25A	10kW	64 □	LTS25 VZ A4 X..	1	0,18
		32A	12,5kW	64 □	LTS32 VZ A4 X..	1	0,18
		40A	16kW	64 □	LTS40 VZ A4 X..	1	0,18
		63A	22kW	64 □	LTS63 VZ A4 X..	1	0,25
		80A	22kW	64 □	LTS80 VZ A4 X..	1	0,25

Declare depth X when ordering

Type	Preference values for X
LTS.. VZ..	80, 85, 104, 129 (tolerance -3, +1,5)

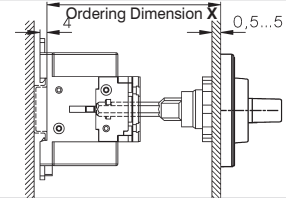

Add-on modules see page 297

Switch Disconnectors for Distribution Boards, IP40, cUL_{us} Open Type

On-Off Switches 3-pole							
		20A	7,5kW	52x45	LTS20 SMA A3	1	0,15
		25A	10kW	52x45	LTS25 SMA A3	1	0,15
		32A	12,5kW	52x45	LTS32 SMA A3	1	0,15
		40A	16kW	52x45	LTS40 SMA A3	1	0,15
		63A	22kW	52x45	LTS63 SMA A3	1	0,17
		80A	22kW	52x45	LTS80 SMA A3	1	0,17
	85A	30kW	78x45	LTS85 SMA A3	1	0,37	
	100A	37kW	78x45	LTS100 SMA A3	1	0,37	
	125A	45kW	78x45	LTS125 SMA A3	1	0,37	

On-Off Switches 4-pole							
		20A	7,5kW	52x45	LTS20 SMA A4	1	0,16
		25A	10kW	52x45	LTS25 SMA A4	1	0,16
		32A	12,5kW	52x45	LTS32 SMA A4	1	0,16
		40A	16kW	52x45	LTS40 SMA A4	1	0,16
		63A	22kW	52x45	LTS63 SMA A4	1	0,21
		80A	22kW	52x45	LTS80 SMA A4	1	0,21
	85A	30kW	78x45	LTS85 SMA A4	1	0,42	
	100A	37kW	78x45	LTS100 SMA A4	1	0,42	
	125A	45kW	78x45	LTS125 SMA A4	1	0,42	

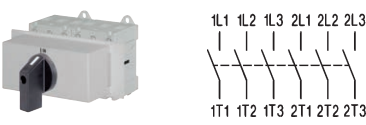

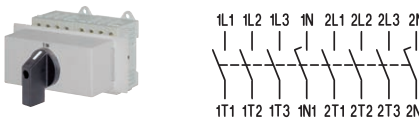

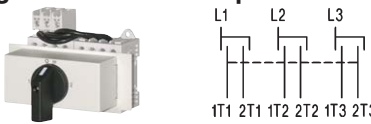

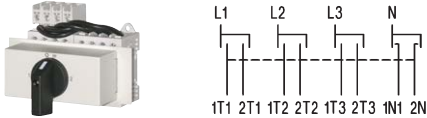

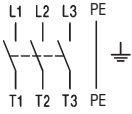

On-Off Switches 6-pole							
		20A	7,5kW	52x45	LTS20 SMA A6	1	0,29
		25A	10kW	52x45	LTS25 SMA A6	1	0,29
		32A	12,5kW	52x45	LTS32 SMA A6	1	0,29
		40A	16kW	52x45	LTS40 SMA A6	1	0,29
		63A	22kW	97x45	LTS63 SMA A6	1	0,34
		80A	22kW	97x45	LTS80 SMA A6	1	0,34

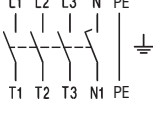
On-Off Switches 8-pole							
		20A	7,5kW	97x45	LTS20 SMA A8	1	0,31
		25A	10kW	97x45	LTS25 SMA A8	1	0,31
		32A	12,5kW	97x45	LTS32 SMA A8	1	0,31
		40A	16kW	97x45	LTS40 SMA A8	1	0,31
		63A	22kW	126x45	LTS63 SMA A8	1	0,42
		80A	22kW	126x45	LTS80 SMA A8	1	0,42

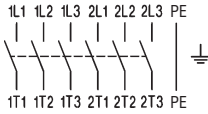
Changeover Switches 3-pole							
		20A	7,5kW	97x45	LTS20 SMA U3	1	0,30
		25A	10kW	97x45	LTS25 SMA U3	1	0,30
		32A	12,5kW	97x45	LTS32 SMA U3	1	0,30
		40A	16kW	97x45	LTS40 SMA U3	1	0,30
		63A	22kW	97x45	LTS63 SMA U3	1	0,35

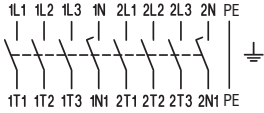

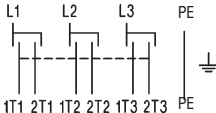

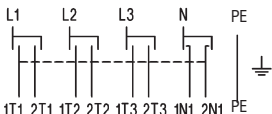



Changeover Switches 4-pole							
		20A	7,5kW	97x45	LTS20 SMA U4	1	0,32
		25A	10kW	97x45	LTS25 SMA U4	1	0,32
		32A	12,5kW	97x45	LTS32 SMA U4	1	0,32
		40A	16kW	97x45	LTS40 SMA U4	1	0,32
		63A	22kW	126x45	LTS63 SMA U4	1	0,43

Switch Disconnectors in Plastic Enclosure IP66, Type 4X



	AC21 690V	AC23 3x400V	Plate	Type	Pack pcs.	Weight kg/pcs.
On-Off Switches 3-pole  	20A	7,5kW	64 □	LTS20 PF(L ¹) A3	1	0,30
	25A	10kW	64 □	LTS25 PF(L ¹) A3	1	0,30
	32A	12,5kW	64 □	LTS32 PF(L ¹) A3	1	0,30
	40A	16kW	64 □	LTS40 PF(L ¹) A3	1	0,30
	63A	22kW	64 □	LTS63 PFL A3	1	0,58
	80A	22kW	64 □	LTS80 PFL A3	1	0,58
On-Off Switches 4-pole  	20A	7,5kW	64 □	LTS20 PF(L ¹) A4	1	0,31
	25A	10kW	64 □	LTS25 PF(L ¹) A4	1	0,31
	32A	12,5kW	64 □	LTS32 PF(L ¹) A4	1	0,31
	40A	16kW	64 □	LTS40 PF(L ¹) A4	1	0,31
	63A	22kW	64 □	LTS63 PFL A4	1	0,62
	80A	22kW	64 □	LTS80 PFL A4	1	0,62
On-Off Switches 6-pole  	20A	7,5kW	64 □	LTS20 PFL A6	1	1,39
	25A	10kW	64 □	LTS25 PFL A6	1	1,39
	32A	12,5kW	64 □	LTS32 PFL A6	1	1,39
	40A	16kW	64 □	LTS40 PFL A6	1	1,39
	63A	22kW	64 □	LTS63 PFL A6	1	1,42
	80A	22kW	64 □	LTS80 PFL A6	1	1,42
knockoutlets M50/40 +PF3/M50 on request						
On-Off Switches 8-pole  	20A	7,5kW	64 □	LTS20 PFL A8	1	1,44
	25A	10kW	64 □	LTS25 PFL A8	1	1,44
	32A	12,5kW	64 □	LTS32 PFL A8	1	1,44
	40A	16kW	64 □	LTS40 PFL A8	1	1,44
	63A	22kW	64 □	LTS63 PFL A8	1	1,50
	80A	22kW	64 □	LTS80 PFL A8	1	1,50
knockoutlets M50/40 +PF3/M50 on request						
Changeover Switches 3-pole  	20A	7,5kW	64 □	LTS20 PFL U3	1	1,39
	25A	10kW	64 □	LTS25 PFL U3	1	1,39
	32A	12,5kW	64 □	LTS32 PFL U3	1	1,39
	40A	16kW	64 □	LTS40 PFL U3	1	1,39
	63A	22kW	64 □	LTS63 PFL U3	1	1,42
	80A	22kW	64 □	LTS80 PFL U3	1	1,42
Changeover Switches 4-pole  	20A	7,5kW	64 □	LTS20 PFL U4	1	1,44
	25A	10kW	64 □	LTS25 PFL U4	1	1,44
	32A	12,5kW	64 □	LTS32 PFL U4	1	1,44
	40A	16kW	64 □	LTS40 PFL U4	1	1,44
	63A	22kW	64 □	LTS63 PFL U4	1	1,50
	80A	22kW	64 □	LTS80 PFL U4	1	1,50

1) PFL.... larger enclosure













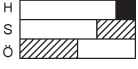

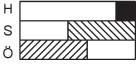
Add-on Modules for Main Switches, Panel Mounting and Single Hole Mounting

	for switch	Type	Pack pcs.	Weight kg/pcs.	
	4th Add-on Neutral Switching Pole N N1	LTS20 ... to LTS40 ... LTS63 ... , LTS80 ...	N40E N80E	1 1	0,035 0,042
	Aux. Contact Block 1NO + 1NC H S O 13 21 14 22	LTS20 ... to LTS125 ...	LH11	1	0,02
	Aux. Contact Block 1NO + 1NC Overlapping H S O 47 35 48 36	LTS20 ... to LTS125 ...	LH11X	1	0,02
	Aux. Contact Block 2NC H O O 11 21 12 22	LTS20 ... to LTS125 ...	LH20V/02E	1	0,02
	PE-Terminal PE PE	LTS20 ... to LTS80 ... LT125 E.. to LT160 E..	PE80E LTXX-E/E	1 1	0,04 0,2
	N-Terminal N N	LTS20 ... to LTS80 ... LT125 E.. to LT160 E..	PEN80E LTXX-N/E	1 1	0,04 0,2
	Terminal Cover 3-pole	LTS20 ... to LTS80 ... LTS85.. to LTS125. LT125.. to LT160..	KLAD70 KLAD125 XX-KLAD3	1 1 1	0,005 0,01 0,02
	Terminal Cover for 4th pole	Mains Load circuit	LTS20 ... to LTS80.. LTS20 ... to LTS80.. KLAD70N KLAD70NI	1 1	0,002 0,002
	Terminal Cover 4-pole	LTS85.. to LTS125. LT125.. to LT160..	KLAD125 XX-KLAD4	1 1	0,01 0,02

Accessories for Main Switches, Panel Mounting, Single Hole and Base Mounting

	for switch	Type	Pack pcs.	Weight kg/pcs.		
	Additional Escutcheon Plate Yellow, Marked with: HAUPTSCHALTER	for plate 48 ^r for plate 64 ^r	LTS.. .HN1.. LTS.. .HN4..	A91501 E91501	1 1	0,003 0,005
	Additional Escutcheon Plate Yellow, Marked with: MAIN SWITCH	for plate 48 ^r for plate 64 ^r	LTS.. .HN1.. LTS.. .HN4..	A91524 E91524	1 1	0,003 0,005
	Tab Terminal 6,3 x 0,8mm	LTS20 ... bis LTS40 ...	LG11073	10	0,001	

Add-on Modules for Main Switches, Base and Rail Mounting

		for switch	Type	Pack pcs.	Weight kg/pcs.	
	4th Add-on Neutral Switching Pole					
		LTS20 ... , LTS40 ... LTS63 ... , LTS80 ...	N40V N80V	1 1	0,035 0,042	
	Aux. Contact Block 1NO + 1NC					
		LTS20 ... to LTS125 ...	LH11	1	0,02	
	Aux. Contact Block 1NO + 1NC Overlapping					
		LTS20 ... to LTS125 ...	LH11X	1	0,02	
	Aux. Contact Block 2NO					
		LTS20 ... to LTS80 ...	LH20V/02E	1	0,02	
	PE-Terminal					
		LTS20 ... to LTS80 ... LT125 .. to LT160 .. LTXE-E/V	PE80V	1 1	0,04 0,2	
	N-Terminal					
		LTS20 ... to LTS80 ... LT125 .. to LT160 .. LTXE-N/V	PEN80V	1 1	0,04 0,2	
	Terminal Cover 3-pole					
		LTS20 ... to LTS40 ...	KLAD40	1	0,005	
		LTS63 ... to LTS80 ...	KLAD70	1	0,005	
		LTS85.. to LTS125.	KLAD125	1	0,01	
		LT125.. to LT160..	XX-KLAD3	1	0,02	
	Terminal Cover for 4th pole					
	Mains Load circuit	LTS63.., LTS80.. LTS63.., LTS80..	KLAD70N KLAD70NI	1 1	0,002 0,002	
	Terminal Cover 4-pole					
		LTS20 ... to LTS40 ...	KLAD40	1	0,005	
		LTS85.. to LTS125.	KLAD125	1	0,01	
		LT125.. to LT160..	XX-KLAD4	1	0,02	
	Additional Cover SMA for					
	4. Pole	N40V, N80V	grey	LG8628-2	1	0,047
	Aux. Contacts PE and N-Terminal	LH.. PE80V, PEN80V	yellow	LG8628-7	1	0,047

Technical Data

Data according to IEC 947-3, IEC 947-5-1, VDE 0660, EN 60947-3, EN 60947-5-1

Type	LTS20	LTS25	LTS32	LTS40	LTS63	LTS80	LTS85	LTS100	LTS125	LT160		
Main contacts												
Rated thermal current I_{th} open	A	20	25	32	40	63	80	85	100	125	160	
Rated thermal current I_{the} enclosed	A	20	25	32	40	63	80	85	100	110	160	
Rated insulation voltage U_i 1)	V	690	690	690	690	690	690	1000 ⁵⁾	1000 ⁵⁾	1000 ⁵⁾	1000 ³⁾	
Rated operational current I_e AC21A	A	20	25	32	40	63	80	85	100	125	160	
Making capacity I_{eff} 3x380-440V	A	160	190	220	300	370	440	600	725	850	1050	
Breaking capacity 3x220-240V	A	160	180	200	250	330	380	480	580	680	900	
	A	160	180	200	250	330	380	480	580	680	850	
	A	80	110	140	170	190	220	250	330	420	340	
Disconnection property performed up to	V	690	690	690	690	690	690	1000	1000	1000	1000 ³⁾	
Motor Switch AC3 3x400V	A	12	16	23	30	37	37	45	60	72	85	
Motor Switch AC3 3x220-240V	kW	3	4	5,5	7,5	11	11	15	18,5	22	30	
Direct switching of single motors 3x380-440V	kW	5,5	7,5	11	15	18,5	18,5	22	30	37	45	
	kW	5,5	7,5	11	15	18,5	18,5	18,5	22	30	37	
Main Switch AC23 3x400V	A	16	20	25	32	45	45	60	72	85	110	
Motor Switch, AC23A, 3x220-240V	kW	4	5,5	7,5	9	15	15	18,5	22	30	30	
Main Switch, AC23B 3x380-440V	kW	7,5	10	12,5	16	22	22	30	37	45	55	
Safety Switch 3x660-690V	kW	5,5	7,5	11	15	18,5	18,5	22	30	37	37	
Rated conditional short-circuit current kA_{eff}	10	10	10	10	10	10	10	10	10	5	30	
Max. fuse size gL (gG)	A	25	35	40	40	63	80	100	100	125	160	
Mechanical life $\times 10^3$	200	200	200	200	100	100	100	100	100	100	100	
Rated short-time withstand current (1sec. current)	A	250	300	400	500	600	850	1000	1200	1500	3000	
Power loss per pole AC21 = I_{th}	P/pole [W]	E, Z	0,322	0,503	0,824	1,288	2,739	4,416	3,851	5,330	8,328	
		V, SMA, PF	0,364	0,569	0,933	1,458	2,739	4,416	3,851	5,330	8,328	
		R/pole [mOhm]	E, Z	0,805	0,805	0,805	0,805	0,690	0,690	0,533	0,533	0,533
			V, SMA, PF	0,911	0,911	0,911	0,911	0,690	0,690	0,533	0,533	0,533
Maximum ambient temperature												
Operation	open	-40°C to +60°C										
	enclosed	-40°C to +40°C										
Storage		-50°C to +90°C										
Cable cross sections												
solid or stranded	mm ²	0,5 - 10			1 - 25 ⁶⁾			4 - 50		max.95		
	AWG	20 - 8 (10)			16 - 4 (10)			12 - 00 (10)		max.3/0		
flexible	mm ²	0,5 - 6			4 - 16 ⁶⁾			10 - 35		max.70		
	AWG	20 - 10			16 - 6			8 - 2		max.2/0		
flexible (+ multicore cable end)	mm ²	0,5 - 6			0,75 - 16 ⁶⁾			6 - 35		max.50		
	AWG	20 - 10			16 - 6			8 - 2		max.1/0		
Size of terminal screw		M3,5			M5			M6		M10		
Tightening torque	Nm	1,7 - 2,3			2,8 - 4			1,7 - 4,5		14		
Auxiliary contacts												
Rated insulation voltage U_i 1)	V	690			690			690		690		
Rated thermal current I_{th} , I_{the}	A	10			10			10		16		
Switching capacity AC15 380-450V	A	2,5/1,5			2,5/1,5			2,5/1,5		6/4		
	A	2/0,4			2/0,4			2/0,4		-		
Rated conditional short-circuit current kA_{eff}	3	3			3			3		3		
	A	10			10			10		16		
Cable cross sections												
solid or stranded	mm ²	0,75 - 2,5			0,75 - 2,5			0,75 - 2,5		max.4		
	AWG	14 - 12			14 - 12			14 - 12		max.12		
flexible (+ multicore cable end)	mm ²	0,75 - 2,5 (1,5)			0,75 - 2,5 (1,5)			0,75 - 2,5 (1,5)		max.2,5		
	AWG	18 - 14			18 - 14			18 - 14		max.14		
Data according to UL and cUL												
Type	LTS20	LTS25	LTS32	LTS40	LTS63	LTS80	LTS85	LTS100	LTS125	LT160		
Rated voltage	V	600	600	600	600	600	600	600	600	600		
Ampere-Rating "General use"	A	20	25	32	40	63	80	85	100	125		
DOL-Rating 3-phase	110-120V	HP	1	1,5	2	2	3	5	7,5	10	15	
	220-240V	HP	3	5	5	5	10	10	20	25	30	
	440-480V	HP	7,5	10	10	10	20	20	40	50	60	
	550-600V	HP	10	10	15	15	25	25	50	60	60	
DOL-Rating 1-phase	110-120V	HP	1	1	1	1	2	2	3	5	7,5	
	200-208V	HP	1	2	2	2	3	3	7,5	10	10	
	220-240V	HP	2	2	3	3	5	5	10	15	15	
Fuse size (RK5) Manual Motor Controller	A	40	50	50	70	90	110	125	125	125	400 ⁴⁾	
5kA / 600V Motor Disconnect	A	40	50	50	50	70	70	125	125	125	400 ⁴⁾	
Tightening torque	Nm	1,7-2,3	1,7-2,3	1,7-2,3	1,7-2,3	2,8-4	2,8-4	1,7-4,5	1,7-4,5	1,7-4,5	14	
	lb.inch	15-20	15-20	15-20	15-20	25-35	25-35	15-40	15-40	15-40	124	

1) suitable for: earthed-neutral systems, overvoltage category I to III, pollution degree 3 (standard-industry): $U_{imp} = 6kV$.

2) the values after the slash are valid for switches 6-pole or more

3) Suitable for no load applications(AC20A) above 690V

4) Fuse RK1 / 10kA / 600V

5) $U_{imp} = 8kV$

6) LTS63..U. stranded 16mm², flexible 10mm²

Dimensions (mm)

Main Switches, Switch Disconnectors LT(S)..

Panel mounting LT(S).. E(HN)..
ON-OFF Switches 3-pole, 4-pole

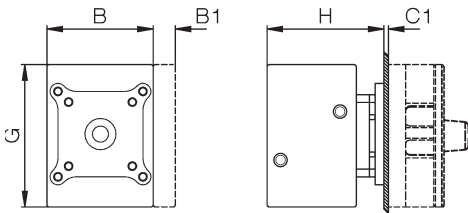

ON-OFF Switches 6-pole, 8-pole
Changeover Switches 3-pole, 4-pole

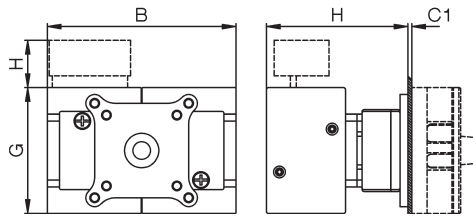

Mounting holes
Mounting screw: J3631N M=1,2-1,4 Nm

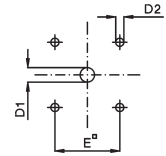

Single hole mounting LTS.. Z(HN)..
ON-OFF Switches 3-pole, 4-pole

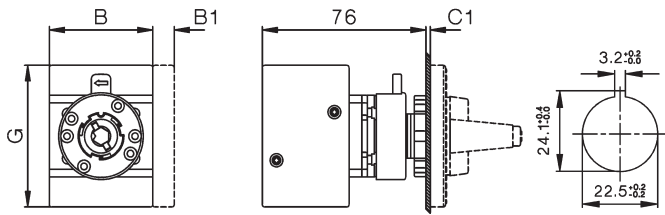

Mounting holes

Mounting of add-on modules LTS20 - LTS80
Panel mounting, Single hole mounting

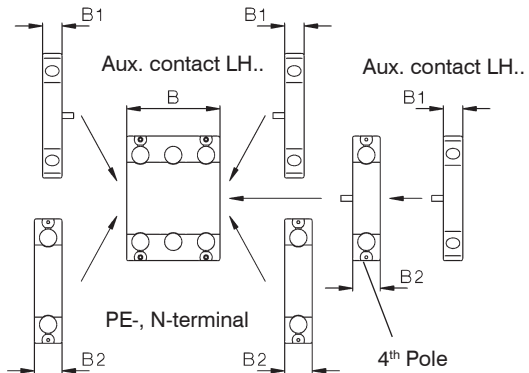

Type	Changeover ON-OFF Escutch. plate or padlock device	3-pole		4-pole		aux. contact B1	4 Pole				3,4-pole						
		A	B	B	B		B	PE B2	C1	D1	D2	E	F	G	3-pole 4-pole X	6-pole 8-pole X	H
LTS20-80..	48 □, SV1	48	48	62,5	-	-	10	14,5	1-5	9	5	36	-	64	54	-	24
LTS20-80..	64 □, SV4, SV164	64	48	62,5	97	126	10	14,5	1-5	9	5	48	-	64	54	74	24
LTS85-125..	64 □, SV4	64	78	78	-	-	10	-	1-5	9	5	48	-	85	60	-	-
LTS85-125..	88 □, SV488	88	78	78	-	-	10	-	1-5	9	6	68	-	85	60	-	-
LT160	88 □, SV34	88	112	150	224	-	-	-	1-4	13-17	6	68	49,3	108	96	98	-

Escutcheon plate
48 □

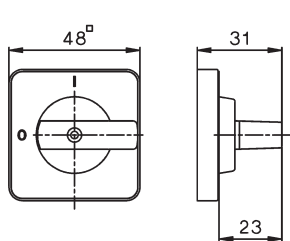

64 □

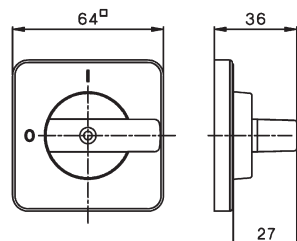

Padlock devices
SV1

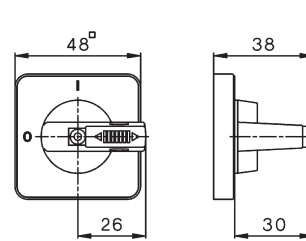

SV164

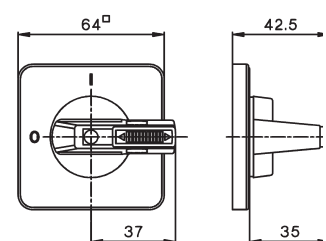

Padlock devices
SV4

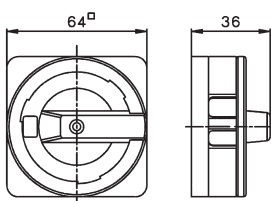

SV488

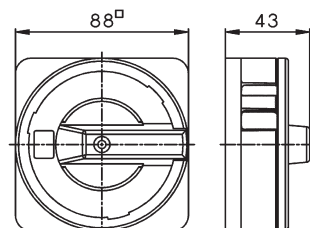

SV34

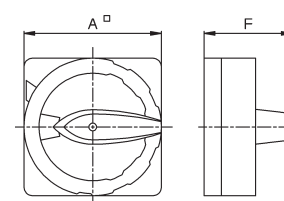

Extended Switch Shaft
+VW"x"

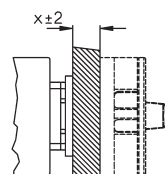

Dimensions (mm)

Main Switches, Switch Disconnectors LT(S)..

Base mounting LTS.. VZV(HN)..
ON-OFF Switches 3-pole, 4-pole

$L = X - 40 \pm 3$ for LTS20 - 80
 $L = X - 44 \pm 3$ for LTS85 - 125

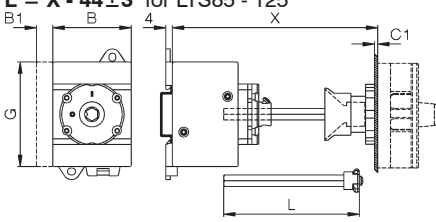

6-pole
for LTS20 - 40 only
 $L = X - 40 \pm 3$

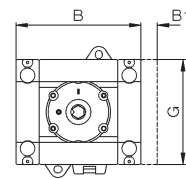

ON-OFF Switches 6-pole, 8-pole
Changeover Switches 3-pole, 4-pole
 $L = X - 60 \pm 3$

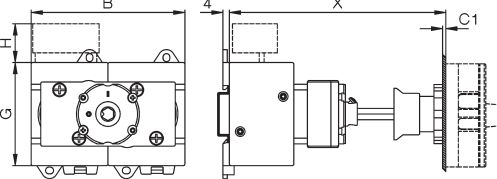

Mounting holes

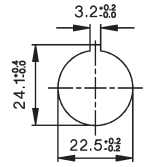

Base mounting LT(S).. V(HN)..
ON-OFF Switches 3-pole, 4-pole

$L = T - 60 \pm 3$ for LTS20 - 80
 $L = T - 64 \pm 3$ for LTS85 - 125

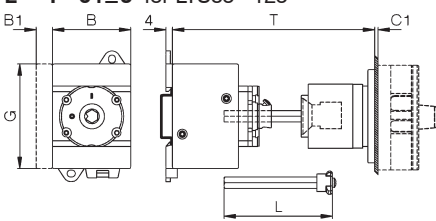

6-pole
for LTS20 - 40 only
 $L = T - 60 \pm 3$

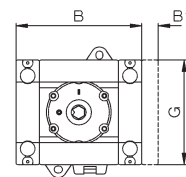

ON-OFF Switches 6-pole, 8-pole
Changeover Switches 3-pole, 4-pole
 $L = T - 80 \pm 3$ for LTS20 - 80 only

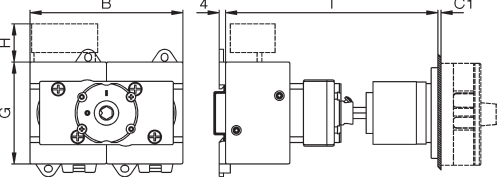

Mounting holes

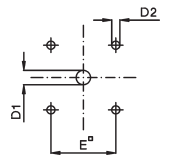

Base mounting LTS.. VZ(HN)..
ON-OFF Switches 3-pole, 4-pole

Preference values for X: 80, 85, 104, 129

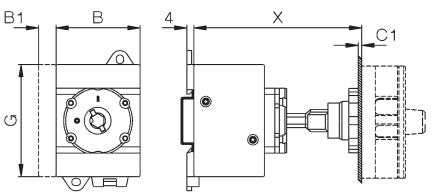

6-pole
for LTS20 - 40 only

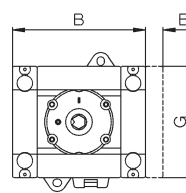

ON-OFF Switches 6-pole, 8-pole
Changeover Switches 3-pole, 4-pole

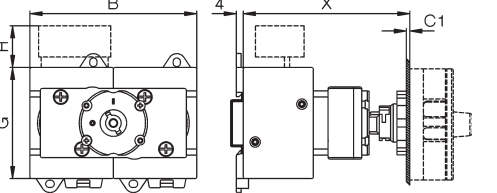

Mounting holes

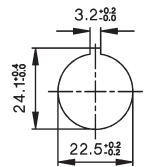

Type	Changeover ON-OFF Escutch. plate or padlock device	3,4-pole					aux. contact B1	4 Pole PE		C1	D1	D2	D3	E	G	K	K1	J
		A	B	B	B	B		B2	H									
LTS20 -40	64 [□] , SV4, SV164	64	48	48	77	97	10	14,5	24	1-5	9	5	M4	48	64	25	48	70
LTS63, 80	64 [□] , SV4, SV164	64	48	62,5	97	126	10	14,5	24	1-5	9	5	M4	48	64	25	48	70
LTS85-125..	64 [□] , SV4	64	78	78	-	-	10	-	-	1-5	9	5	M4	48	85	38	-	90
LT125/160	88 [□] , SV34	88	112	150	224	-	-	-	-	1-4	13/27 ²⁾	6	M6	68	108	36	-	120

Base mounting
ON-OFF Switches LTS20 - LTS80

3-pole, 4-pole
6-pole LTS20 -40
6-pole, 8-pole
Changeover Switches

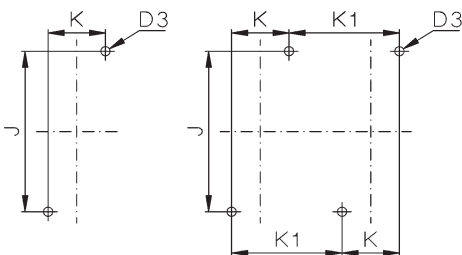

LTS85-125, LT160
3-pole, 4-pole

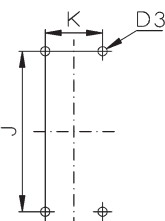

Mounting of Accessories LTS20 - LTS80

Base mounting, for distribution boards

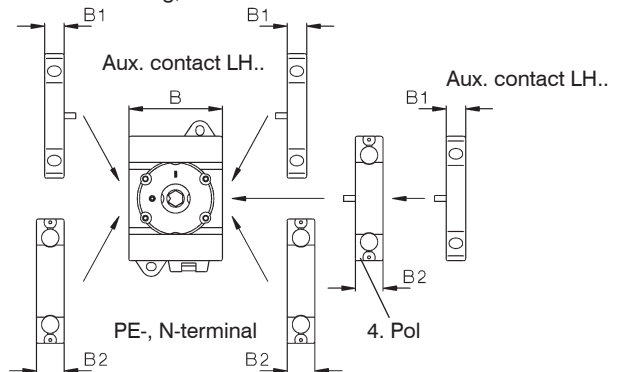

1) Ø 22-25 for LT80(100) VH(N)34 .. only
2) Ø 26-30 for LT125(160) VH(N)34 .. only

Dimensions (mm)

Main Switches, Switch Disconnectors LT(S)..

Installation cover LT(S).. SMA(HN)..

ON-OFF Switches 3-pole, 4-pole

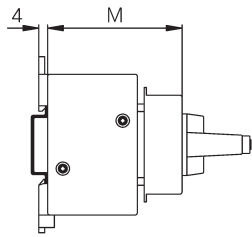
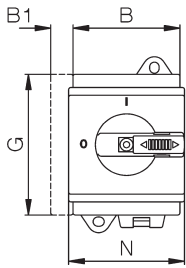

ON-OFF Switches 6-pole
for LTS20 - 40 only

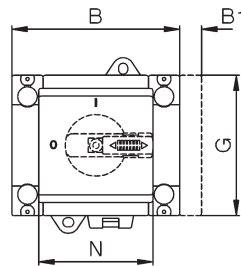

ON-OFF Switches 6-pole, 8-pole
Changeover Switches 3-pole, 4-pole

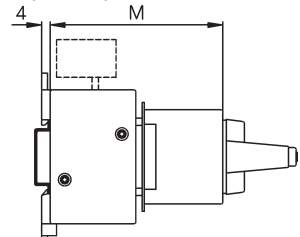
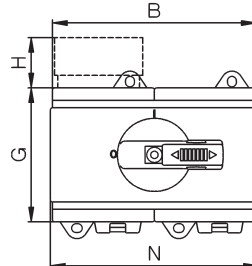

Type	padlock device	Changeover ON-OFF						G	3,4-pole			3,4-pole			H
		3-pole	4-pole	6-pole	8-pole	aux. contact	4.pole PE		3-pole 4-pole	6-pole	8-pole	3-pole 4-pole	6-pole	8-pole	
		B	B	B	B	B1	B2	M		M	M	N	N	N	
LTS20 - 40	SV1, SV164	48	48	77	96	10	14,5	64	60	60	74	52	52	97 ²⁾	24
LTS63, 80	SV1, SV164	48	62,5	96	125	10	14,5	64	60	74	74	52	97 ²⁾	126 ¹⁾	
LTS85-125..	SV164	78	78	-	-	10	-	85	60	-	-	78	-	-	

Installation cover with low height handle LTS SMAHN1.. +SV1N

Main switch 3-pole, 4-pole

LTS20 - LTS80

Padlock device SV1

Padlock device SV164

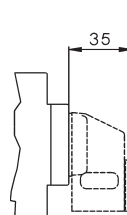
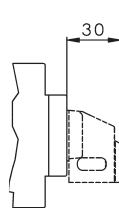
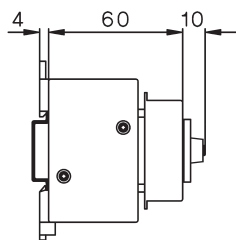
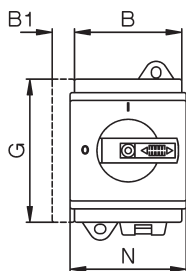

1) Original cover

2) Remove cover parts

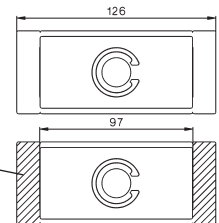

Maintenance and Safety Switches LT(S)..PF.

Type	pole	size	A	B	C	D1	D2	E	F	H
LTS20 PFH.. A. - LTS40 PFH.. A. ³⁾	3, 4	PF1	130	98	120	2x25,5/20,5	-	75	100	76
LTS20 PFLH.. A., LTS40 PFLH A. ³⁾	3, 4	PFL	180	98	170	2x25,5/20,5 / 16,5/12,5-	-	75	150	76
LTS20 PFLH.. A. - LTS40 PFLH.. A. ⁴⁾	6	PFL2	200	140	188,5	40,5/32,5+16,5+12,5	-	100	160	86
LTS63 PFLH.. A. - LTS80 PFLH.. A. ⁴⁾	3, 4	PFL2	200	140	188,5	40,5/32,5+16,5+12,5	-	100	160	86
+ PF3	3, 4	PFL3	240	176	228,5	2x40,5/32,5	-	120	200	120
+ PF3/M50	3, 4	PFL3	240	176	228,5	50,5/40,5	-	120	200	120
LTS85 PFLH.. A. - LTS125 PFLH..A. ⁴⁾	3, 4	PFL2	200	140	188,5	40,5/32,5+16,5+12,5	-	100	160	86
LTS20 PFLH.. A. - LTS40 PFLH.. A. ⁵⁾	8	PFL3	240	176	228,5	2x40,5/32,5	-	120	200	120
LTS63 PFLH.. A. - LTS80 PFLH.. A. ⁵⁾	6, 8	PFL3	240	176	228,5	2x40,5/32,5	-	120	200	120
LTS85 PFLH.. A. - LTS125 PFLH..A. ⁵⁾	3, 4	PFL3	240	176	228,5	50,5/40,5	-	120	200	120
LT160 PF..	3	PF4	300	200	-	2x50,5	25,5	172	272	172
LT160 PF..	4	PF5	300	280	-	2x50,5	-	254	254	180

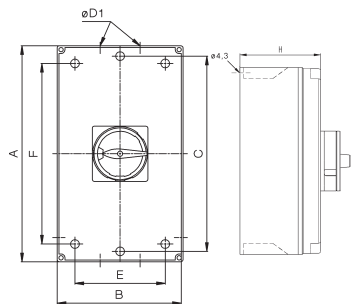

Switch Disconnectors in Plastic Enclosure LTS..PF.

Type	pole	size	A	B	C	D1	E	F	H
LTS20 PF A., LTS40 PF A. ³⁾	3, 4	PF1	130	98	121	2x25,5/20,5	75	100	76
LTS20 PFL A., LTS40 PFL A. ³⁾	3, 4	PFL	180	98	170	2x25,5/20,5 / 16,5/12,5	75	150	76
LTS63 PFL A., LTS80 PFL A. ⁴⁾	3, 4	PFL2	200	140	188,5	40,5/32,5+16,5+12,5	100	160	86
+ PF3	3, 4	PFL3	240	176	228,5	2x40,5/32,5	120	200	120
+ PF3/M50	3, 4	PFL3	240	176	228,5	50,5/40,5	120	200	120

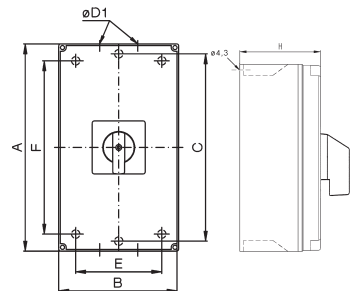

Max. quantity of poles + aux. contacts in enclosure:

3) LTS40 PF. A5 + LH11

4) LTS40 PFL.. A6, LTS80 PFL.. A5 + LH11, LTS125 PFL.. A4 + LH11

5) LTS40 PFL.. A10, LTS40 PFL.. U4 + LH11, LTS80 PFL.. A8, LTS80 PFL.. A6 + LH11, LTS80 PFL.. U4, LTS40 PFL.. U3 + LH11, LTS125 PFL.. A4+LH11