

Operating Manual UPS Systems

JOVYATLAS POWERMASTER S1002



BAX 3006 E

NOTES!

Notes concerning this operating manual

Thank you for deciding to purchase this uninterrupted power supply unit (UPS) Type **JOVYATLAS POWERMASTER S 1002**. It represents reliable protection for the attached consumers.

Please read through this manual very carefully

This manual contains regulations covering safety, installation and operating methods which will help you guarantee to obtain the full performance and operational readiness which the UPS can offer.

Put this manual in a place of safe keeping

It contains important regulations for safe use of this UPS and for reaching manufacturer services if, for some reason, correct operation of the UPS is in doubt.

Keep or reuse the packaging material

The packaging material for the UPS was designed with great care to protect its contents against damage during transport. This material is also useful if you ever have to send the UPS back for checking. Damage which occurs during transport is not covered by the warranty provisions.

Duty to instruct persons

This operating manual is to be read through carefully before assembly and first use of the UPS by persons who will be working with or on the UPS.

This operating manual is an integral part of the UPS. The operator of this device is required to make this operating manual available in an unlimited fashion to every group of persons who transport the UPS, commission it, maintain it or who do any other kind of work on this device.

Validity

This operating manual is in line with state-of-the-art UPS technology at its time of publishing. The contents are not part of the contract but simply serve as a source of information.

JOVYATLAS reserves the right to make any necessary changes to the contents and technology described in this operating manual without having to make an announcement to this effect. **JOVYATLAS** cannot be held responsible for any errors or improper information in this operating manual since there is no duty upon the company to update this operating manual on an ongoing basis.

Loss of warranty

Our deliveries and services rendered are subject to the General Delivery Conditions for Products of the Electrical Industry as well as our General Sales Conditions. We reserve full rights to make any changes to this operating manual, in particular to technical data, operation, dimensions and weights. We request that you make any claims concerning delivered goods within eight days after arrival of the goods together with the packing slip. Complaints made later than this cannot be considered.

JOVYATLAS will annul all duties upon **JOVYATLAS** and its dealers such as promises to offer a warranty period, service contracts etc. without warning if any spare parts other than original **JOVYATLAS** parts or parts bought from **JOVYATLAS** are used for maintenance and repair purposes.

Handling

This operating manual for the UPS is constructed in such a way that all work required for commissioning, maintenance and repair can be conducted by appropriate skilled personnel.

The Service Hotline

There is further information available under Chapter 8 "**Service information**" on page 23 for questions about the UPS unit, about the operating manual, service etc.

Copyright

Any passing on, duplication and/or transfer by means of electronic or mechanical means, also extracts thereof, of this operating manual, requires express prior written permission from **JOVYATLAS**.

Copyright **JOVYATLAS**. All rights reserved.

TABLE OF CONTENTS

Chapter	Contents	Page
1.	GENERAL NOTES	6
2.	DESCRIPTION OF THE SYSTEM	6
3.	GENERAL DESCRIPTION OF THE FUNCTION	7
4.	TECHNICAL DATA	9
5.	DIMENSIONS AND VIEWS OF THE UPS UNIT POWERMASTER S 1002	10
5.1	DIMENSIONS AS A 19" VERSION	10
5.2	DIMENSIONS AS A FLOOR-MOUNTED APPLIANCE	11
5.3	DIMENSIONS AS A WALL-MOUNTED APPLIANCE	12
5.4	FRONT AND REAR VIEW OF THE POWERMASTER S 1002	13
5.5	FRONT AND REAR VIEW OF THE POWERPACK S 1002	15
5.6	INSTALLATIONSOPTIONS FOR POWERMASTER S 1002	16
5.6.1	POWERMASTER S 1002 FOR VERTICALE - OR FOR WALL MOUNTING:	16
5.6.2	POWERMASTER S 1002 MOUNTED IN 19" CABINET:	17
5.6.3	POWERMASTER S 1002 AS TABLE DEVICE:	18
6.	ELECTRICAL CONNECTION	19
6.1	ELECTRICAL CONNECTION OF THE UPS UNIT POWERMASTER S 1002	19
6.2	COMMISSIONING THE UPS UNIT POWERMASTER S 1002	20
6.3	SHUTTING-DOWN THE UPS UNIT POWERMASTER S 1002	20
7.	OPERATING AND INDICATING ELEMENTS	21
7.1	FUNCTION OF LED´S AND FUNCTION KEYS	21
7.2	PARAMETERS OF THE UPS UNIT POWERMASTER S 1002	22
7.3	CONFIGURATION OF THE UPS UNIT POWERMASTER S 1002	23
7.4	TABLE OF THE ADJUSTABLE PARAMETERS	23

7.5	MANUAL TESTING OF THE POWERMASTER S 1002	24
7.6	OFFLINE MODE	24
7.7	FREE RUNNING MODE	24
7.7.1	FREE RUNNING ON	24
7.7.2	FREE RUNNING OFF	24
7.7.3	SETTING THE BYPASS TOLERANCE + ACTIVATION/DEACTIVATION OF THE BYPASS	24
7.7.4	FREE RUNNING ON, BYPASS DEACTIVATED	25
7.7.5	FREE RUNNING ON, BYPASS ACTIVATED	25
7.7.6	GENERATOR MODE	25
7.8	ERROR MESSAGES AND THEIR REMOVAL	26
7.8.1	OPTICAL AND ACOUSTICAL ERROR MESSAGES	26
8.	SERVICE INFORMATION	27
9.	REMOTE MONITORING	27
9.1	CONNECTING THE UPS TO THE COMPUTER	27
9.2	ASSIGNMENT OF THE RS232 INTERFACE	27
9.3	USB PORT (OPTIONAL)	28
10.	SPECIAL EQUIPMENT	28
10.1	ELECTRONIC STOP FUNCTION	28
11.	MANUAL BYPASS FOR THE POWERMASTER S 1002 (OPTIONAL)	28
12.	VOLT-FREE MESSAGES VIA THE RELAY CARD (OPTIONAL)	29
12.1	DESCRIPTION OF THE RELAY CARD	29
13.	POWERPACK S 1002	31
13.1	EXTENDED BACKUP TIMES	31
13.2	BATTERY OPERATION	31
13.3	SERVICE LIFE OF BATTERIES	32

13.4	INSTRUCTIONS FOR USING THE BATTERIES	32
14.	REPLACING AN INTERNAL UPS BATTERY	33
15.	NOTES	34
Index 0	10.10.2014	Original
Index 1	06.11.2014	14/608

1. General notes

NOTE!

The UPS should be attached to the mains supply and switched on at the latest 4 weeks after receipt in order to prevent the battery discharging itself.

PLEASE NOTE!

The batteries used are just designed for the required bridging time to meet the nominal load of the UPS. Operation of the UPS unit in free running mode for a longer period of time on battery can damage the batteries. This effect is due to the nature of the battery since for a longer discharge period the final discharging voltage is not reached.

The device may only be opened by trained specialists.

The system is to be connected up and earthed according to VDE regulations. Provisions of the local energy – supply company must be observed.

The ventilation slits on the front and rear sides must not be covered and a distance from the wall of at least **100 mm** is essential.

The UPS unit is built according to Protection Class **IP 21** and is designed for installation in heated internal spaces (at 20°C). A lower operating temperature lowers the bridging time.

No devices with a connecting cable in excess of **10 metres** in length should be connected to the UPS. This measure serves to ensure observance of the EMC standard.

No alterations should be made to the UPS unit. The warranty will expire in cases of inappropriate physical interventions.

PLEASE NOTE!

In order to exclude the possibility of overloading or constant switching over to bypass due to consumer generated non-sinusoidal current peaks, no devices such as laser printers, fax machines as well as devices operating with a similar technology should be connected to the UPS.

In cases where it is essential that such devices be operated then a UPS must be selected whose capacity can match the maximum possible current peaks.

Devices with power reduction due to half wave power consumption, (e.g. coffee machines, hair dryers) can lead to immediate destruction of the power-output stage. The battery is not galvanically isolated from the mains so occurrence of a mains voltage at the battery terminals is possible! The UPS unit does not have an output transformer and is therefore not galvanically isolated from the mains!!

2. Description of the System

Power supply devices of the model range **POWERMASTER S** are particularly suited for supplying important power consumers in industry and the office such as personal computer, computer-controlled devices, PLCs and similar equipment. The output voltage is sinusoidal. In normal cases the attached consumers are supplied with power from the installed rectifier and installed inverter from the mains power supply network (online operation). Any disturbances in the mains such as voltage peaks, voltage drops, harmonic distortions or noises etc. are filtered out. The installed battery is constantly being charged up by means of a charging rectifier with a charge preservation charging stage which is gentle on the batteries.

3. General description of the function

Normal operation

During normal operation the battery and the inverter are supplied with power via a rectifier (online operation). The change-over from alternating voltage to direct voltage and back to alternating voltage again is achieved by a sinusoid output voltage with a low distortion factor. The direct voltage is also needed for charging the battery. The inverter supplies the attached consumers.

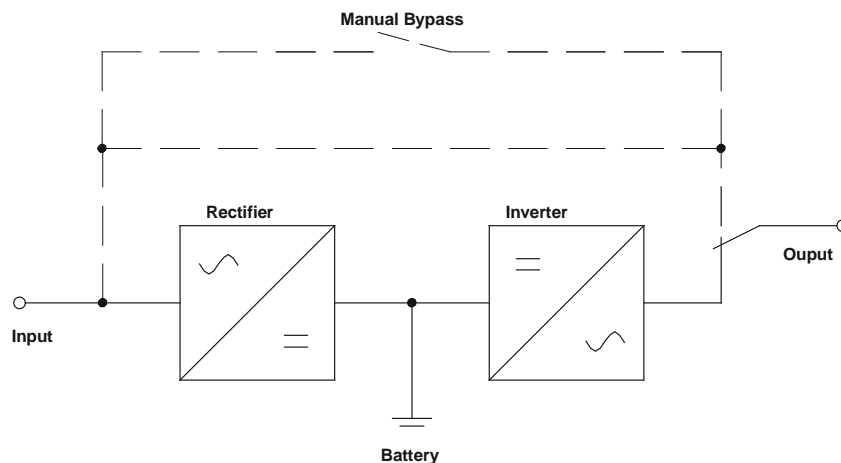

Figure 1: Block diagram "Normal operation"

Power failure

In the case of a power failure, the energy needed by the inverter is taken from the battery. At the output the voltage from the inverter is still available.

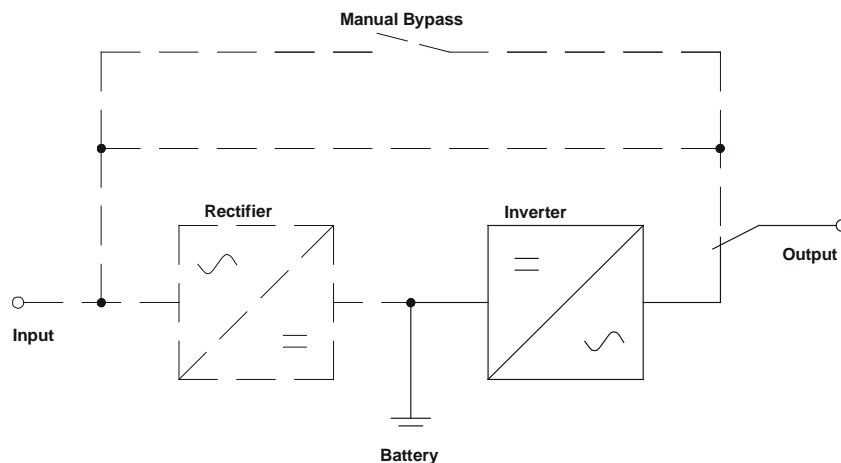

Figure 2: Block diagram "Power failure"

PLEASE NOTE!

The output of the UPS unit also carries a voltage in the case of a power failure!
This is why the installation engineer must mark the outputs and power sockets on the UPS unit clearly according to EN 62040.

Fault in the inverter or an overload (bypass operation)

In the case of a fault occurring in the inverter or an overload, a switch-over device switches the load back to the mains. This means that, in the case of a power failure, the connected consumers will no longer be supplied with power.

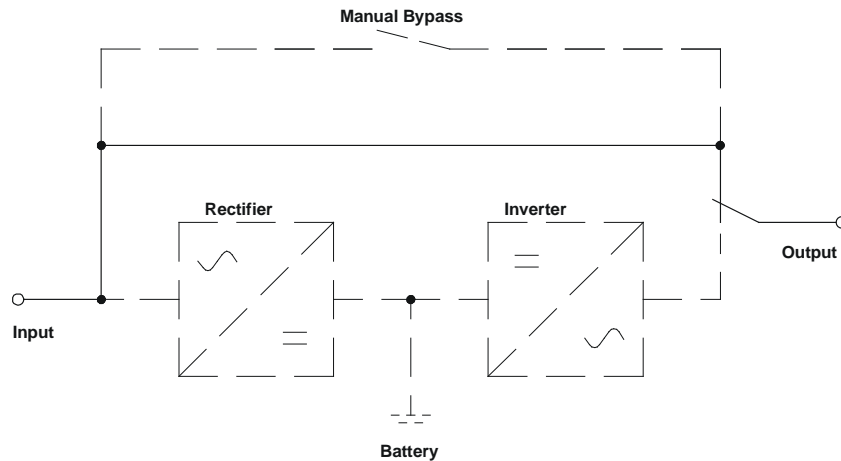

Figure 3: Block diagram "Fault in the inverter"

Manual bypass (service bypass)

If there is a fault in the UPS unit and service work must be undertaken, the UPS unit is fitted with an internal bypass for that purpose. When actuating the manual bypass, the load is directly supplied from the mains. This means that, in the case of a power failure, the connected consumers will no longer be supplied with power. When using the manual bypass it is essential to observe the chapter "UPS internal manual bypass". Other procedures could lead to destruction of the UPS unit or crashing of the power consumer loads.

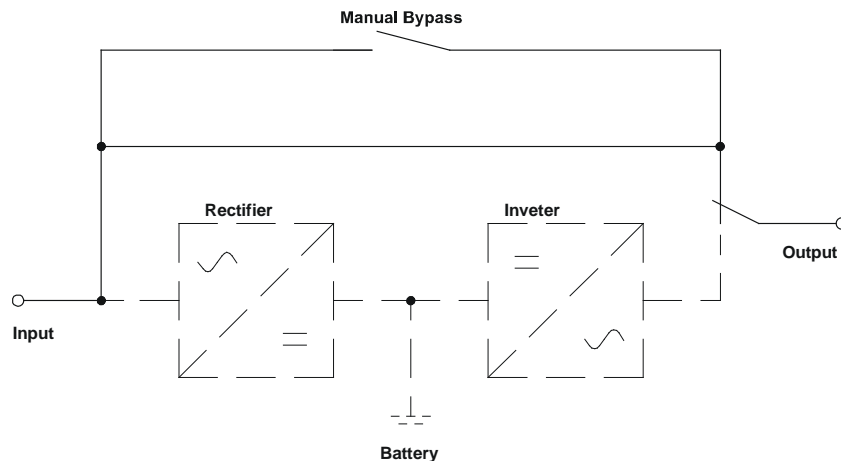

Figure 4: Block diagram "Manual bypass"

PLEASE NOTE!

An operating fault can lead to total loss of power supply to the attached power consumer loads! A power failure for a switched in manual bypass will lead to crashing of the power consumer loads!

4. Technical data

POWERMASTER S 1002		
Output	cos φ 0,7 ind.	1000VA / 700W
Network supply	Voltage	230V Input voltage ranges 168V - 276V (0-100% load) 140 - 159V (0-70% load) 120 - 139V (0-40% load)
	Current	3,6A
	Frequency	50Hz \pm 3Hz or 60Hz \pm 3Hz
	Phase	Single phase
	Power factor	0.98
	External fuse protection	D01/10A
Battery (installed in the battery rack POWERPACK S 1002)	Direct current link voltage	36 V
	Backup time 50% load	10 min at 100% Load 12 min at 80% Load 18 min at 50% Load
	Model	Maintenance-free, closed lead acid batteries
	Charging time	< 8 hours for a 90% discharge
Output	Voltage	230V standard (208V / 220V / 240V selectable at the panel)
	Frequency	Automatic adjustment via the die UPS unit
	Power factor	cos φ 0,7 ind.
	Phase	Single phase
	Distortion factor	< 3% for a linear load
	Overload behaviour	100 to 125% for 60 seconds 125 – 150% for 10 seconds
	Crest Factor	3 : 1
Efficiency	AC to AC	88 - 98% according to the operating mode
Switch-over behaviour	Power failure	0 ms
	Overload switching	Automatic overload switching by the UPS unit
Noise level	At an approx distance of 1 metre	< 40dB(A)
Environment	Temperature	0°C to 40°C +15 ... +25°C (recommended)
	Air humidity	0% to 95%, non-condensing
Storage at ...		20°C (recommended) with battery -20°C to + 50°C without battery
Interfaces	RS 232 interface	Supports power management and diagnosis such as BATTERY LOW, UPS ON/OFF Software is compatible with operating systems such as: Windows 95/98/NT/2000/XP, Novell, Unix, etc current operating systems .
	Optional: USB interface	
	Relay card	
	AS/400 - adapter	
	SNMP - adapter	
Dimensions UPS rack POWERMASTER S 1002	Width	19"
	Depth	425 mm
	Height	2RU
Dimensions battery rack POWERPACK S 1002	Width	19"
	Depth	425 mm
	Height	2RU
Weight of UPS	POWERMASTER S 1002	approx. 9,7 kg
Weight of UPS incl. battery	POWERMASTER S 1002	about 17.3 kg incl. batteries
Scope of delivery	Hardware/software	UPS unit POWERMASTER S 1002 Battery rack POWERPACK S 1002 (according to backup time: 0-2) Manual BAX 3006E Interface cable Software UPSMON

5. Dimensions and views of the UPS unit POWERMASTER S 1002

5.1 Dimensions as a 19" version

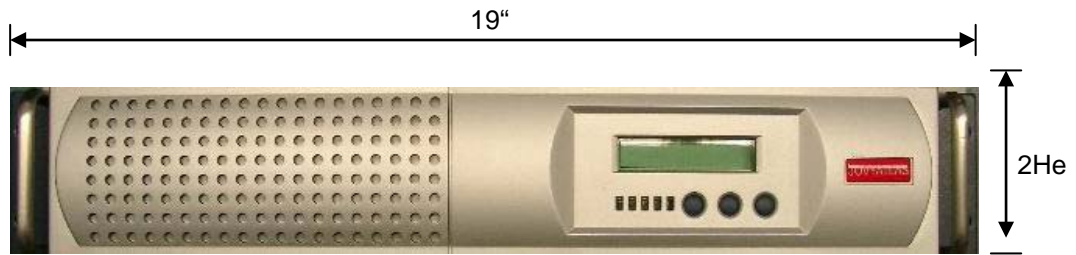

Picture 1: Front view of the POWERMASTER S 1002

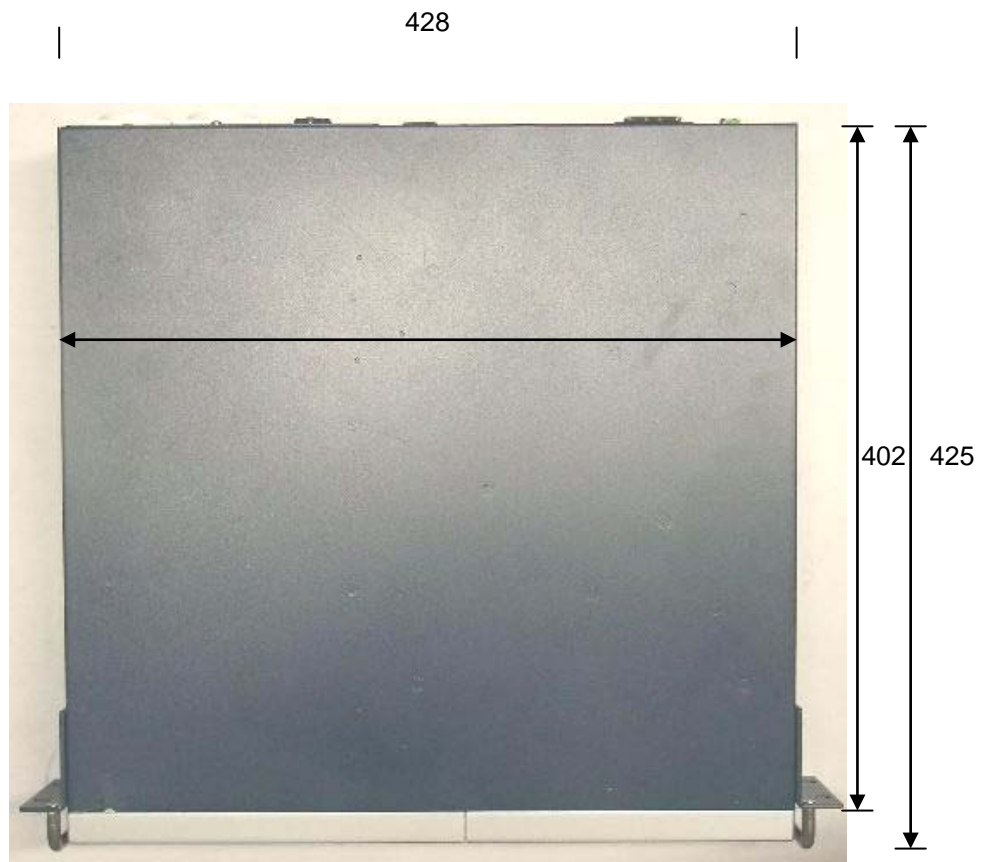

Picture 2: Top view of the POWERMASTER S 1002

5.2 Dimensions as a floor-mounted appliance



Picture 3: Front view of the POWERMASTER S 1002



Picture 4: Top view of the mounting bracket for the POWERMASTER S 1002

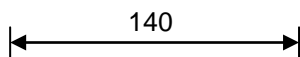

5.3 Dimensions as a wall-mounted appliance

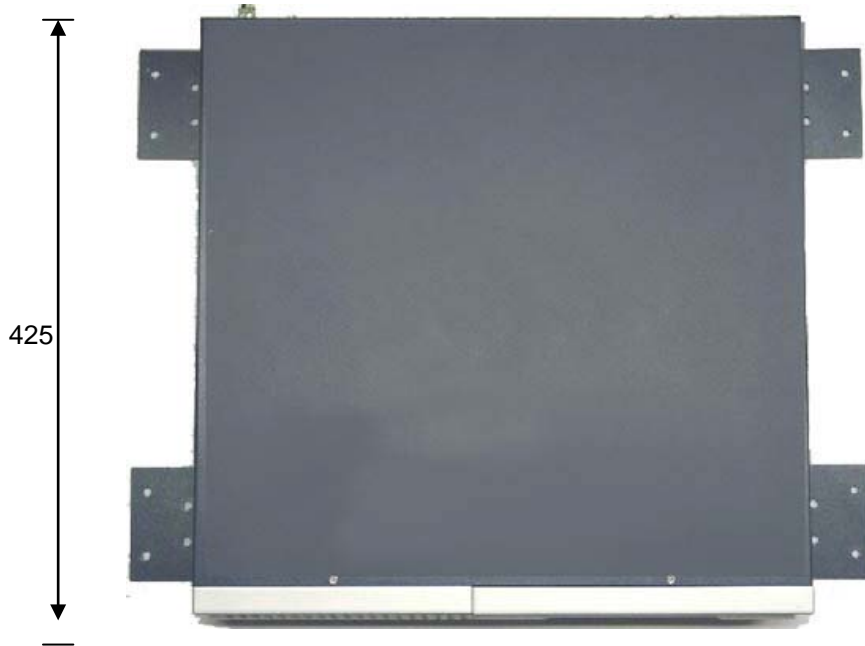

Picture 5: Top view of the POWERMASTER S 1002

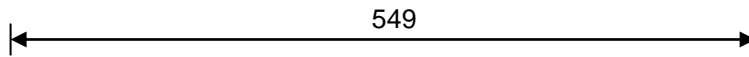

Picture 6: Top view of the Battery Pack POWERMASTER S 1002

5.4 Front and rear view of the **POWERMASTER S 1002**

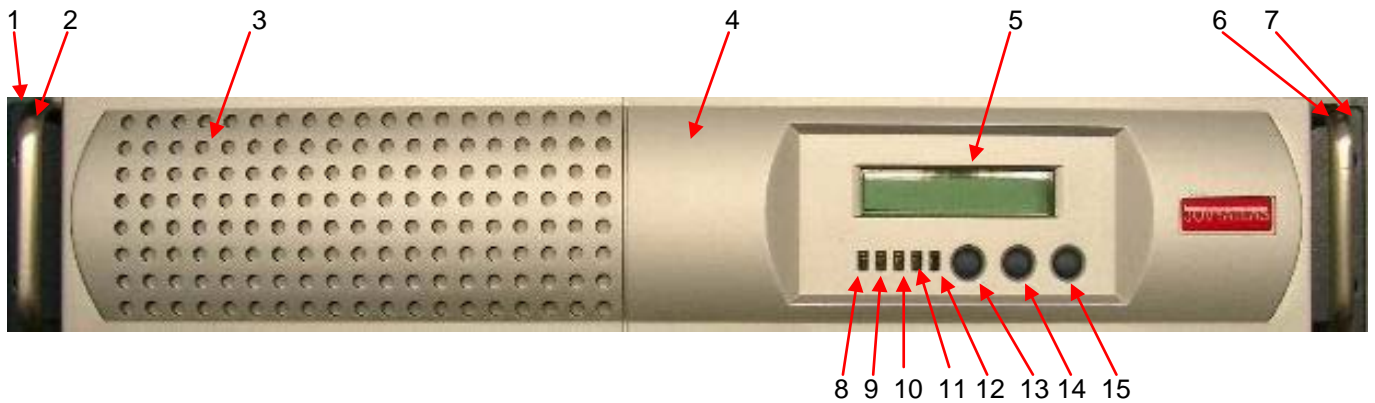

Picture 7: Front view of the **POWERMASTER S 1002**

Position	Designation
1.	Mounting bracket on the left
2.	Retaining bracket on the left
3.	Ventilation inlet
4.	Removable display cover (battery change)
5.	Display indicator
6.	Fastening bracket on the right
7.	Retaining bracket on the right
8.	LED operation, glows green if the UPS is switched on
9.	LED operation, glows green when in UPS and bypass mode and signals that the output voltage is present.
10.	LED battery operation, glows yellow if there is a power failure
11.	LED bypass operation, glows yellow if the UPS is running in bypass mode
12.	LED – UPS fault, glows red if there is an internal fault in the UPS unit
13.	FUNC key for selecting the parameters (see Chapter 7.1)
14.	ENTER key for querying set parameters (see Chapter 7.1)
15.	ON/OFF button for switching the UPS unit on and off (see Chapter 7.1)

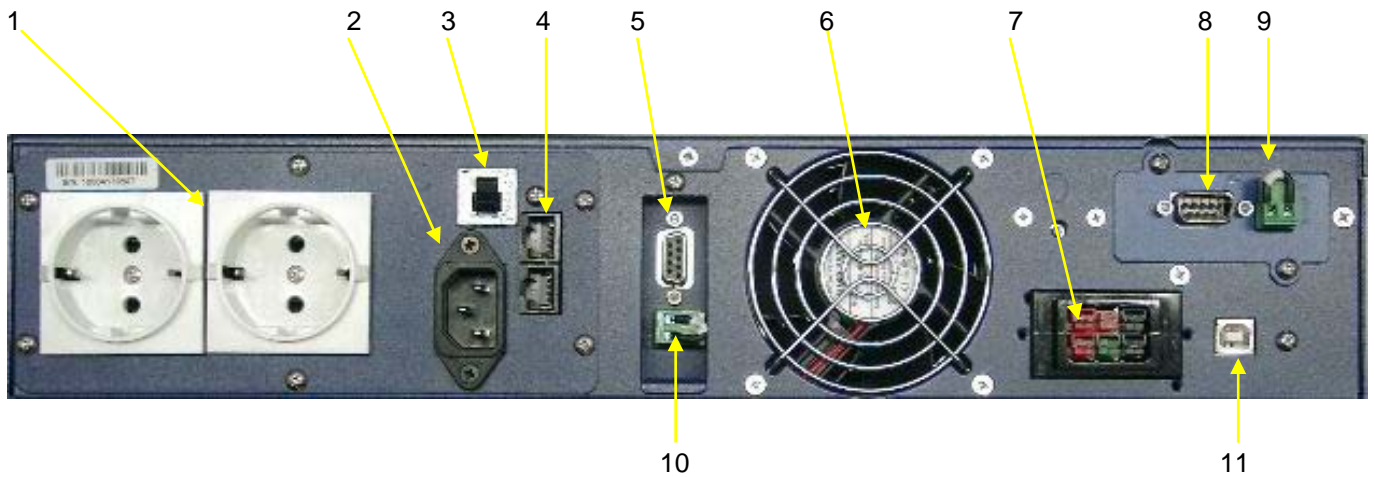

Picture 8: Rear view of the POWERMASTER S 1002

Position	Designation
1.	UPS output sockets will be exchanged against cold output sockets
2.	UPS mains input socket (input connector for non-heating apparatus)
3.	Input fuse 10A
4.	TAE protective circuit
5.	RS 232 interface
6.	Fan
7.	Battery jack (external battery pack)
8.	Relay card (SUB – D)
9.	Electronic Stop (for connection of a voltage-free breaker)
10.	Electronic Stop (for connection of a voltage-free breaker)
11.	USB interface (Optional)

5.5 Front and rear view of the POWERPACH S 1002



Picture 9: Front view of the POWERPACH S 1002

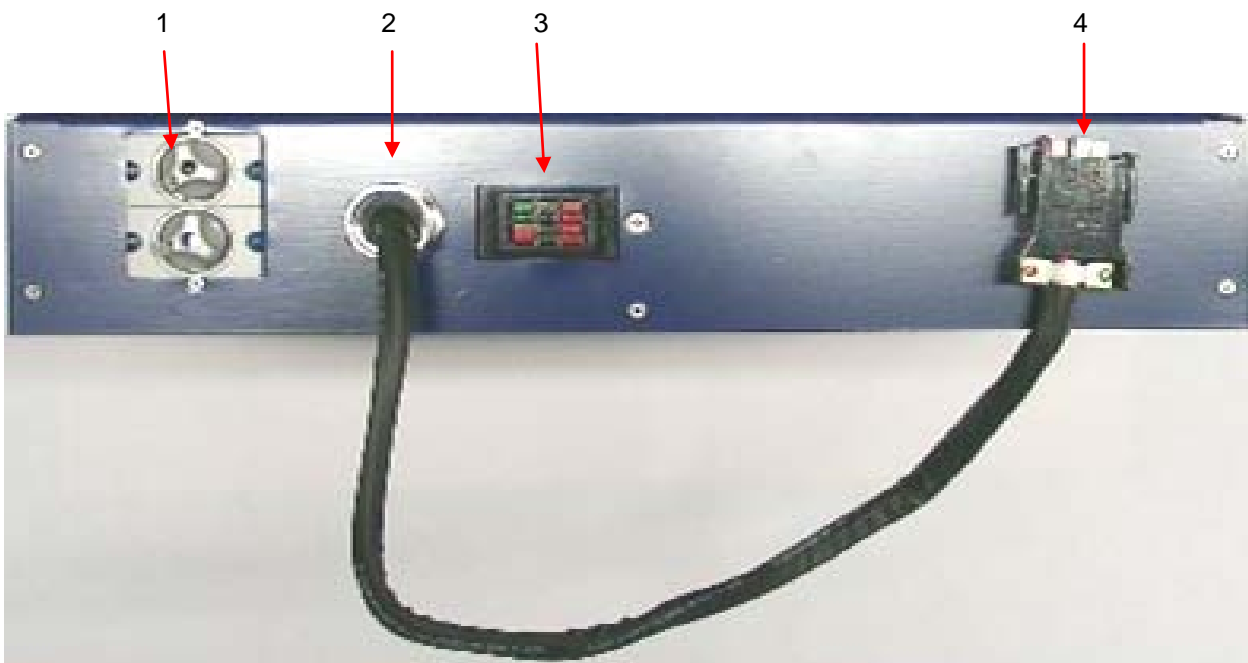

Picture 10: Rear view of the POWERPACH S 1002

Position	Designation
1.	Battery fuses
2.	Cable gland for the battery cable
3.	Connecting jack for an optional additional battery pack
4.	Battery plug for connecting to the UPS unit

5.6 Installationsoptions for Powermaster S 1002

5.6.1 Powermaster S 1002 for verticale - or for wall mounting:

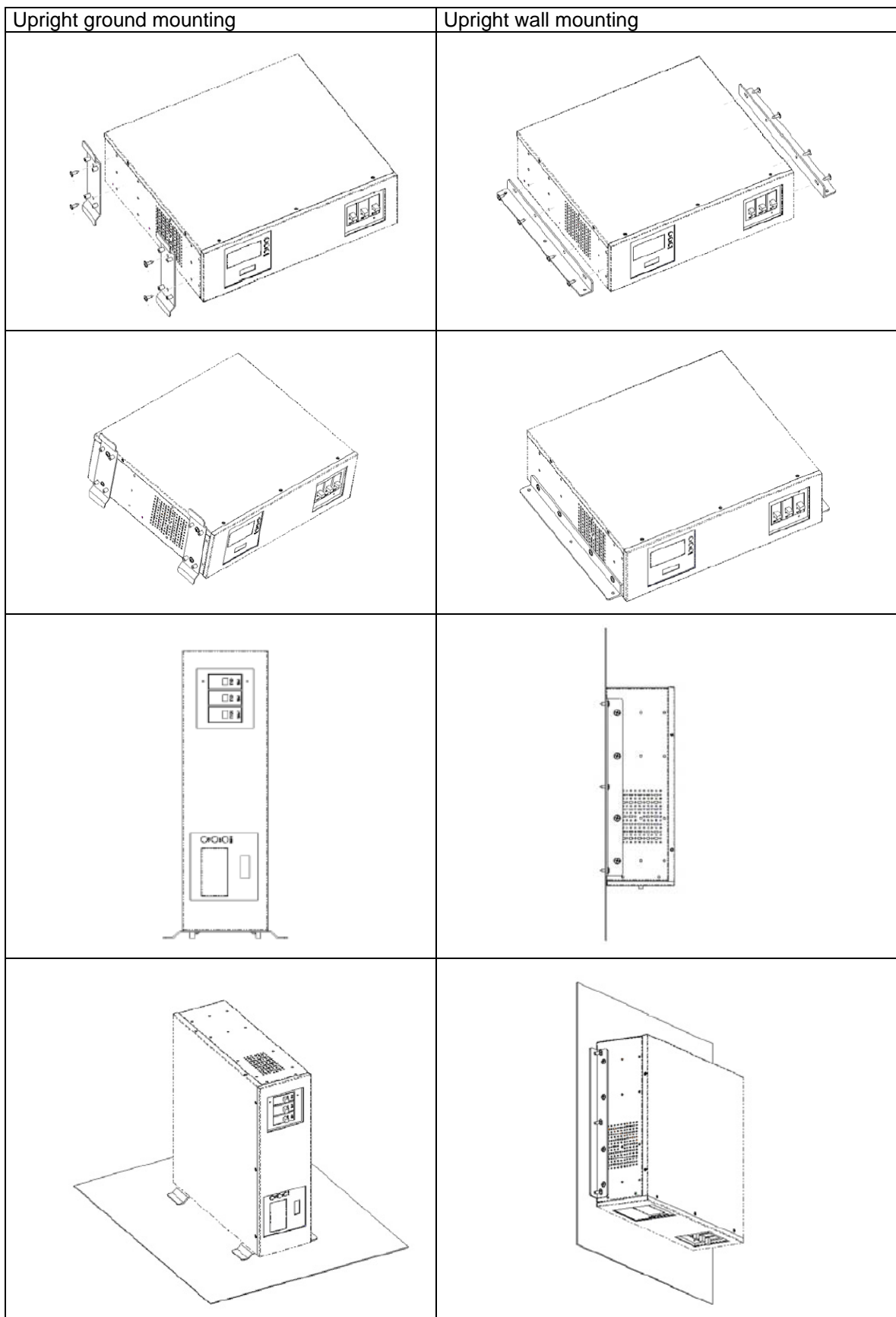

5.6.2 Powermaster S 1002 mounted in 19" Cabinet:

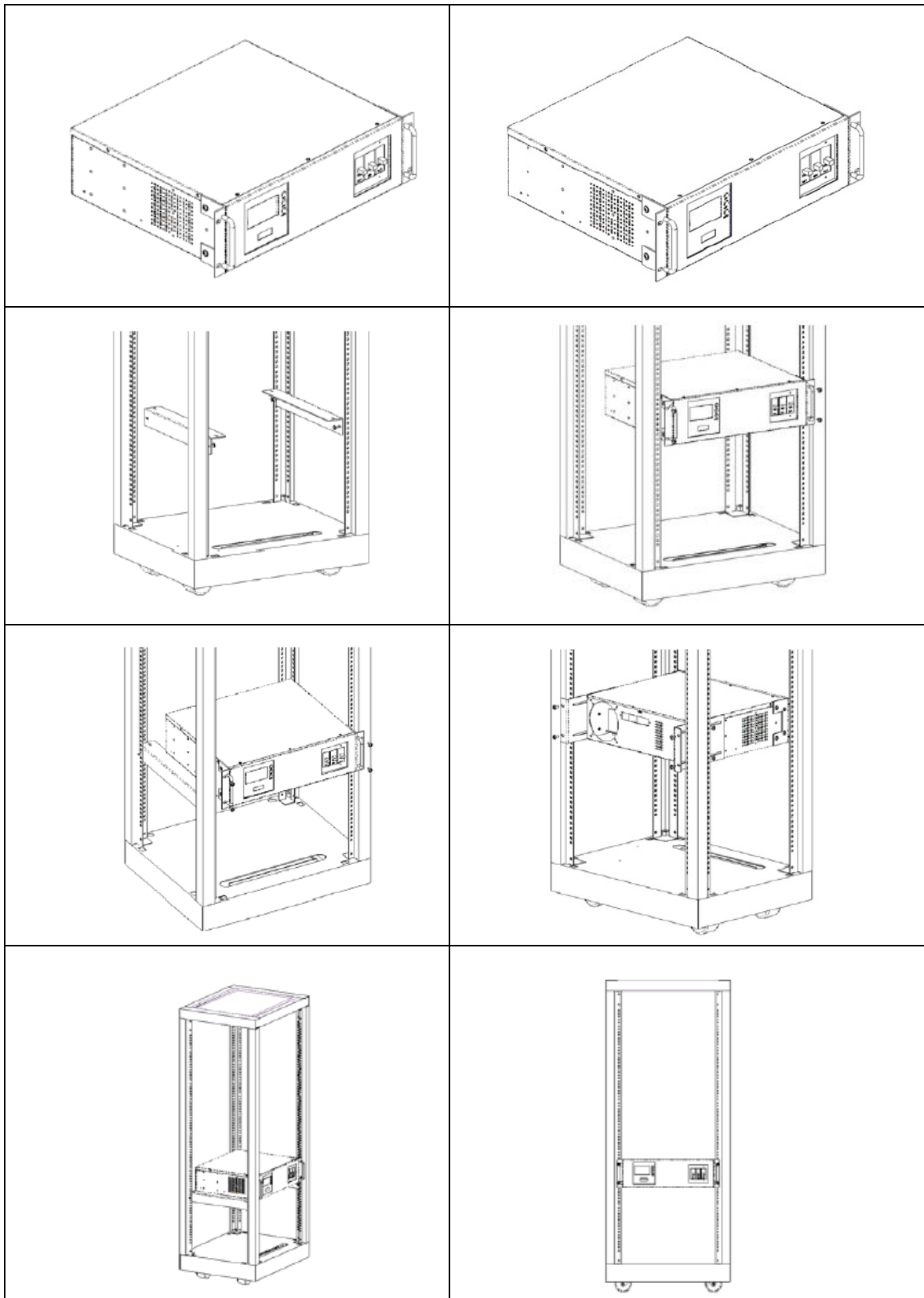

5.6.3 Powermaster S 1002 as Table Device:

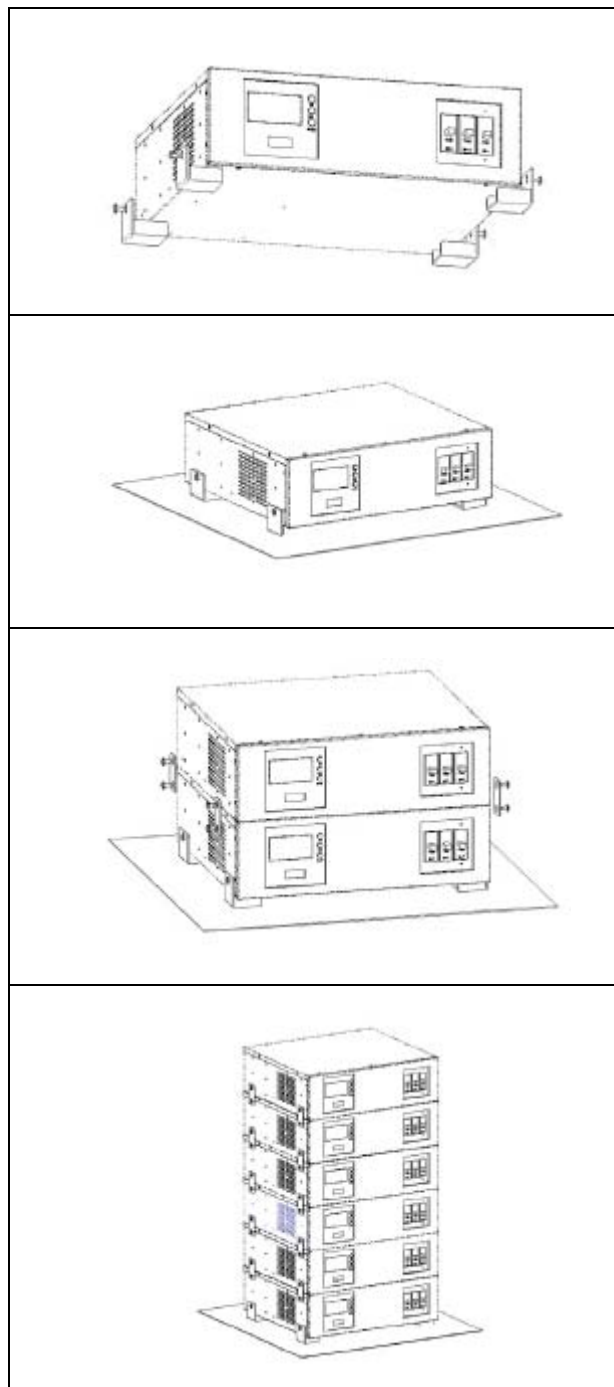

6. Electrical connection

PLEASE NOTE!

Only trained personnel are allowed to work on the UPS unit.

Observe all corresponding safety regulations.

Marking of cables is to be according to DIN EN 60445!

When connecting to the UPS unit, ensure use of an adequately sized protective-conductor connection!

PLEASE NOTE!

When working on the batteries it is possible for dangerous situations to arise due to a high DC voltage and high short-circuit currents.

This work on the device must only be conducted when accompanied by use of suitable protective measures such as insulated tools, eye and hand protection

6.1 Electrical connection of the UPS unit **POWERMASTER S 1002**

The UPS unit in the series **POWERMASTER S 1002** is simply connected via the installed mains connection socket (input connector for non-heating apparatus) and the 1.5 metre long mains connection cable (cable for non-heating apparatus) to the power socket for non-heating apparatus provided.

One proceeds as follows:

1. Plug the mains input cable (cable for non-heating apparatus) provided into the foreseen power socket for non-heating apparatus.
2. Attach the power consumers via the protective contact socket.
3. Connect up the battery pack supplied (**optional for longer autonomy times**) via the battery connection jack.
4. All connecting up work is now complete.

6.2 Commissioning the UPS unit **POWERMASTER S 1002**

P L E A S E N O T E !

The unit should be started over the input mains. If the input mains is not available for a short time then it is also possible to start the unit over the external battery. It is a basic prerequisite for this operating mode that the UPS unit was one time operated over the energy supplier's mains network. Please note that when starting over the external battery, the maximum time the output voltage is available to you is the autonomy time. The UPS unit will also start with the planned parameter, that is if the mains previously had 50 Hz then the UPS will also produce 50 Hz on the output side.

P L E A S E N O T E !

The voltage specification on the UPS must coincide with the voltage specification on the battery cabinet (DIRECT CURRENT LINK VOLTAGE) otherwise there is danger of destroying internal components of the UPS or destruction of the battery.

Take note: The unit fans run as soon as the input voltage is applied!!

The UPS unit can now be started by pressing the **ON/OFF** button in the front panel for 2 seconds; a message appears in the display: **Switching on procedure**. The UPS unit now starts a self-test routine during which its internal functions are tested and the mains synchronisation and the inverter are started. The message "**Battery mode**" is shown in the display during the self-test and the LED's **ON** for UPS ON and **ON-LINE** output voltage light up. The message "**Operation**" appears in the display. The consumers to be supplied can now be switched on.

Please contact us if anything different happens.

6.3 Shutting-down the UPS unit **POWERMASTER S 1002**

When shutting down the unit please proceed as follows:

- Switch off all consumers
- Press the **ON/OFF** button in the front panel for 5 seconds. An acoustic sound (bleep) is emitted while pressing the **ON/OFF** button and the message: **Switching off soon** appears in the display, and then the message "**UPS OFF**". The UPS unit is now shut-down. **Please note:** The device fans continue to run as long as the input voltage is applied.

7. Operating and indicating elements

7.1 Function of LED's and function keys

1. Display indicator

The display indicator informs about the operating modes, menu points and parameters.

2. ON/OFF button

The UPS unit can be switched on and off using the **ON/OFF** button. The formalism is as follows:

The UPS unit is switched on by pressing the **ON/OFF** button for about 3 seconds.

The UPS unit is switched off by pressing the **ON/OFF** button for about 3 seconds.

3. ENTER key

The **ENTER** key can be used to query the parameters which have been set for the UPS unit. Pressing the **ENTER** key for 2 seconds on a running UPS unit will automatically cause the first parameter to be displayed for 10 seconds. Pressing the **ENTER** button again allows one to manoeuvre through the parameters. If the next parameter is not selected within 10 seconds then the UPS unit indicates its condition again.

4. FUNC key

The **FUNC** key can be used to set a parameter such as the output voltage etc.

The formalism is as follows:

Press the **FUNC** key on a running UPS unit for 2 seconds to start the menu for the UPS unit parameters. Pressing of the **ENTER** button selects the parameter to be altered. Once the parameter to be altered is reached then the desired value can be selected by pressing the **FUNC** button. Pressing the **ENTER** button a second time accepts the desired parameter and stores it.

The function and condition in which the UPS unit currently finds itself is displayed over 5 LED's in the function panel.

The conditions are as follows:

5. ON	Operation	: This LED glows green if the UPS is switched on
6. ON-LINE	Operation	: This LED glows green both in UPS mode and in bypass mode and also signals that there is an voltage at the output.
7. ON-BAT	Battery operation	: This LED glows yellow for battery operation (power failure)
8. BYPASS	BYPASS	: This LED glows yellow if the UPS unit is running in bypass mode
9. FAULT	FAULT	: This LED glows red if there is an internal error in the UPS, and an acoustic signal is emitted. Press any key in the function panel and the alarm will be switched off. The cause of the alarm is shown in the display.

7.2 Parameters of the UPS unit **POWERMASTER S 1002**

Indicator	Function of the indicator
O/P VOLT = 230.0V	Output voltage of the UPS
O/P FREQ = 50,0Hz	Output frequency of the UPS
I/P VOLT = 230,2V	Input voltage of the UPS
I/P FREQ = 50,2Hz	Input frequency of the UPS
BAT VOLT = 24V	Battery voltage of the battery pack
O/P LOAD% = 80%	Utilisation of the UPS as a percentage
O/P W = 1050W	Output in Watts
O/P VA = 1500VA	Output in VA
O/P CURR = 2A	Output current in A
BACKUP TIME = 6Min.	Autonomy time for the current loading
BAT CHARG = 80%	Battery charge level in percent
TEMPERATURE = 28°C	Temperature of the UPS
BAT PACK NUM = 4	Number of battery packs used
RATING = 1500VA	Nominal value of the UPS in VA
CPU VERSION 3.12	CPU software

7.3 Configuration of the UPS unit **POWERMASTER S 1002**

Use of the function display and the function keys allows diverse settings to be made on the UPS unit. The formalism is as follows:

- In order to achieve Configuration Mode it is necessary to press the key **FUNC** for 2 seconds. The first configuration parameter appears in the display.
- The key **FUNC** is used to manoeuvre through the parameters.
- The key **ENTER** is used to select the parameter point to be altered.
- The key **FUNC** is used to move through the options for the selected parameter.
- The key **ENTER** is used to confirm the selected option and the display readout: Save ? appears before hand
- Saving is achieved by pressing the key **ENTER** again.

PLEASE NOTE!

If the selected option is not stored within 10 seconds then the value is reset automatically and the menu goes back into its normal condition.

7.4 Table of the adjustable parameters

Adjustable parameter	Indication in the display	Explanation	Selections for parameter	Factory setting
Adjusting the output voltage	O/P V adjustment	Nominal voltage	208/220/ 230/240V	230V
Setting the input frequency tolerance	I/P Freq. Adjustment	Frequency tolerance in unsynchronised mode	± 2% ± 5% ± 7%	± 5%
Setting of the tolerance of the bypass voltage	I/P bypass adjustment	Voltage tolerance	± 10% +10/-15% +15/-20%	+10/-15%
Free Run Mode	Free-Run-Set	Unsynchronised mode	ON/OFF	ON
Bypass activation/deactivation in Free Run Mode	Free-Run-Mode	If activated the UPS will switch to bypass if the preset parameters are not maintained	ON/OFF	OFF
Operating mode setting	HE mode setting	Online/Offline mode	ON/OFF	OFF
Setting for a permanent manual bypass	Man. bypass setting	Activate manual bypass (only for servicing)*	ON/OFF	OFF
Load management	Load segment setting	Segment 1 ON/OFF Segment 2 ON/OFF	ON/OFF	ON
Performing a battery test	Manual battery test	Battery test Battery OK. Battery not OK.	ON/OFF	OFF
Quiet functioning	Alarm acoustic	Activate, deactivate the acoustic alarm	ON/OFF	OFF
Number of battery packs	No. of ext. batteries	Setting number of battery packs for the autonomy calculation; a maximum of 2	1 - 2	Dependent on the required bridging time
Reversal polarity protection	Phase reversal setting	Activation, deactivation of phase reversal	ON/OFF	OFF
Language selection	Language	Language selection	English German French Spanish Italian	German
Generator mode	Generator	Generator mode**	ON/OFF	OFF
Setting RS 232 interface	COM control command	Setting of RS232 interface	ON/OFF	ON

*) The manual bypass function should always be switched off since for a switched on manual bypass the load in the case of a power failure cannot be supplied by the UPS.

***) The UPS should be switched off and then switched on again before the generator is switched.

7.5 Manual testing of the POWERMASTER S 1002

The UPS unit is capable of conducting a self-test. Pressing the key **FUNC** causes the unit to run with its configurations menu. Manoeuvre to the point: **Manual Battery Test**. Now press the button **ENTER**. The message **TEST?** appears in the display. If you wish to perform a battery test then confirm by pressing the key **ENTER**. The battery test will now be performed by the UPS unit by itself. The UPS unit will then again run by itself in its normal operating mode after the battery test has been performed successfully. **It is not necessary to operate any switches to do this!!**

If the battery is faulty, the message **E07** will be shown in the display and a permanent tone will sound. Please replace the battery.

7.6 OFFLINE mode

The UPS unit can be operated using special settings via the display or with the software supplied in offline mode. This operating mode has the advantage of only using a small amount of energy.

The formalism for setting to OFFLINE mode is as follows:

- The key **FUNC** must be pressed for 2 seconds to obtain configuration mode.
The first configuration parameter appears in the display.
- The key **FUNC** can be used to manoeuvre through the parameters.
- Select the parameter point to be altered using the key **ENTER**, in this case: HE mode
- The key **FUNC** is then used to manoeuvre through the options for the selected parameter (ON/OFF).
- You have the option to select between 10% and 15%, which are the thresholds to be monitored, and if the voltage does not meet this criterion then the UPS switches to battery operation.
- The selected option is confirmed using the key **ENTER** and saved by pressing the key again.
- Ensure that the settings were adopted in that the display shows: High Efficiency.
- The UPS unit will start again automatically after restoration of the mains power and starts in the preset mode after a long period of power loss where the end of the autonomy period was reached and the UPS shut down once the final discharge voltage was reached.

7.7 Free running mode

The text below explains the free running mode. The preset input frequency window of the UPS has a range of 45Hz - 65Hz and is referred to in the following as the input frequency range.

The narrow input frequency range has a frequency range of 49Hz - 51Hz. This range can be set via the display and operates in the following ranges:

I/P input frequency low = $50 \times (1-0.02) = 49\text{Hz}$

I/P input frequency high = $50 \times (1+0.02) = 51\text{Hz}$

7.7.1 Free running ON

If the input frequency is 49.3Hz, this value is within the narrow input frequency range. This means that the output frequency is also 49.3Hz (synchronised) and the UPS unit runs in line mode. If the input frequency then drops below 49Hz, for example 48Hz, the input frequency is outside the narrow input frequency range but still within the broader input frequency window. The output frequency will therefore be 50Hz and the UPS unit will remain in line mode. If the input frequency were 43Hz then it would be outside both the narrow and the broader input frequency window. The UPS unit switches to battery operation and supplies the load via the inverter with 50Hz.

7.7.2 Free running OFF

If the input frequency is 49.3Hz, this value is within the narrow input frequency range. This means that the output frequency is also 49.3Hz (synchronised) and the UPS unit remains in line mode. If the input frequency then drops below 49Hz, for example 48Hz, then the input frequency is outside the specified values for the narrow input frequency range and the UPS unit switches to battery operation and supplies the load via the inverter with 50Hz.

7.7.3 Setting the bypass tolerance + activation/deactivation of the bypass

The UPS unit offers the option of activating and deactivating the bypass. There is also the option of setting the bypass network tolerance via the display (see Chapter 7.4).

The functionality of the bypass tolerance is described below.

If the UPS unit has a fault and the bypass is activated but the input voltage does not have the quality to supply the consumers then the following examples can arise:

7.7.4 Free running ON, bypass deactivated

Example: Input voltage for bypass: **210 V** Input frequency for bypass: **52Hz** Output voltage of UPS: **230 V**

The bypass tolerance is set to +15/-20% as the bypass range window (set via the display) so the bypass window has the following values:

Bypass lower limit: $230\text{ V} \times (1-0.2) = 230\text{ V} \times 0.8 = 184\text{ V}$ **Bypass upper limit: $230\text{ V} \times (1+0.15) = 230\text{ V} \times 1.15 = 264.5\text{ V}$**

A +/-2% tolerance was selected for the input frequency so the narrow input frequency window is as follows:

Input frequency lower limit: $50\text{Hz} \times (1-0.02) = 49\text{Hz}$ **Input frequency upper limit: $50\text{Hz} \times (1+0.02) = 51\text{Hz}$**

The broader input frequency range covers the range of 45Hz - 65Hz.

The following situation occurs where the UPS unit has a fault. Before the UPS unit switches to bypass the CPU first checks to see whether the input voltage and the input frequency are within the prescribed window.

- The input voltage (bypass) is:
210V and thus suitable for providing power to the load (184 – 264.5V)
- The input frequency (bypass) is:
52Hz and therefore does not fulfil the criterion for the narrow input frequency window.

Result: The UPS unit will not switch to bypass (not activated) since the preset parameter has not been maintained and the bypass is deactivated.

7.7.5 Free running ON, bypass activated

Example: Input voltage for bypass: **210V** Input frequency for bypass: **52Hz** Output voltage UPS: **230V**

The bypass tolerance is set to +15/-20% as the bypass range window (set via the display) so the bypass window has the following values:

Bypass lower limit: $230\text{ V} \times (1-0.2) = 230\text{ V} \times 0.8 = 184\text{ V}$ **Bypass upper limit: $230\text{ V} \times (1+0.15) = 230\text{ V} \times 1.15 = 264.5\text{ V}$**

A +/-2% tolerance was selected for the input frequency so the narrow input frequency window is as follows:

Input frequency lower limit: $50\text{Hz} \times (1-0.02) = 49\text{Hz}$ **Input frequency upper limit: $50\text{Hz} \times (1+0.02) = 51\text{Hz}$**

The broader input frequency range covers the range of 45Hz - 65Hz.

The following situation occurs where the UPS unit has a fault. Before the UPS unit switches to bypass the CPU first checks to see whether the input voltage and the input frequency are within the prescribed window.

- The input voltage (bypass) is:
210V and thus suitable for providing power to the load (184 – 264.5V)
- The input frequency (bypass) is:
52Hz and therefore fulfils the criterion for the broader input frequency window.

Result: The UPS unit switches to bypass since the preset parameter has been maintained and the bypass was activated.

Summary:

Free running mode → On, bypass deactivated → A fault occurs → CPU on UPS checks whether the narrow input frequency window ($\pm 2\%$) and voltage window is being maintained → if parameter OK → no switch-over to bypass → since bypass is deactivated

Free running mode → On, bypass activated → A fault occurs → CPU on UPS checks whether the narrow input frequency window ($\pm 2\%$) and voltage window is being maintained → if parameter OK. → Switch-over to bypass → since bypass is activated.

7.7.6 Generator mode

Generator mode (adjustable via the panel) ensures that the UPS unit is not constantly switching over to battery operation, since the output voltage of the generator often demonstrates distortions or interruptions, but remains in online mode and thus a sinusoidal output voltage for the consumers is achieved.

This functionality has a low loading effect on the battery which means that the working life of the battery is maintained.

PLEASE NOTE!

The UPS unit must be started again after change-over to generator mode.

7.8 Error messages and their removal

This trouble-shooting instruction offers simple tips about how faults can be located and removed. If an error message occurs in the function display then you may well be able to remove the fault yourself using these trouble-shooting instructions.

The UPS emits acoustic error signals for:

- A mains fault; the UPS unit runs in battery mode and the alarm sounds every 5 seconds.
- Battery discharge; unit runs in battery mode and the alarm sounds twice every 5 seconds.
- Internal error in the UPS; the alarm sounds continuously

The acoustic alarm can be silenced by pressing any key.

7.8.1 Optical and acoustical error messages

Error message in the display	Acoustic alarm	Description of the alarm	Removing the fault
Overload (output overload)	Two bleeps per second	The UPS is overloaded. The load needs more power than the UPS can deliver. The UPS is providing power via the bypass.	Reduce the load by switching off unimportant consumers
Battery test (battery test)		UPS performs a battery test	No handling necessary. The UPS switches again to normal operation after a successful battery test
Overcharging (over-charge)	Continuous tone	The batteries are over-charged. (Battery charge voltage too high)	Contact the service hotline!
Battery discharged (low battery)	Two bleeps every 5 sec.	The UPS operates in autonomy mode (loss of input mains) and the final discharge voltage has almost been reached.	The UPS is automatically started again when the input mains network is available again! No handling is required!
Battery operation (on battery)	A bleep every 5 sec.	The UPS operates in autonomy mode (loss of input mains)	Save your data and shut-down your computer in a controlled fashion.
Battery charge fault (charger failure)	Continuous tone	Battery charger defective	Contact the service hotline!
Over-temperature (over-temperature)	Continuous tone	Temperature within the UPS is too high	Ensure that all fans on the UPS are running and are not blocked or dirty
Short circuit on output side (output short)	Continuous tone	Short-circuit on the consumer side	Contact the service hotline!
High output voltage (High output voltage)	Continuous tone	Overvoltage on the consumer side	Contact the service hotline!
Bus fault (Bus fault)	Two bleeps per second	Excessively high voltage on the DC side	Contact the service hotline!
Reverse polarity fault (site wiring fault)	One bleep per second	Voltage detected between N and PE	Deactivate the reverse polarity protection in the menu
Mains fault (line abnormal)	One bleep per second	Synchronisation failed	New start
Battery fault	3 x bleep	No battery or a faulty one	Switch off UPS using the ON/OFF button Connect up a battery.

8. Service information

S E R V I C E – H O T L I N E !

Tel: +49 491 - 6002 - 30 Fax: +49 491 - 6002 - 10

E-mail: service@jovyatlas.de Internet: <http://www.jovyatlas.de>

9. Remote monitoring

The UPS unit is fitted as standard with an RS 232 signal output. This signal output is designed as a RS232-interface (SUB-D, 9-pin), and there is optionally the possibility of using an additional USB interface. Concerning these two interfaces there is the limitation that only one or the other, that is the RS232 or the USB interface, can be used at any one time. There is also the option of using the additional rack at the rear. This rack can be fitted with two different cards, one with an SNMP adapter, which allows monitoring of the UPS via the network or the internet, or an AS/400 card with voltage-free contacts.

The RS 232 and USB interfaces serve to allow data transmission between a computer and the UPS unit.

The UPS unit can be monitored and checked by a computer through the use of special software. Switching off of the UPS unit in the case of power failure is possible.

9.1 Connecting the UPS to the computer

The communication between the UPS and computer is delivered as a complete package including the communication cable and management software. It is absolutely essential to use the communication cable delivered since it was directly configured for the RS 232 interface. Ensure that your operating system is compatible with the management software. Instructions for the management software will aid you in installing the software properly.

9.2 Assignment of the RS232 interface

The RS 232 interface uses a 9-pin SUB-D connector (jack). Assignment of the SUB-D connector is as described in the table below.

Pin assignment for the RS 232 interface

PIN	SIGNAL	DIRECTION	FUNCTION
2	TxD	Output	TxD output
3	RxD	Input	RxD/inverter out Input
5	GND		GND
6	CTS	Output	AC fault on output
8	DCD	Output	Discharge battery
9	RI	Output	+8/-24 VDC

RS 232 interface
(Rear side of UPS)

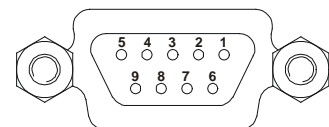

Figure 5: RS232 interface

P L E A S E N O T E !

Maximum value 24VDC/50mA!

9.3 USB port (optional)

Connection of the UPS to a computer is also possible via the USB interface at the rear of the UPS unit. If the USB interface is to be used then simultaneous use of the RS 232 interface is not possible. Communication between the UPS and the computer takes place via a conventional USB connection cable (PC: plug -A / UPS unit: plug -B) and can only be used with the software "UPSMON" delivered as standard and the optionally obtainable JUMP software.

10. Special equipment

PLEASE NOTE!

The following conversion work or extension to the unit may only be performed by trained personnel and with the UPS unit in a deenergised condition.
Observe the relevant safety regulations!!

10.1 Electronic STOP function

The UPS is fitted with an integrated electronic STOP function. This function is deactivated as standard via a bridge at the rear of the UPS unit. If the electronic STOP functionality is to be used then the bridge should be removed on the plug and an external switch (opener) clamped to the rear plug. Actuation of the external electronic STOP switch causes the output of the UPS unit to be switched to voltage-free and the UPS unit shuts down. In order to provide the consumers with a voltage again the electronic STOP switch must be reset and the UPS restarted. There is still a **voltage** inside and at the terminals even after the electronic STOP function was activated.

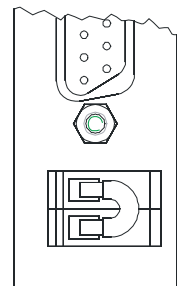

Figure 6: Electronic STOP

11. Manual bypass for the POWERMASTER S 1002 (optional)

For this UPS – Device is an optional additional External Manual Bypass available.
This additional External Manual Bypass will be described in Manual BAX 3945!!!

12. Volt-free messages via the relay card (optional)**12.1 Description of the relay card**

There is also the option to fit the UPS unit with a relay card (**optional**).

This relay card provide voltage-free contacts for external further use. These contacts are designed a standard as closing contacts, that is they close in the case of a fault. There is also a possibility of designing these contacts as opening contacts by reversing a jumper on the relay card. The relay card also makes the electronic – STOP – function available. This function is deactivated as standard over a bridge on the relay card. If the electronic-STOP functionality is used then the bridge should be removed from the plug and an external switch (opener) is to be clamped on the rear plug. Actuation of the external electronic STOP switch causes the output of the UPS unit to be switched voltage-free and the UPS unit shuts down. In order to supply consumers with voltage again it is necessary for the electronic STOP switch to be reset and for the UPS to be restarted. There is still a **voltage** inside and at the terminals even after the electronic STOP function was activated.

The messages which are available on the relay card are as follows:

Pin	Description	I/O type	Contact setting	Normal condition	In the case of a fault
1	UPS fault	Output	1 – 5	opened	closed
2	Group alarm; the following alarms are integrated together: Fault in output voltage Bus fault Overtemperature Overload Overloading Battery test failed Battery charging device – fault	Output	3 – 4	opened	closed
3	GND for output				
4	Remote shutdown (Battery Operation)	Input	3 – 4	opened	closed
5	GND (reference point for the relay actuation)				
6	Bypass active	Output	6 – 5	opened	closed
7	Battery discharged	Output	7 – 5	opened	closed
8	Free				
9	Power failure	Output	9 – 5	opened	closed

When using opening contacts the contact positions must be set appropriately opposed to each other!!

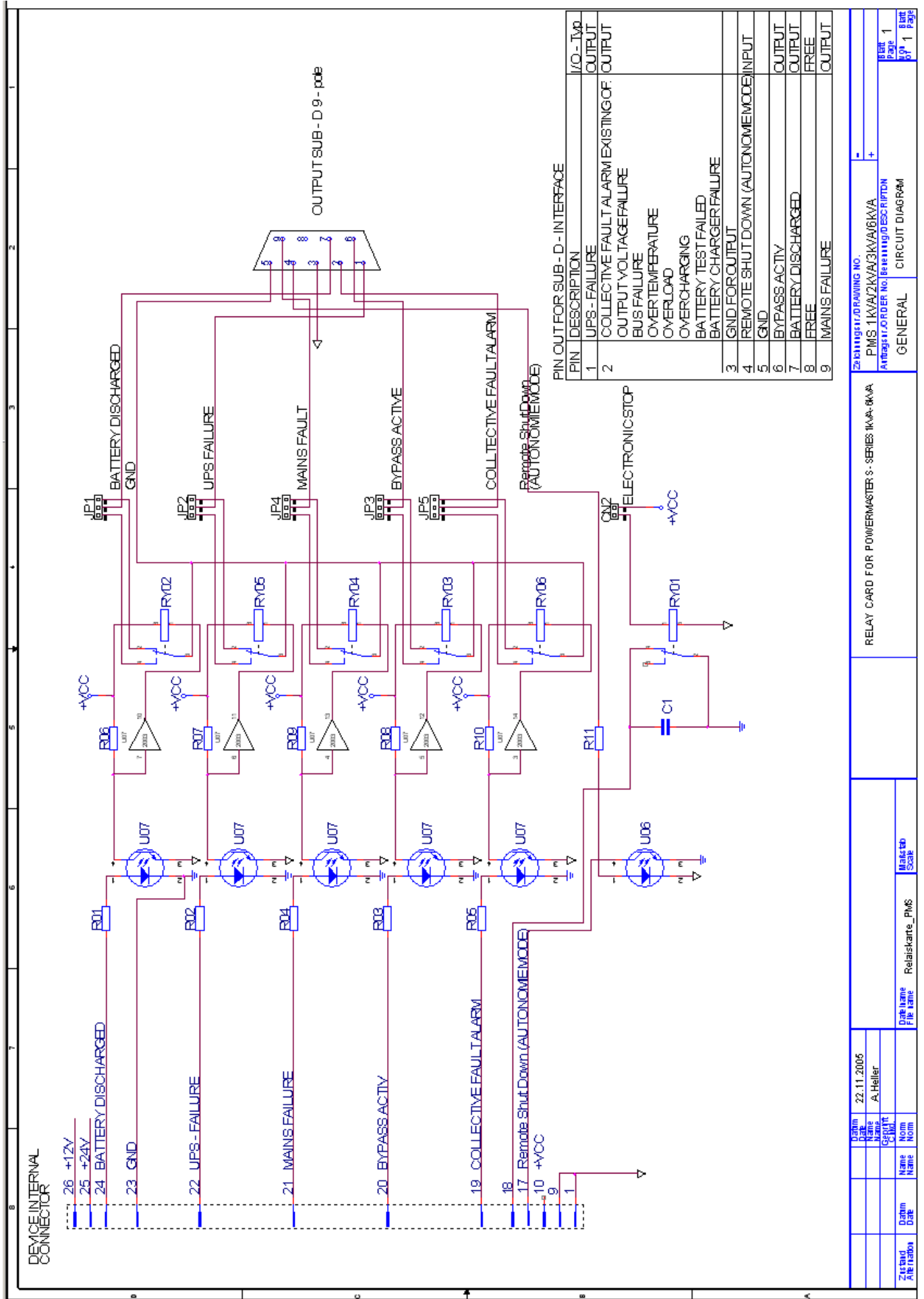

Zelbstgezeichnete Zeichnung No. PMS 1KVA/2KYA/3KYA/6KYA		RELAY CARD FOR POWERMASTER S - SERIES 1KVA-6KVA	
Anteilsort. / Order No. Bezeichnung		RELAY CARD FOR POWERMASTER S - SERIES 1KVA-6KVA	
GENERAL		CIRCUIT DIAGRAM	
Date Name: Relaiskarte_PMS		Master Scale	
Date: 22.11.2005		Name: A. Heller	
Name: A. Heller		Geprüft:	
Name: Norm		Norm:	
Datum:		Datum:	
Zustand:		Zustand:	
Abteilung:		Abteilung:	

13. POWERPACK S 1002**13.1 Extended backup times**

The UPS unit needs two or more battery racks to achieve extended backup times.

The **POWERMASTER S 1002** allows one to switch up to two battery packs in parallel, which results in the following backup times:

Number of slots	Number of batteries	Total weight of battery pack incl. battery	Total weight of UPS + battery pack	Autonomy time at 100% load	Autonomy time at 80% load	Autonomy time at 50% load
UPS	3	No battery pack	17.3 kg (UPS)	10 min.	12 min.	18 min.
1	6	14.4 kg	31.7 kg	20 min.	27 min.	45 min.
1	9	22 kg	39.3 kg	40 min.	49 min.	84 min.
2	12	36.4 kg	53.7 kg	50 min.	72min.	130 min.
2	15	44 kg	61.3 kg	80 min.	93 min	170 min.

PLEASE NOTE!

Before plugging in the battery plug, the voltage at the battery jack on the UPS unit and the battery used must be checked to ensure that they both have the same voltage and polarity. The attached markings (DIRECT CURRENT LINK VOLTAGE) and a control measurement using a suitable measuring device serve to achieve this.

The battery is not galvanically isolated from the mains so occurrence of a mains voltage at the battery terminals is possible. The UPS unit should be disconnected from the mains before working on the battery.

Do not cover the ventilation slits on the battery slots in order to avoid any excessive increase in the battery temperature.

The battery rack should be connected to the mains and switched on at the latest 4 weeks after receipt in order to prevent battery self-discharging.

13.2 Battery operation

In the case of a network failure the consumers are supplied without interruption from the battery.

In battery operation the LED **ON-BAT (Battery operation)** lights up and an acoustic warning tone sounds every 5 seconds. The characteristic of the acoustic warning tone changes towards the end of the backup time, when the battery is depleted, to a double-beep every 5 seconds. The bridging time of a number of minutes generally allows targeted switching off of consumers or data storage/back-up when operating a PC, without losing data or having running processes interrupted in an uncontrolled manner. The bridging time can be extended significantly by switching off individual, less important consumers.

Restoration of mains power before total discharge of the battery:

In the case of restoration of the mains power before the end of the bridging time, the inverter continues to run automatically until the battery is charged up.

Restoration of mains power after total discharge of the battery:

At the end of the bridging time the inverter switches off automatically and the consumers are **no** longer supplied with power.

When the mains power is restored, the consumers begin again to be supplied with power via the inverter. The inverter is switched on again automatically. The battery is charged up again automatically after restoration of the mains power.

13.3 Service life of batteries

Use of closed lead batteries at temperatures above 20°C reduces the expected working life. The table from Eurobatt gives some indication of the approximate working life of the batteries used.

	Nominal working life of batteries		
	10 - 12 years	6 - 9 years	3 - 5 years
Temperature	Expected working life of batteries		
20°C	12 years	9 years	5 years
30°C	5 years	4 years	2.5 years
40°C	2.5 years	2 years	1.25 years

13.4 Instructions for using the batteries

Please observe in this chapter guidelines from the manufacturer for your type of battery.

Data sheets for battery instruction manuals for the batteries in your UPS unit can be found on <http://www.jovyatlas.com/ja/POWERMASTER-S1001-S3002,120-6-2>.

14. Replacing an internal UPS battery

UPS units of the type **POWERMASTER S 1002** offer the option of replacing the battery while operating. One must ensure in this case that the UPS unit is running in normal mode and not in autonomy mode. Proceed as follows to replace the battery:

1. Remove the display panel by pulling off the plastic cover. Pull on the crossover point between the display panel and the ventilation cover.
2. Unhook the display panel. The fastening clip is located on the right hand side next to the grip.
3. Remove the fastening screw on the retaining bracket using a Phillips screwdriver. The fastening screw on the retaining bracket is located on the left side of the battery rack.
4. Unhook the retaining bracket.
5. Pull the battery pack out of the UPS unit using the pulling strap. **Please note that if a power failure occurs now the load will not be supplied with power.**
6. Open the battery pack using a Phillips screwdriver by removing the cross-head screws in the upper area on the left side of the battery pack.
7. You can now replace the batteries.
8. Screw the battery pack together again using the cross-head screws.
9. Push the battery pack into the battery shaft of the UPS unit.
10. Insert the retaining bracket and secure with the cross-head screw.
11. Hook display panel onto the right side of the UPS unit into the retaining tang.
12. Press on display panel evenly until it engages.
13. Conduct a manual battery test to check the battery. **Please note that when conducting the battery test faulty insertion of the battery could mean that the load is not taken over and this will lead to power consumer crashes.**