



BOSCHERT GIZELIS.co

G-ELECTRO
series

SAVE ENERGY

Earth provides enough to satisfy every man's needs, but not every man's greed.

– Mahatma Gandhi



6-ELECTROBEND

5

2D GRAPHICAL CONTROLER

6

PRODUCTIVITY•ACCURACY•SPEED

8

INNOVATIVE DESIGN

9

SAFETY SYSTEM

11

ACTIVE•DYNAMIC ANGLE CONTROL

12

POWERFULL OFFLINE PROGRAMMING

13

OPTIONS

14

TECHNICAL SPECIFICATIONS

16

TOOLING

17

INDUSTRY 4.0

18



PRODUCT RANGE

37



G-ELECTROBEND • SERVO ELECTRIC PRESS BRAKE



Gizelis SA has been manufacturing top-of-the line sheet metal working machinery for over 50 years. Sturdy machine elements and high quality workmanship ensure a lifetime of trouble-free operation. The new line of servo electric press brakes features higher productivity, accuracy and reliability than ever before and in the meantime the operational and maintenance costs are unprecedentedly low. Ram speeds outperform the competition making one of the fastest bending cycle times possible. Overall the new line of Gizelis electric press brakes cost less to own, make your production faster with fewer waste and simply leave you a better profit margin.

ENERGY EFFICIENT

UP TO 50% COMPARED TO CONVENTIONAL HYDRAULIC PRESS BRAKES.

FAST

WITH RAM SPEEDS THAT OUTPERFORM THE COMPETITION.

PRODUCTIVITY

ONE OF THE FASTEST CYCLE TIMES IN THE MARKET. UP TO 35% FASTER CYCLE TIMES THAT HYDRAULIC PRESS BRAKES.

INTRINSICALLY SAFE

THE UPPER BEAM IS MOUNTED ON SPRINGS AND THUS IN THE EVENT OF FAILURE IT MOVES UPWARDS.

USER FRIENDLY

VERY EASY TO COMMISSION AND OPERATE.

EASY TO USE

THE UNIQUE GIZELIS SOFTWARE (under development) OFFERS UTMOST SIMPLICITY EVEN FOR COMPLEX TASKS.

FLEXIBLE

FEATURING 600MM DAYLIGHT AND 350MM STROKE-THE ELECTRICAL PRESS BRAKE IS SUITABLE FOR A VERY WIDE RANGE OF APPLICATIONS.

ENVIRONMENTALLY CONSCIOUS

NO OIL TO LEAK, TO EXCHANGE OR DISPOSE.

2D GRAPHICAL CONTROLLER

INDUSTRIAL CONTROL 2D GRAPHICAL CONTROLLER ESA S660W

The widest touch screen available on press brake CNC, 19" multi touch. A totally renewed interface, specifically designed for multi touch screen. Make the best of any 2D cad cam you would like to install in the CNC.

- FINGER-TIP WORK PIECE DESIGN
- TOOL AND DIE HOLDERS' MANAGEMENT
- ANGLE MEASUREMENT AND CORRECTION WITH ALL EXISTING DEVICES IS AVAILABLE

1. 19" 4:3 HIGH-RESOLUTION TOUCH SCREEN (RESOLUTION SXGA 1280 X 1024)
2. CPU PC: AMD EMBEDDED GX 420 CA 2GHZ, WITH 4GB OF RAM
3. CPU CNC: AMD LX-LX800 500MHZ, WITH 128MB OF RAM
4. FPGA INTEGRATED LOGICS, SURFACE MOUNTING, FIBER OPTIC
5. 24VDC 100W MAX POWER SUPPLY
6. CAPACITIVE TOUCH SCREEN WITH MULTI-TOUCH FUNCTIONALITY
7. ERGONOMIC ALUMINIUM HOUSING, WITH A PANEL SUITABLE FOR MACHINE OPERATIONAL SELECTOR-SWITCHES AND PUSH-BUTTONS
8. 2.5" HARD DISK DRIVE 20GB OR MORE
9. PRESET FOR STANDARD PC KEYBOARD AND MOUSE (PS2 STANDARD CONNECTORS)
10. 1 SERIAL PORTS RS-232, 3 USB PORTS, 2 ETHERNET PORT ON THE PC
11. 2 SERIAL PORTS RS-232, 2 USB, 1 ETHERNET PORT, 1 CAN OPEN PORT ON CNC
12. FIBER OPTIC INTERFACE



PARAMETERS



TOUCHSCREEN CONTROL

2D GRAPHICAL CONTROLLER



BENDING SIMULATION



2D DESIGN



3D DESIGN



2D DESIGN

PRODUCTIVITY • ACCURACY • SPEED

Conventional press brakes use conventional AC motors that rotate continuously and circulate oil by means of a pump and produce hydraulic power that is then used to perform the bending. There are several drawbacks to this system that are eliminated by the use of AC servo motors.

ENERGY CONSUMPTION:

AC servos move only when the ram moves. Conventional hydraulic systems circulate the oil constantly. Electric press brakes consume up to 50% less energy. A conventional press brake working 12 hours/day, 5 days a week consumes approx. 35000 KWh while an equivalent electric press brake approx. 17500 KWh. The KWh price in Europe is approx. 0,2€. This means that owning an electric press brake rather than a conventional one saves up to 3.500€ annually.

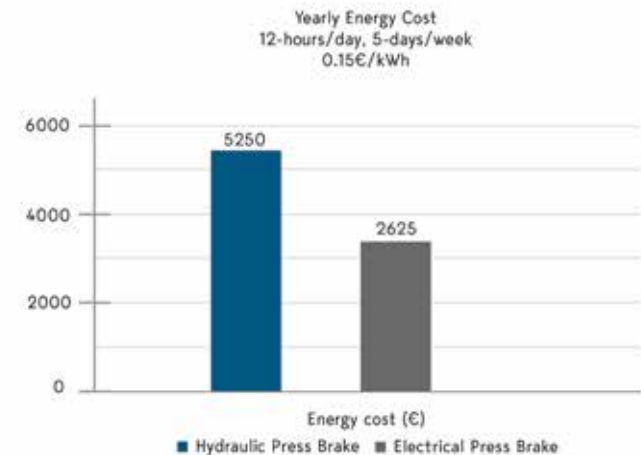
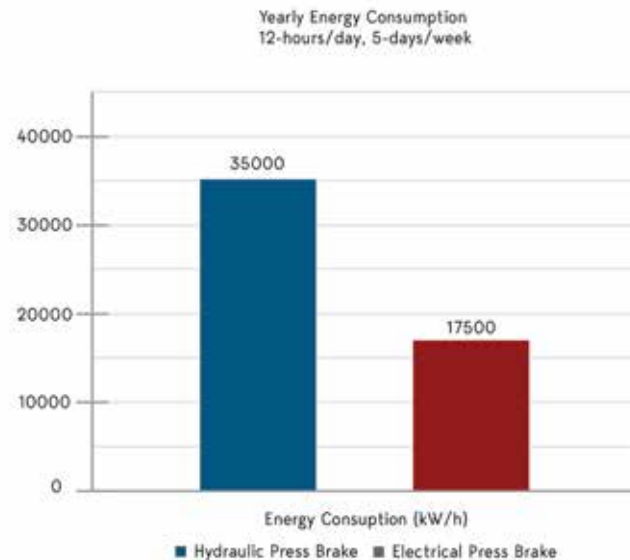

CYCLE TIME:

There are several things that limit the performance of a hydraulic system among which are dwell times etc. This is not the case for AC servos that can change direction and speed almost instantly. This means that the cycle time of the bend can be greatly reduced.

Also the specialized AC servos that Gizelis press brakes utilize feature a unique technology:

There are two windings inside the motor, one that provides very high torque at low rpm (needed for the bend) and one that provides high rpm with low torque (needed during non-bend ram movements). This makes cycle times of the Gizelis press brakes even faster.

INNOVATIVE DESIGN

RIGID O • FRAME

The Gizelis Electric Press Brakes feature a rigid O-Frame that ensures minimum deformation even at full load. Furthermore the O-frame guarantees that the tools do not move laterally to the bend line since there is no horizontal deformation in the frame. Furthermore the position of the ram is controlled by two linear encoders with accuracy of +/- 0.001mm.

These encoders are mounted at a low position on the machine that does not deform at all under load. This makes the measurement of the ram position independent of deformation on the side frame and increases accuracy. Increased accuracy means less waste parts and this in turn makes each part produced actually cheaper to make.

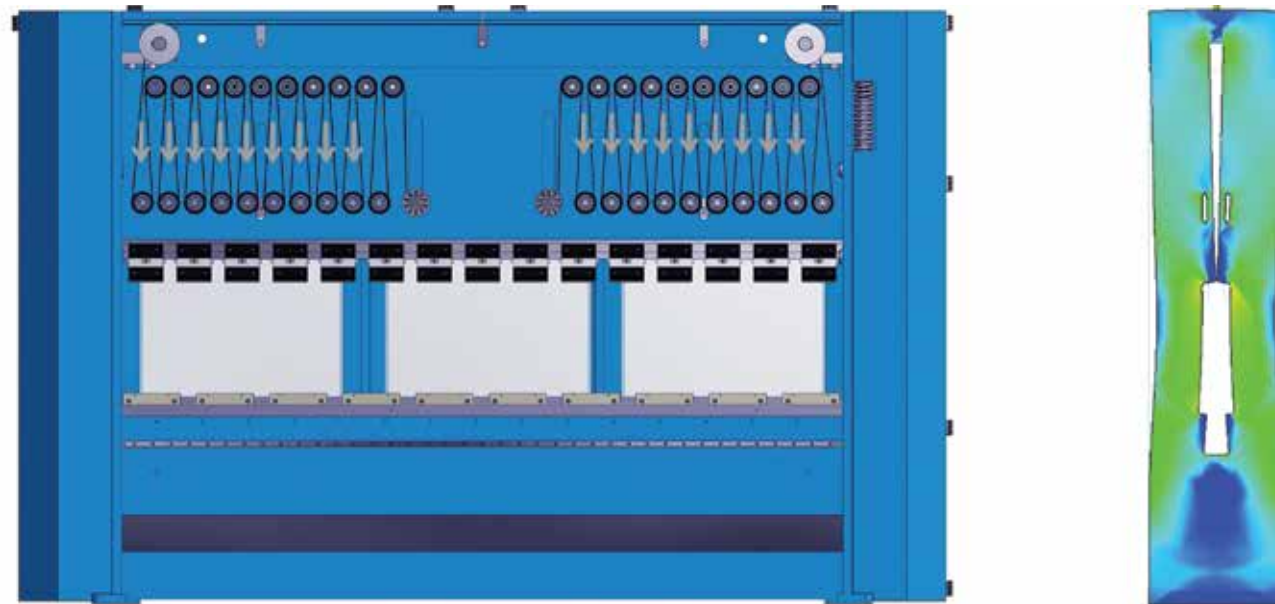

BELT • PULLEY SYSTEM

The inventor of the belt pulley system was the Greek Archimedes and when he made the discovery he said: "Give me a place to stand and I will move the earth". The belt pulley system multiplies the force of the electric motors and makes the production of very large forces possible. Because the force is applied on many evenly spaced points on the ram it makes ram deflection negligible. The rollers feature twin sealed ball bearings and the belt itself is steel cord reinforced. There is no need to maintain/lubricate anything in this system. Ownership cost is thus further decreased.

INNOVATIVE DESIGN

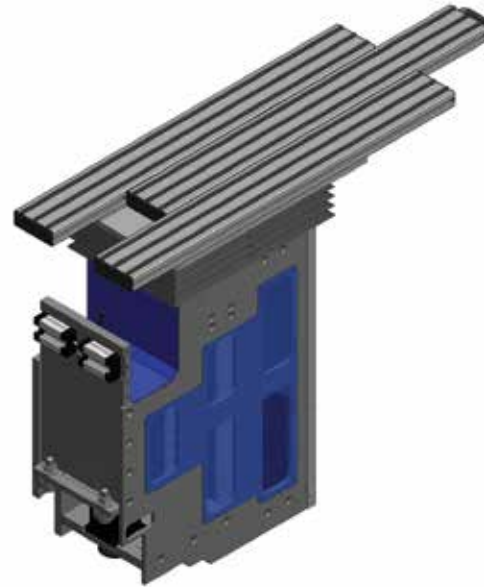

FRONT GAUGE OPTION

Highly flexible, fully automatic bend following

Our company offers a unique front support with bend following capabilities which supplements the Gizelis Electro Brake capabilities in the best possible way. It is obvious that during the bend process of large metal sheets the task of manually supporting the material during the bend is a cumbersome task. Furthermore, especially when the overhanging sheet is moving fast it also poses a risk of injury. Because of these two factors productivity of the machine can be significantly hindered. Gizelis fast, sturdy, fully automatic, bend following front support is the solution. Featuring automatic height adjustment according to die, expandable top supporting surface according to needs, full NC integration and absolute elimination of double bends Gizelis ASF (Automatic Sheet Support) is an asset to any press brake.

X' BACKGAUGE OPTION

The X' axis is illustrated in the below schematic. One of the back gauge fingers has the ability to move back and forth by 400 mm. This is especially useful when manufacturing conical sheet metal parts. The special shape of the fingers facilitates the angular placement of the workpiece in relation to the bend plane.

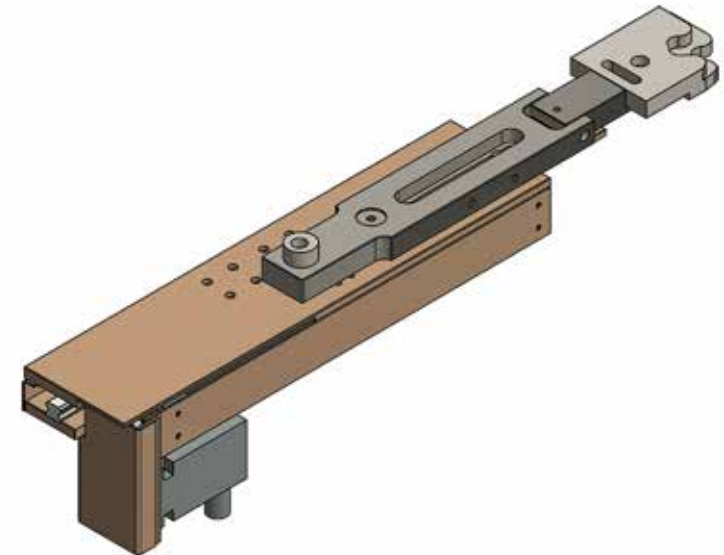

SAFETY SYSTEM

A NEW LEVEL OF MACHINE PRODUCTIVITY AND OPERATOR SAFETY

The Gizelis Electro Brake features the state of the art in optical protection technology. The Lasersafe Rapidbend patented technology enhances machine performance to levels never before possible. A total reduction of 2 seconds is made possible by this unique technology. This represents a significant saving in operating time and cost that can result up to 35% increased productivity.

Optical protection systems with Rapid Bend technology employ a patented progressive muting process that enables the press brake to close safely at high speed until the tool opening is only 6mm. This reduces the slow speed travel distance to enhance machine productivity.

Rapid Bend Plus reduces the speed change point even further from 6mm down to just 2mm to significantly enhance machine productivity, especially in high level production environments.

RapidBend Ultimate eliminates slow speed altogether. The tools close in high speed until the punch reaches the material surface for the ultimate high speed performance.

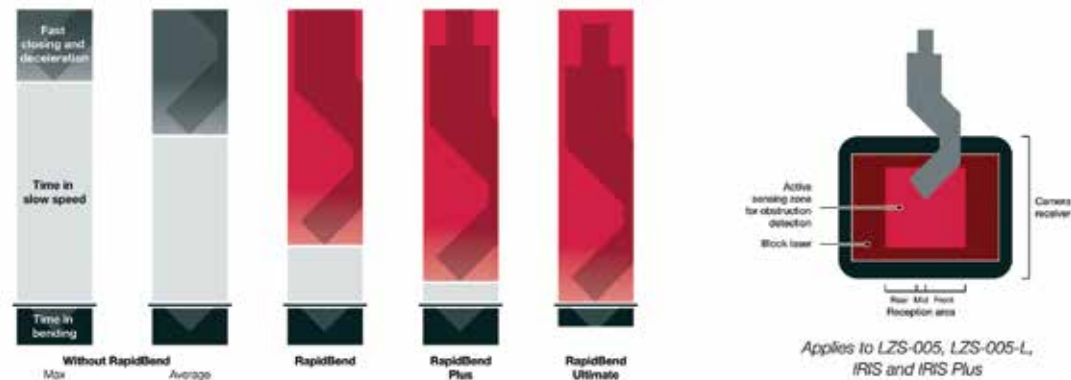

In comparison to other light or laser based guarding systems.

BendShield provides advanced optical protection by enveloping the punch tip with a protective field that has no gaps. BendShield has an object detection resolution of 2mm to detect even the smallest obstruction from any angle.

Optical protection remains active until the tool opening is reduced to 2mm preventing fingers and hands entering the point of operation.

ACTIVE • DYNAMIC ANGLE CONTROL

THE PROBLEM

Manufacturing sheet metal parts with accurate bending angles that are kept constant all times often meets a problem during the actual production process: different parameters in material thickness and stresses. Even materials of the same batch may be significantly different.

Furthermore nesting of parts may induce change in rolling direction of the same part. All these parameters along with machinery tolerances, temperature and lots of other factors contribute to the deviation of the angle of a bend.

THE SOLUTION

The solution to the problem is obvious: real time angle measurement. This solution is elegantly and unobtrusively implemented as far as the sensor is concerned, by Lazersafe's IRIS Plus angle measurement system.

In addition the angle measurement is actually realized by the same digital camera that supervises operator safety. The press brake CNC utilizes the angle data from the digital camera and acts on machine parameters accordingly in order to achieve a final accurate bend angle.

THERE ARE TWO WAYS THAT THIS SYSTEM CAN OPERATE:

↳ **Active Angle Control:** Active Angle Control is designed for single parts or small batch production. During operation the bend is briefly paused prior to reaching the programmed angle while real time images are processed to calculate the material spring back. The bend is then resumed and the spring back calculation is used to automatically control the bending depth. After decompression the final angle is automatically confirmed before proceeding to the next bend. Active Angle Control is a highly accurate angle control process that ensures spring back is calculated for each individual bend to achieve the correct angle.

↳ **Dynamic Angle Control:** Dynamic Angle Control is ideal for high speed processing of volume production parts. When the first part is formed Active Angle Control is initiated to automatically calculate the spring back of each individual bend in the part. After spring back is calculated for the first part then Dynamic Angle Control is activated. Dynamic Angle Control uses real time angle data and the spring back calculation to automatically control the bending depth and the final angle is automatically confirmed after decompression before proceeding to the next bend. Dynamic Angle Control is a high speed process that ensures accuracy and consistency between parts with no delay to the bending operation. There is the possibility to re-calibrate the spring-back calculation by using Active Angle Control at a given time interval or after a specific number of bends. Finally it is important to note that the system offers 100% quality control for bend angle production.

POWERFULL OFFLINE PROGRAMMING

THE PROBLEM • What you design in not what you produce!

WHY? • Because, the unfolding and cutting process does not take under consideration bending parameters (e.g. available tools, tools radius, etc.).

THE SOLUTION • BG-Soft combines the BG-Soft Cut with the BG-Soft Bend into one unified environment. This way every aspect of the manufacturing process (bending and cutting) is considered, that.

WHAT YOU DESIGN IS WHAT YOU GET

BG-Soft Bend is an application for programming and simulating Boschert Gizelis press brakes, used for maximizing production resources. BG-Soft Bend enables offline generation of bending sequences and tooling setups, with dynamic 3D simulation for checking collisions of the part with tools, fingers and machine components.

FEATURES

- Direct part transfer from SolidWorks, Solid Edge and Inventor
- Importing and unfolding of IGES and STEP 3D parts
- Automatic and manual tool selection based on material, machine and tool properties
- Automatic and manual bending sequence with collision detection
- Automatic and manual fingerstop positioning with graphic control of every axis
- Automatic retraction calculation
- 3D simulation of the bending process with collision detection
- Native NC generation enables direct loading of programs to the machine control
- Comprehensive Setup Reports for the machine operator including bend sequence, tooling and bend-by-bend graphics

ADVANTAGES

BG-Soft Bend enhances your productivity because:

- Faster design-to-production time with automated features
- Offline programming means minimum machine downtime
- Collision-free bending sequences mean reduced stock wastage
- BG-Soft Bend's tool library is compatible with the tooling available resulting in ready-to-be-produced Setup Reports

3D SIMULATION AND COLLISION DETECTION

EFFICIENT TOOL SELECTION

BENDING SEQUENCE SELECTION

FINGERSTOPS POSITIONING

- Comprehensive Setup Reports include:**
- Bending sequence instructions
 - Tool setup details
 - Product handling
 - Bend-by-bend graphics
- SETUP REPORTS**

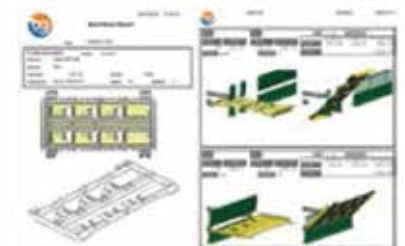
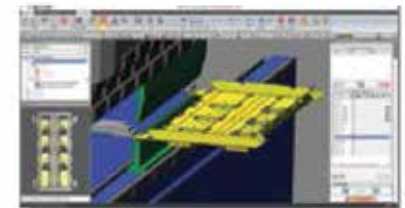
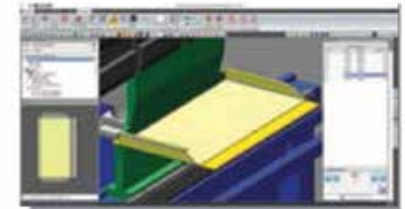

OPTIONS

2-axis back gauge, X-R



5-axis back gauge,
X-X'-R-Z1-Z2



4-axis back gauge,
X-R-Z1-Z2



CNC Front support
(CNC bending aid)



Heavy-duty front supports, moveable on linear guide, height adjustable
(2 pieces)



ROL200, Fast mechanical clamping with vertical tool exchange
(standard tools/no tool modification required)



ROL200PN, Fast pneumatic upper-tool clamping with vertical tool exchange
(standard tools/no tool modification required)



Hydraulic clamping for upper & lower tooling, WILA-Premium/Pro Version

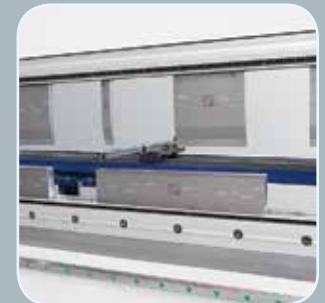

CNC-controlled anti-deflection system
(crowning)



Manually Measuring Bending Angle and Bending Program Correction



TECHNICAL SPECIFICATIONS

		G ELECTROBRAKE ® 2060	G ELECTROBRAKE ® 2580	G ELECTROBRAKE ® 3100
Bending force	tons	60	80	100
Working Length	mm	2100	2600	3100
Distance between uprights	mm	2150	2650	3150
Daylight	mm	600	600	600
Punch stroke	mm	350	350	350
Table width	mm	84	84	84
Fast speed	mm/sec	120	120	120
Working speed	mm/sec	20*	20*	20*
Upstroke speed	mm/sec	100	100	100
Power	kW	2x6.5	2x8.4	2x8.4
Length	mm	3100	3600	4100
Width	mm	1650	1650	1650
Height	mm	2670	2670	2670
Weight (approximate)	kg	5750	6550	7500

*Working speed is limited according to safety regulations for CE countries

TOOLING

		42 kg/mm ²																					
S mm	4	5	6	8	10	12	16	20	25	32	40	50	63	80	100	125	160	200	250	V	B	Ri	
	0.5	0.7	0.8	1	1.3	1.5	2	2.5	3.2	4.4	5	6.5	8	10	12	15	20	25	37				
0.6	6	5	3	2																			
0.8	12	9	7	5	4																		
1		15	11	8	6	5																	
1.2			18	12	9	7	5																
1.5				21	15	12	8	6															
2					30	23	16	12	9														
2.5						39	27	20	14	11													
3							43	31	23	16	12												
4								60	44	32	23	18											
5									76	54	39	29	22										
6										85	62	45	33	25									
8											121	88	70	46	35								
10												151	109	79	58	44							
12													173	124	91	66	50						
15														213	155	113	81	62					
20															302	220	158	115	89				
25																378	269	197	144			Ft/m	

30°	Bx1.6	R=20kg/mm ²	rx0.8
60°	Bx1.1		
90°	Bx1	R=42kg/mm ²	rx1
120°	Bx0.9		
150°	Bx0.7	R=70kg/mm ²	rx1.4

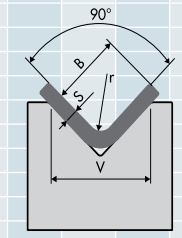

**ERGONOMIC TOOL CABINET
IN ORDER TO KEEP
YOUR TOOLING
SAFE AND ORGANIZED**

		70 kg/mm ²																					
S mm	4	5	6	8	10	12	16	20	25	32	40	50	63	80	100	125	160	200	250	V	B	Ri	
	0.5	0.7	0.8	1	1.3	1.5	2	2.5	3.2	4.4	5	6.5	8	10	12	15	20	25	37				
0.6	10	8	6	4																			
0.8	20	15	12	8	6																		
1		25	19	13	10	8																	
1.2			30	21	15	12	8																
1.5				35	26	20	13	10															
2					50	38	26	19	15														
2.5						66	45	33	24	18													
3							71	52	38	27	21												
4								101	73	53	38	30											
5									126	90	66	48	37										
6										142	103	76	55	42									
8											202	147	117	77	59								
10												252	182	131	96	74							
12													288	207	151	110	83						
15														354	258	189	135	104					
20															504	367	263	192	148				
25																603	448	328	240			Ft/m	

30°	Bx1.6	R=20kg/mm ²	rx0.8
60°	Bx1.1		
90°	Bx1	R=42kg/mm ²	rx1
120°	Bx0.9		
150°	Bx0.7	R=70kg/mm ²	rx1.4

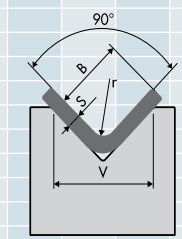



INDUSTRY 4.0

WHAT IS INDUSTRY 4.0?

As INDUSTRY 4.0, is defined the rise of new digital industrial technology, a transformation that makes possible to gather and analyze data across machines.

INDUSTRY 4.0 PRINCIPLES:

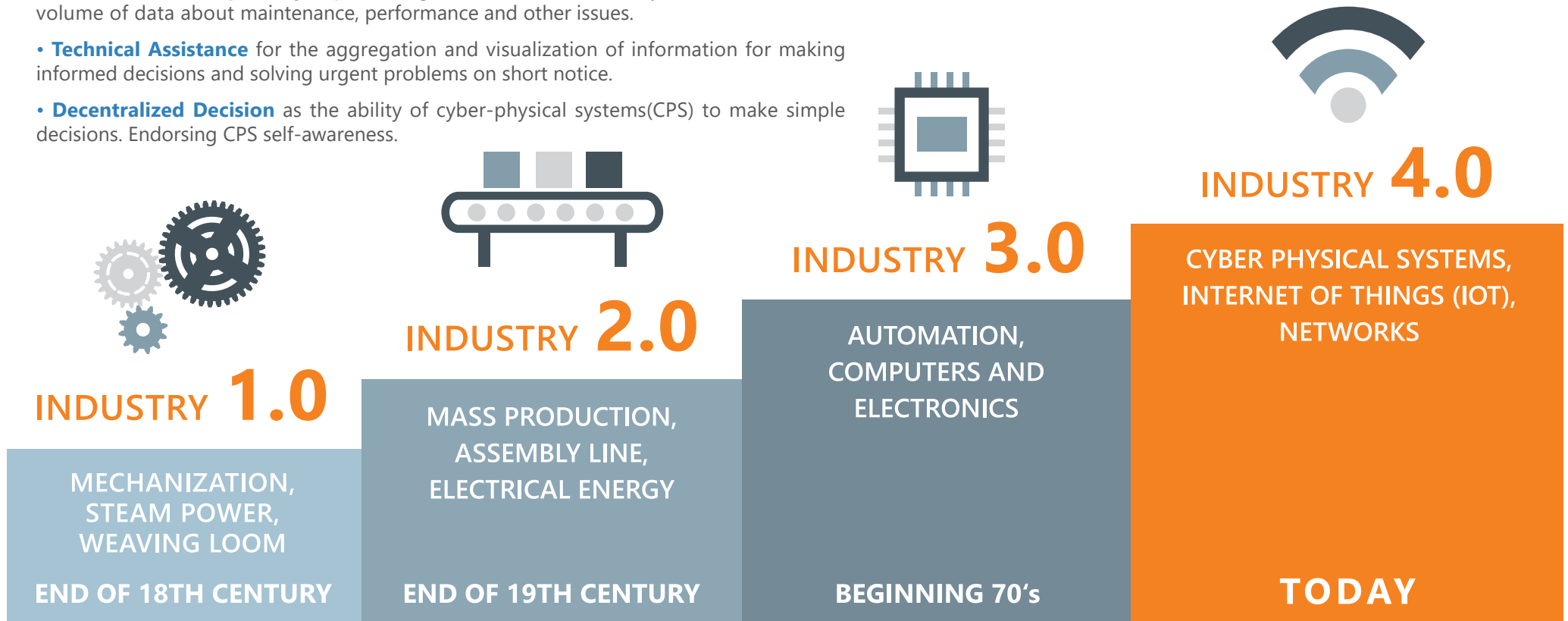
- **Interconnection** of machines, devices, sensors and people via the Internet of Things (IoT).
- **Information Transparency** is permitting the collection and analysis of a tremendous volume of data about maintenance, performance and other issues.
- **Technical Assistance** for the aggregation and visualization of information for making informed decisions and solving urgent problems on short notice.
- **Decentralized Decision** as the ability of cyber-physical systems(CPS) to make simple decisions. Endorsing CPS self-awareness.



BOSCHERT GIZELIS G-ELECTROBEND & INDUSTRY 4.0



Easy Implementation of Client Applications

- Data availability is implemented according to international standards

Easy Access to Data

- All information collected in a SQL database
- Connectivity to ERP systems, according to standards

Easy Connection to Current Infrastructure

- Integrated WiFi – No need for cables

Easy to Use

- Graphical Data representation
- Graphic Only user interface - language independent

Secure Password Protected and Encrypted Connection

BOSCHERT GIZELIS G-ELECTROBEND APPLICATION

The G-ELECTROBEND is equipped with the Boschert Gizelis Monitor App. Providing the production statistics, current status of the production cycle and alarm events:

- Number of produced pieces
- Characteristics per working cycle (tonnage per cycle, piece thickness etc.)
- Cycle times
- Power consumption
- Machine's Current status (maintenance, alarm, automatic etc.)
- Alarms and Warnings

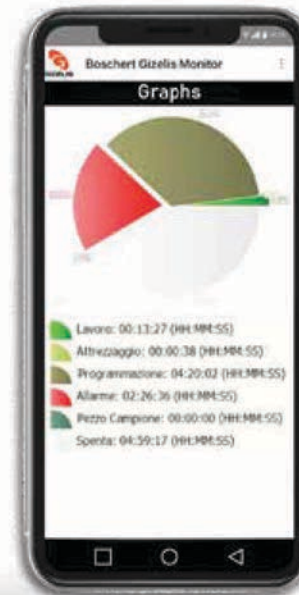

Width	Thickness	Material	Back Gauge Pos	Bend Time	Repeats
5 ton	500 mm	2 mm	iron type 1	5 sec	10
			X2(50mm)		
			R1(100mm)		
			R2(150mm)		
			Z1(80mm)		
			Z2(50mm)		

RESULTS:

- Maintenance management
- Precise prediction of machine's health, to gain near-zero downtime
- Instant warning in the case of malfunction



REMOTE SERVICES

Boschert Gizelis provides the ability to remote access the G-ELECTROBEND.



PROVISION OF REMOTE SERVICES:

- Allows the study of collected data to provide a thoughtful solution, before the arrival of our technical staff.
- Reduces the Service response time.
- Permits the remote update of the software and Graphical User Interface (GUI).
- Eliminates the need of physical presence of the technical staff on the factory.

GIZELIS ELECTRIC MACHINES

GIZELIS ELECTRIC MACHINES MEANS:

PAY LESS

- Save up to 50% on energy compared to press brake
- High reliability. No downtime. Only very simple components like bearings, flat belts and gearboxes are involved in ram movement
- Very low maintenance. Simple components without maintenance needs
- Less scrap because of high repeating accuracy achieved by:
 - Uniform deflection of O-frame
 - Servo driven upper ram
 - No oil - no thermal interference

EARN MORE

Increase productivity by up to 35% with:

- High ram speeds. Highest ram speeds in the market for electric machines
- Very high ram acceleration - deceleration. Unique servo motor technology
- Shortest possible change of high to low speed with RapidBend Ultimate
- Quick change tooling system, customizable UI, offline programming etc

SAVE THE PLANET

- Less energy used - reduced CO2 emissions
- Absence of oil - less scrap
- High reliability - less spare parts production



PRODUCT RANGE

➔ Boschert-Gizelis' combined product range covers a large variety of machines, necessary for the sheet-metal processing industry, such as press brakes, shears, punching and notching machines, combined machines, portal type oxy and plasma cutting as well as laser-cutting machines. On top of these, Boschert-Gizelis Group can manufacture specially-made machines upon request.



GFLXH



GBEND
plus



HD



GSTURBOBEND



GSCUT

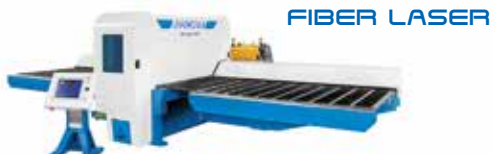

FIBER LASER



MULTIPUNCH



G-ELECTROBEND



G-ELECTROCUT

↘ **Teleservice** 5 days a week
↘ **Service Stations** covering major geographical areas:

- ↘ Germany
- ↘ Greece
- ↘ France
- ↘ Poland
- ↘ Croatia (Balkan Countries)
- ↘ Russia
- ↘ India
- ↘ Thailand
- ↘ USA
- ↘ GCC countries
(Bahrain, Kuwait, Oman, Qatar, Saudi Arabia, UAE)

AFTER SALES SERVICE

One Group
One Deal
One Service Center
One Partner

SAVE ENERGY

SAVE ENERGY



G6-ELECTROBEND



G6-ELECTROCUT

BOSCHERT GIZELIS.co

BOSCHERT GMBH & CO. KG

Mattenstr.1
79541 Lörrach
T: +49 7621 9593-0
F: +49 7621 55184
E: info[a]boschert.de

GIZELIS S.A.

Schimatari Viotias, 32009
Kormatzini Area, Greece
T: +30 22620 58675
F: +30 22620 57185
E: info[a]gizelis.gr