

Standard display formats:  
1, 2, 3, 4 or 8 variables  
some with bargraphs.

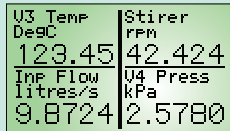

Some of the standard screens

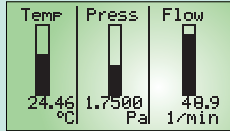
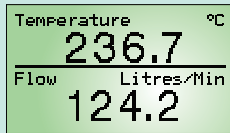
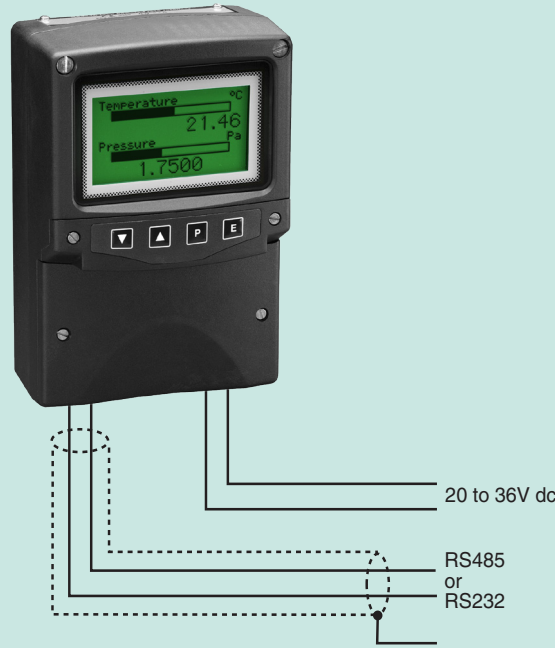

The **BA684D** is a dc powered instrument that can display text and simple graphics in a process area. Incorporating four push-buttons and two single pole outputs, the BA684D is a low cost robust operator interface ideal for simple machine and process control applications.

Available with either an **RS485** or **RS232** port and incorporating Modbus RTU, BEKA and Legacy protocol, the BA684D may be directly connected to many industrial networks and instruments, including new installations and upgrades to existing systems.

A **high contrast liquid crystal display** incorporates a green backlight allowing the display to be read in all lighting conditions from full sunlight to total darkness. The BA684D text display is therefore suitable for mounting in almost any process location.

**Four push-buttons**, which may be used for operator acknowledgments or controls, are mounted on the instrument front panel below the display. If larger industrial switches are required for operator acknowledgements, these may be connected to the text display terminals. When external switches are activated, the front panel push-buttons are automatically disabled.

**Two switch outputs**, which are controlled via the serial data link, may be used to control a small load such as a valve, actuator or sounder.

**Standard screen formats** contain one, two, three, four or eight variables, together with units of measurement, tag descriptions and bargraphs on some of the screens. Use of one of these eleven standard screens greatly reduces the amount of programming required and will satisfy most display requirements. If a custom display format is required, this can be developed using BEKA protocol.

The **BA684D** is a **Modbus RTU slave** that can display up to eight process variables together with units of measurement and tag descriptions. When used with one of the eleven standard screen formats, no programming is required apart from setting the BA684D communication parameters and writing each Modbus variable into the

BA684D Modbus register address map. If a custom screen layout is required in a Modbus system this can be constructed using the BEKA protocol.

**BEKA protocol** allows custom screens using five different font sizes together with, lines, boxes and bargraphs to be produced and stored in non-volatile memory. Simple bit map graphics may be downloaded and stored. Information can also be written to a hidden screen that may be displayed when required.

**Legacy protocol** enables the BA684D to replace an MTL643 for safe area applications without the need for a galvanic communications isolator and with the added advantage of a display backlight. If required, simple modifications to the host software will allow the enhanced features of the BA684D to be used i.e. five font sizes, simple graphics, additional operator buttons and a second solid state output.

**Scripts** are a sequence of commands, downloaded to and stored in non-volatile memory by the BA684D text display, that can be executed by the instrument without intervention from the host. For example, a routine may be written to monitor the instruments push-buttons and to change the displayed screen or variable depending upon which button has been operated.

**Pattern matching** is a powerful feature that allows the BA684D to capture and display data contained in a proprietary ASCII serial string, such as that from a weighing system or barcode reader primarily intended for printing.

**The robust enclosure** which is moulded in glass reinforced polyester (GRP), has stainless steel fittings, silicone gaskets and an armoured glass window. Its robust construction provides IP66 protection. A separate terminal compartment allows the BA684D to be installed and terminated without exposing the display electronics.

**To simplify system design** the instruction manual is supplemented by comprehensive Modbus and programming guides plus a free instrument simulator which will run on a PC. All are available from the BEKA sales office or may be downloaded from [www.beka.co.uk](http://www.beka.co.uk)

# BA684D

## Modbus RTU display

## Serial Data display

### General purpose

- ◆ High contrast display with backlight.
- ◆ Modbus RTU slave
- ◆ BEKA and Legacy protocols.
- ◆ 11 standard screen formats.
- ◆ Four operator push-buttons & two switch outputs.
- ◆ IP66 field mounting GRP enclosure.
- ◆ Free simulator and ScreenWriter software.
- ◆ 3 year guarantee

[www.beka.co.uk/ba684d](http://www.beka.co.uk/ba684d)

# BEKA

## associates

BEKA associates Ltd. Old Charlton Rd.  
Hitchin, Hertfordshire, SG5 2DA, U.K.  
Tel. (01462) 438301 Fax (01462) 453971  
e-mail [sales@beka.co.uk](mailto:sales@beka.co.uk) [www.beka.co.uk](http://www.beka.co.uk)

## SPECIFICATION

### Power supply

Voltage	20 to 36V dc
Current	95mA max

### Display

Type	120 x 64 pixel backlit liquid crystal
Size	86.5 x 45mm
Screens	11 standard formats 1, 2, 3, 4 or 8 variables plus units of measurement & tag information, some include bargraphs.
Custom format	See Programming Guide
Hidden screen	ASCII character set, 5 font sizes May be written to at any time and displayed when required.

### Controls

Front panel	Four push-buttons which can be software interrogated.
External switches	Control may be transferred to six external switches, front panel buttons are inhibited.
Switch cable length	5m max

### Outputs

Rating	Two software controlled single pole relay contacts 250V; 5A ac 30V; 5A dc Reactive loads must be suppressed
--------	--

### Data transmission

Speed	0.3, 0.6, 1.2, 2.4, 4.8, 9.6, 19.2, 38.4, 67.6 & 115.2k bps.
Format	1 or 2 stop bits; odd, even or no parity bit; 7 or 8 data bits.
Protocol	Selectable Modbus RTU, BEKA or Legacy that is compatible with the MTL643 & MTL644
Address	1 - 247 Modbus protocol 0 - 247 BEKA protocol 0 - 15 Legacy protocol Zero reserved for single instrument applications

### Environmental

Operating temp	-20 to 60°C
Storage temp	-40 to 85°C
Humidity	To 95% @ 40°C
Enclosure	IP66
EMC	In accordance with EU Directive 2004/108/EC.
Immunity	No error for 10V/m field strength between 150kHz and 1GHz.
Emissions	Complies with the requirements for Class B equipment

### Mechanical

Terminals	Screw clamp for 0.5 to 1.5mm <sup>2</sup> cable.
Weight	1.6kg

### Accessories

Stainless legend plate	Stainless steel plate etched with tagging or applicational information secured to the front of the instrument
Pipe mounting kit	BA392D or BA393
Modbus Guide	] May be downloaded from <a href="http://www.beka.co.uk">www.beka.co.uk</a>
Programming Guide	
Instrument simulator	

## HOW TO ORDER

Model number	<b>Please specify</b> BA684D
Communication port	RS485 or RS232

<b>Accessories</b>	<b>Please specify if required</b>
Stainless legend plate	Legend
Pipe mounting kit	BA392D or BA393
Modbus Guide	Serial Text Display - Modbus Guide
Programming Guide	Serial Text Display - Programming Guide
Instrument simulator	Instrument simulator for personal computer
BEKA ScreenWriter	Custom screen design aid for personal computer

## DIMENSIONS (mm)

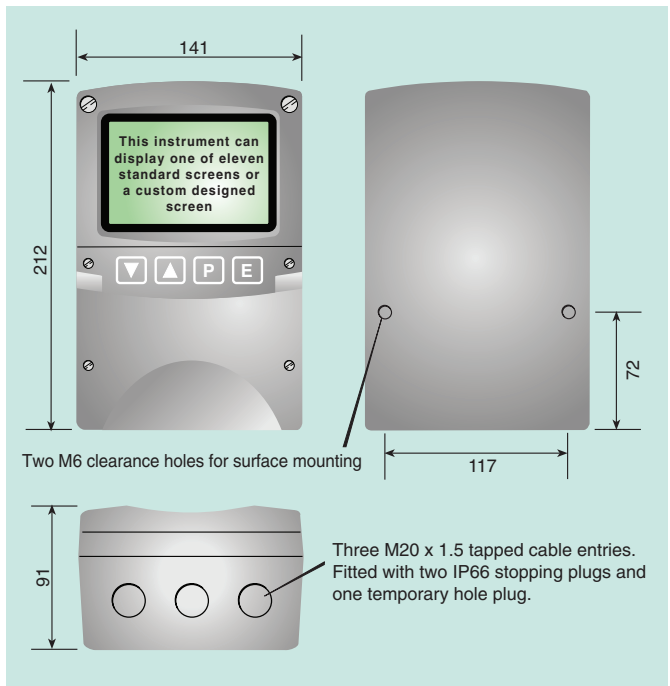

## TERMINAL CONNECTIONS

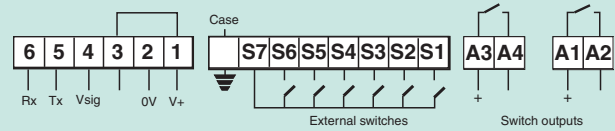

## CONNECTION

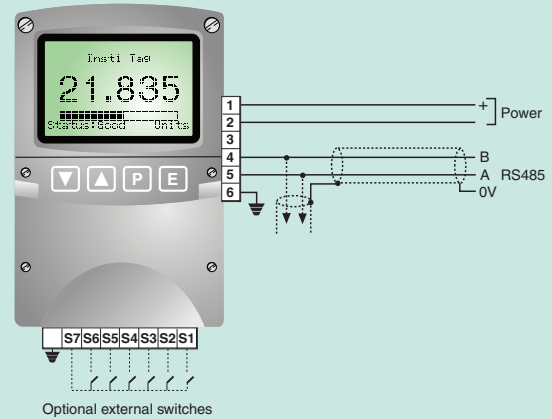

Connections for RS485 communication

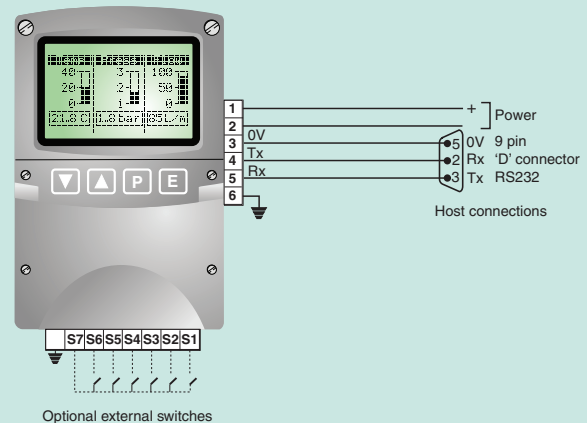

Connections for RS232 communication