

# PNEUMATIC VALVES | Brass Heavy Duty

## PE Valves | Air Operated

### PE Series

- Heavy duty brass valves, air operated
- 3/2, 5/2, 5/3
- Port size : 1/4" & 1/2" BSP & NPT

### Application

- Suitable for use in aggressive environments such as mining, cement manufacturing and flour milling industries.

### Technical Data

Fluid	Air / Inert gas / Water
Operation pressure	-1 to 10 bar
Ambient temperature	-5° to 55° C (option for FKM seals) up to 150° C
Lubrication	Not required (use turbine oil class ISO VG32 if lubricated)
Port size	1/4" & 1/2" BSP or NPT
Flow rate (Air)	1/4" port size = 1,100 L/min (at 5.5 bar) 1/2" port size = 3,500 L/min (at 5.5 bar)
Minimum pilot pressure	Air-Air : 2.5 bar Air-Spring : 3 bar Air-Dif : 2.5 bar Cyl-Cyl : 0.5 bar Cyl-Spring : 0.7 bar



Dif Pres for Air Assy



Air-Spring



Cyl-Dif



Cyl-Spring



AIR-AIR

Construction

3 port Air-Spring valve

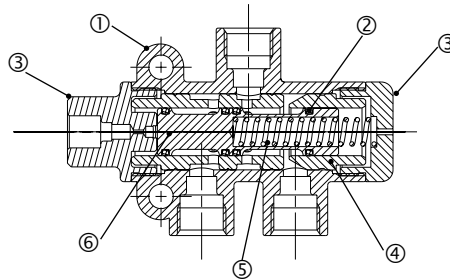

5 port Air-Air valve

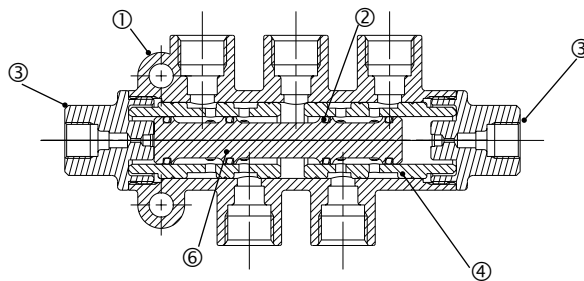

5 port, 3 Position Air-Air valve

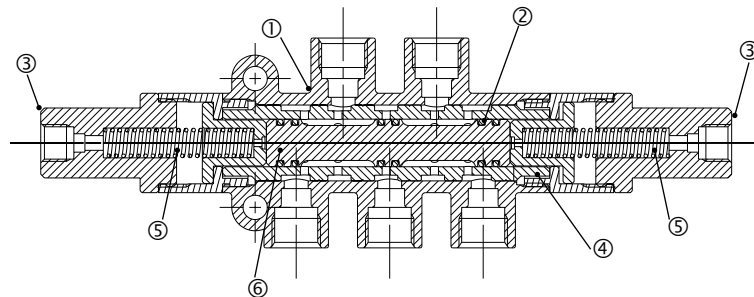

Component Parts

No.	Description	Material
1	Body	Brass *
2	"O" ring	NBR or FKM
3	End cover	Brass
4	Sleeve	Brass
5	Spring	-
6	Spool	Brass

\* Painted with grey polyester

# PNEUMATIC VALVES | Brass Heavy Duty

## PE Valves | Air Operated

### PEA3-S | Air-Spring | 1/4", 1/2" 3 port

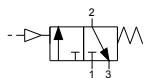

Port size : 1/4"

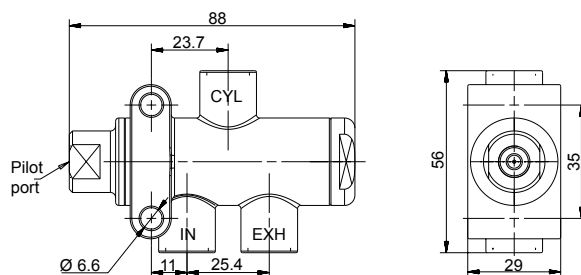

Port size : 1/2"

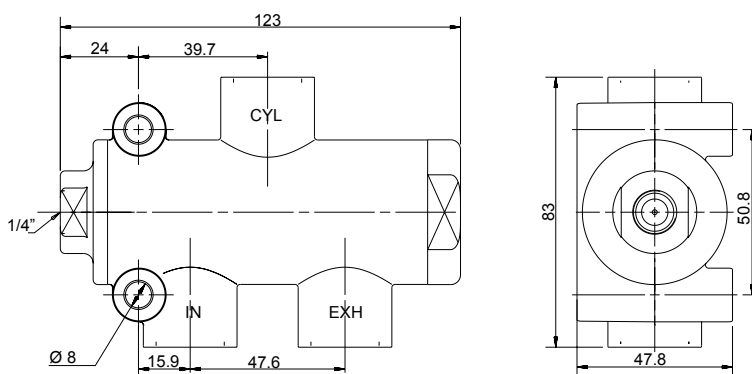

### How to Order

PEA3	-	PORT SIZE	-	S	-	SEAL MATERIAL	-	PILOT PORT SIZE <sup>(1)</sup>
		1/4" BSP		0		NBR		1/8" BSP
		1/4" NPT		1		FKM		1/4" BSP
		1/2" BSP		2				1/4" NPT
		1/2" NPT		3				

(1) Applicable for 1/4" valve only

PEA5-S | Air-Spring | 1/4", 1/2" 5 port

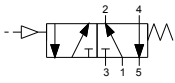

Port size : 1/4"

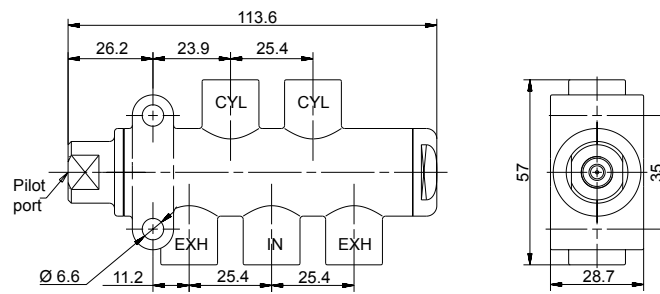

Port size : 1/2"

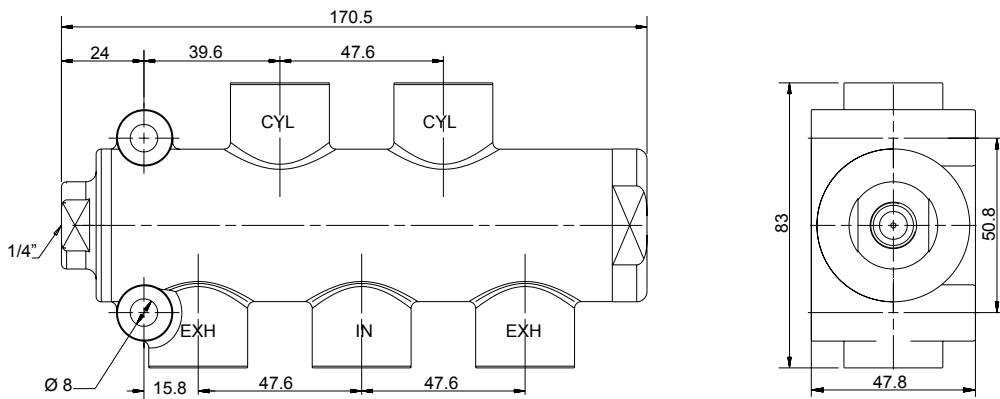

How to Order

PEA5	-	PORT SIZE	-	S	-	SEAL MATERIAL	-	PILOT PORT SIZE <sup>(1)</sup>	
		1/4" BSP		0		NBR	N	1/8" BSP	0
		1/4" NPT		1		FKM	V	1/4" BSP	1
		1/2" BSP		2				1/4" NPT	2
		1/2" NPT		3					

(1) Applicable for 1/4" valve only

# PNEUMATIC VALVES | Brass Heavy Duty

## PE Valves | Air Operated

### PEA3-D | Air-Air | 1/4", 1/2" 3 port

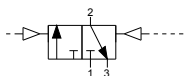

Port size : 1/4"

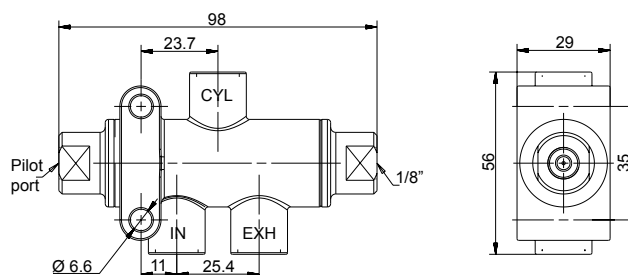

Port size : 1/2"

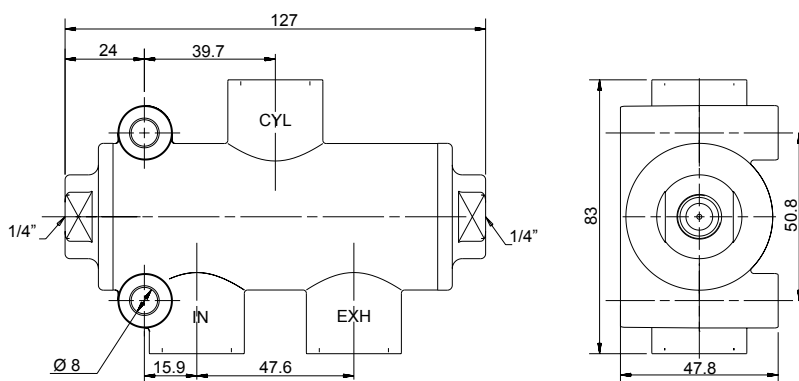

### How to Order

PEA3	-	PORT SIZE	-	D	-	SEAL MATERIAL	-	PILOT PORT SIZE <sup>(1)</sup>	
		1/4" BSP		0		NBR	N	1/8" BSP	0
		1/4" NPT		1		FKM	V	1/4" BSP	1
		1/2" BSP		2				1/4" NPT	2
		1/2" NPT		3					

(1) Applicable for 1/4" valve only

PEA5-D | Air-Air | 1/4", 1/2" 5 port

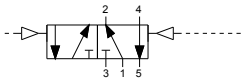

Port size : 1/4"

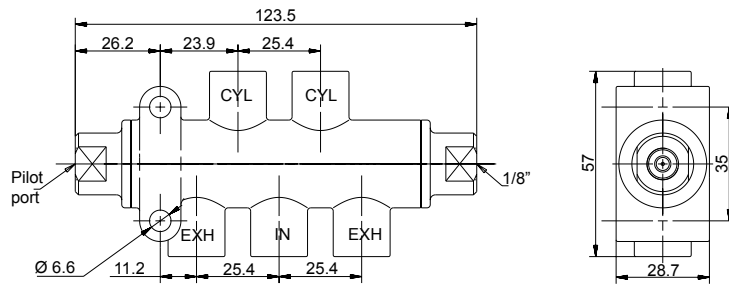

Port size : 1/2"

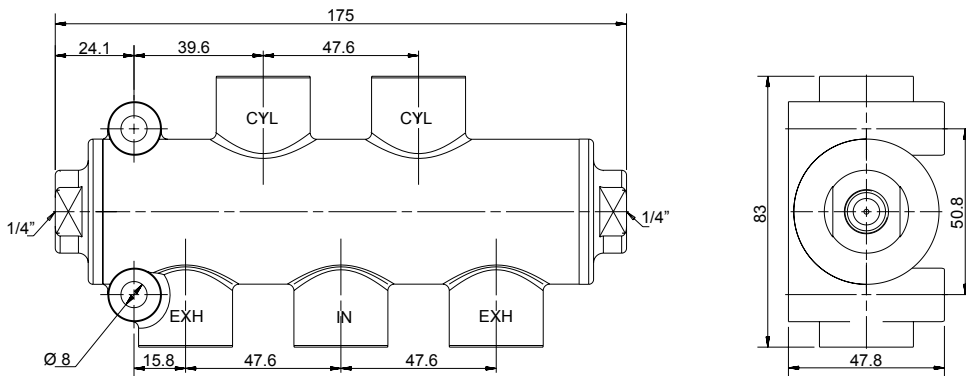

How to Order

PEA5	-	PORT SIZE	-	D	-	SEAL MATERIAL	-	PILOT PORT SIZE (1)
		1/4" BSP		0		NBR	N	1/8" BSP
		1/4" NPT		1		FKM	V	1/4" BSP
		1/2" BSP		2				1/4" NPT
		1/2" NPT		3				

(1) Applicable for 1/4" valve only

# PNEUMATIC VALVES | Brass Heavy Duty

## PE Valves | Air Operated

### PEA-DF | Air-Differential | 1/4" 3 & 5 port

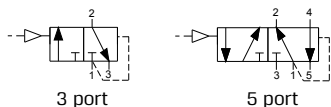

Function : 3 port

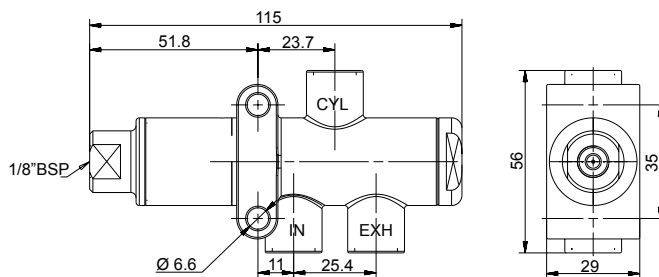

\*Image is 5/2 valve

Function : 5 port

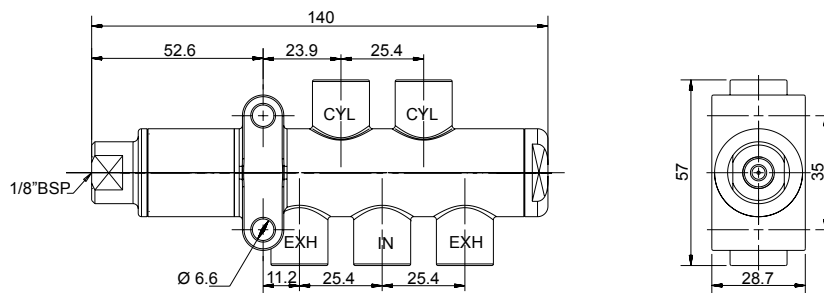

### How to Order

PEA	-	PORT SIZE	-	FUNCTION	-	DF	-	SEAL MATERIAL
		1/4" BSP		0	3 port	3		NBR N
					5 port	5		FKM V

PEA-S | Cyl-Spring | 1/4" 3 & 5 port

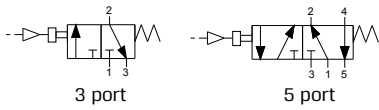

Function : 3 port

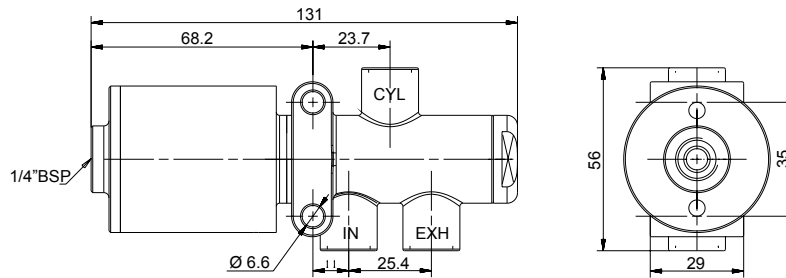

\*Image is 5/2 valve

Function : 5 port

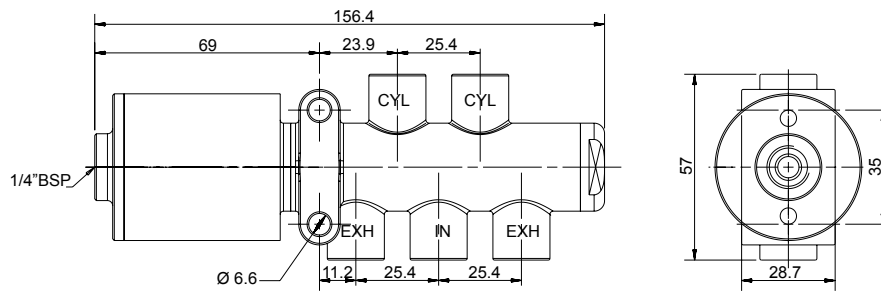

How to Order

PEA	-	PORT SIZE	-	FUNCTION	-	S	-	SEAL MATERIAL
		1/4" BSP		0	3 port	3		NBR N
					5 port	5		FKM V



# PNEUMATIC VALVES | Brass Heavy Duty

## PE Valves | Air Operated

### PEA-DF | Cyl-Dif | 1/2" 3 & 5 port

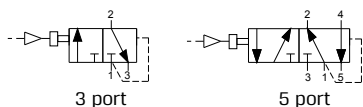

Function : 3 port

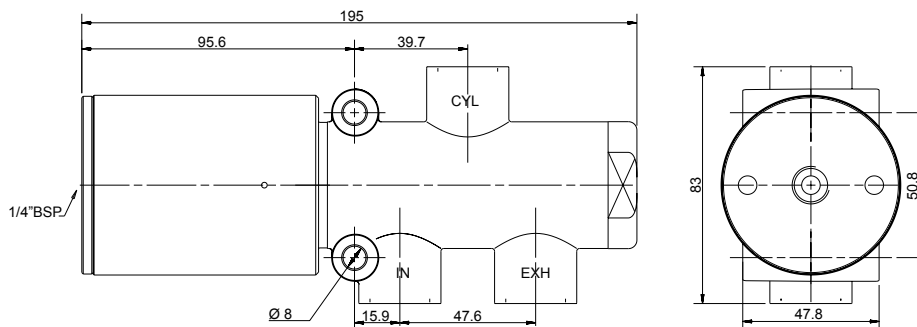

\*Image is 3/2 valve

Function : 5 port

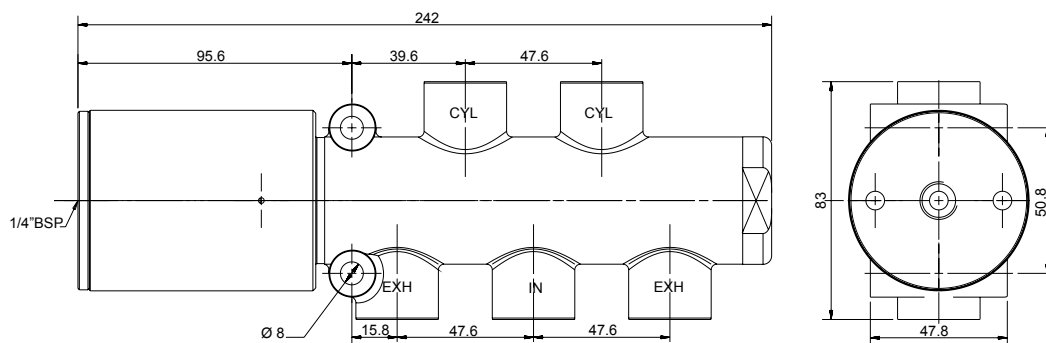

### How to Order

PEA	-	PORT SIZE	-	FUNCTION	-	DF	-	SEAL MATERIAL
		1/2" BSP		2		3 port		3 NBR N
						5 port		5 FKM V

**PEA5-P** | 3 Position Closed Center | Air-Air | 1/4" 5 port

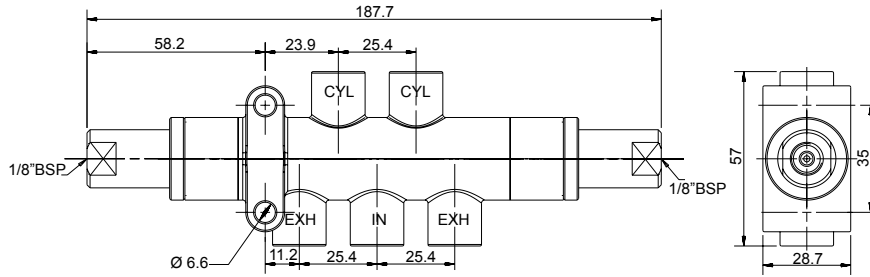
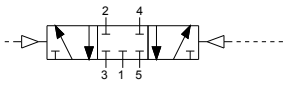

**PEA5-U** | 3 Position Exhaust Center | Air-Air | 1/2" 5 port

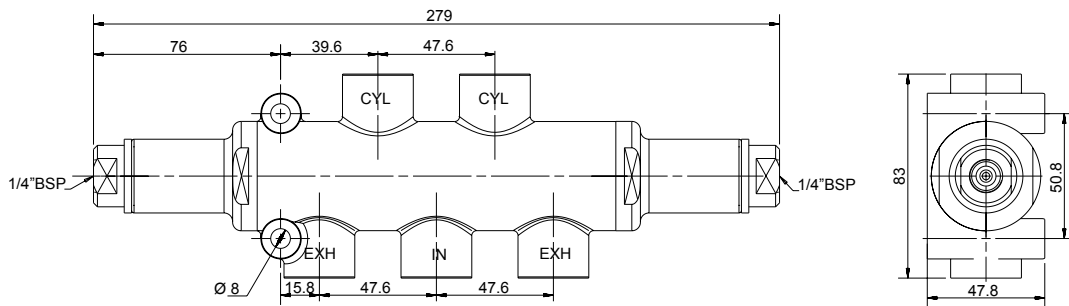
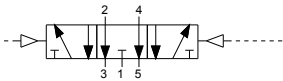

How to Order

PEA5	PORT SIZE	FUNCTION	SEAL MATERIAL
	1/4" BSP	0	NBR
	1/2" BSP	2	FKM
		Center	N
		Exhaust	V
		Center	