

INKBIRD

SMART HOME SMART LIFE

SMART SPRINKLER CONTROLLER

IIC-800-WIFI

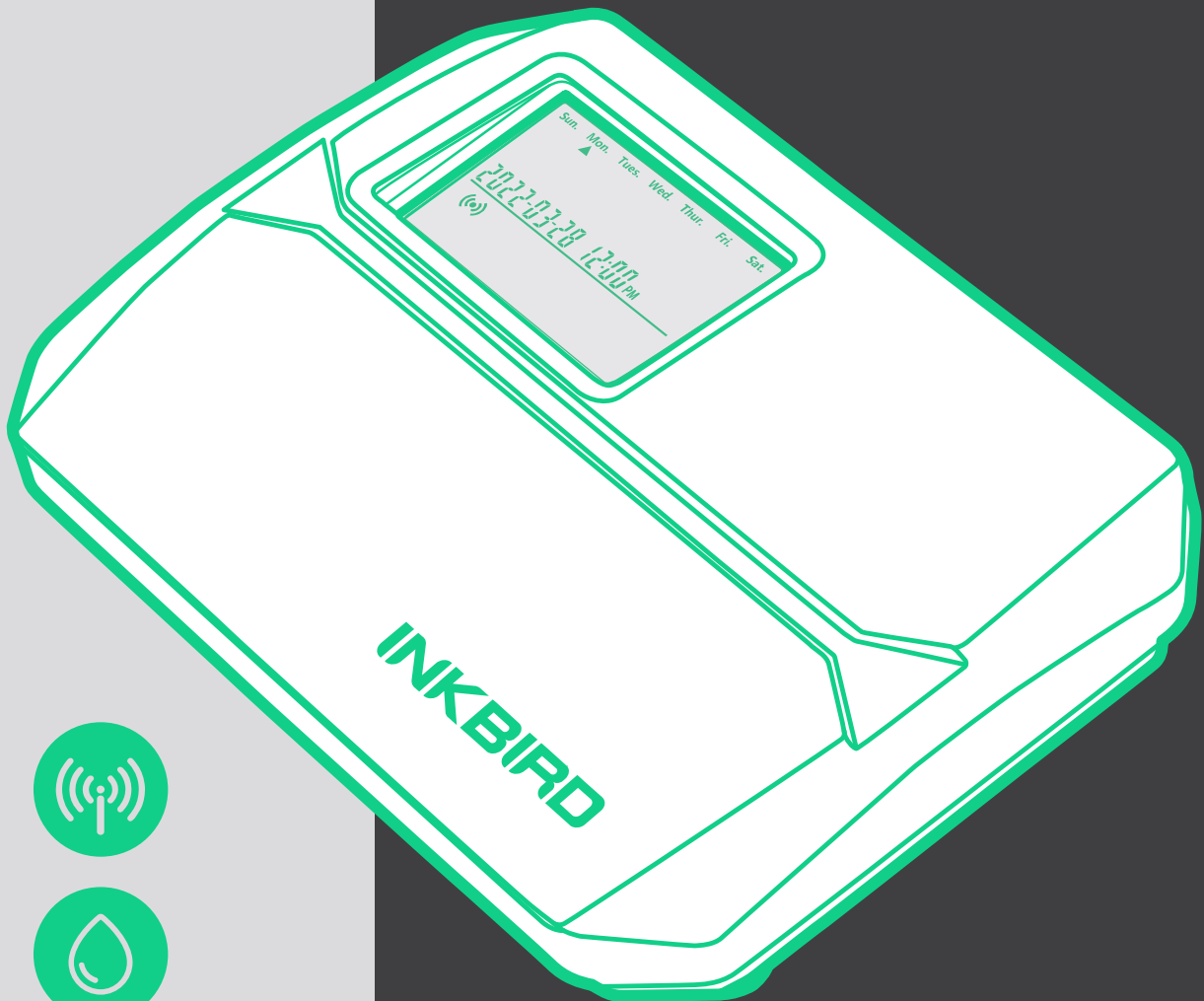

USER MANUAL

CONTENTS

01	Overview	01
02	Features & Specifications	01
03	Product Diagram	02
04	Operation Instructions	03
05	Installation	19
06	Troubleshooting Guide	25
07	Product Warranty	25
08	FCC Requirement	26
09	Irrigation Schedule Table	26



OVERVIEW

INKBIRD IIC-800-WIFI smart sprinkler controller upgrades your water pipes into an intelligent automatic system, which will save you plenty of time that you would have spent watering in the past. This controller features a Wi-Fi function, enabling you to program and monitor irrigation by your phone. It can control up to 8 zones and automatically start and stop irrigating at the specific time you programmed. There are no more dead plants because you forgot to water them, and no more soggy lawns because you forgot to turn the water off. Features multiple user-friendly functions, this smart irrigation controller is an ideal assistant to help you build a wonderful garden.









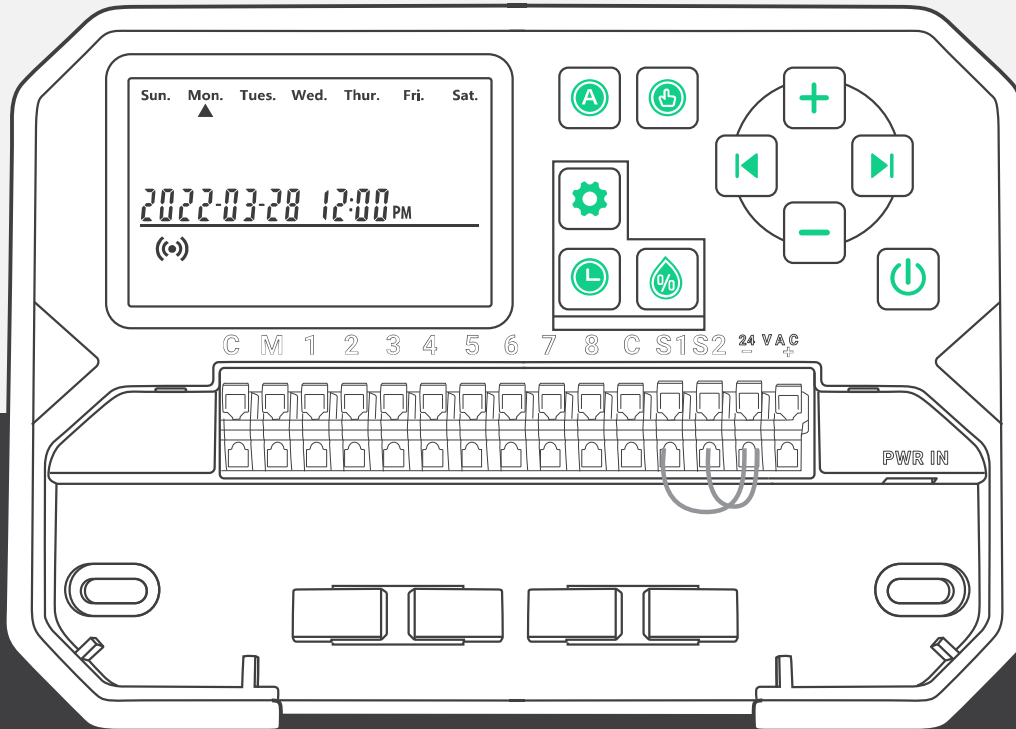

FEATURES & SPECIFICATION

- Product Name: Smart Sprinkler Controller
- Model: IIC-800-WIFI
- Power: 24VAC 1A
- LCD screen with backlight display
- For both indoors and outdoors.
- Control by phone APP in Wi-Fi connection
- Control up to 8 zones of watering.
- Station-based programming enables separate irrigation adjustments for different zones to suit the specific water needs of each zone.
- 4 cyclic options (custom days/intervals/odd days/even days) to customize irrigation schedules, enhancing flexibility on controlling.
- 6 start time to run a program several times on the same day.
- Manual irrigation mode to water an individual zone, several zones or all zones at a time.
- Built-in non-volatile memory to indefinitely save the settings even after a long time of power off.
- 2 Years of Product Warranty

INKBIRD
SMART HOME SMART LIFE

PRODUCT DIAGRAM



	POWER: Turn on to enter the auto irrigation mode; Turn off to stop all progressing irrigation and forbidden the auto mode		AUTOMATIC: Automatically water based on the programmed watering schedules
	SEASONAL ADJUST: Extend or reduce the irrigation duration (run time) of all stations		SCHEDULE: Customize irrigation schedules, to determine how often the timer will water
	MANUAL: Immediately water all zones or one or several zones		BACK: Move backward to select a programming option or choose the Wi-Fi connection mode
	DATE&TIME: Set the current date and time		NEXT: Move forward to select a programming option or choose the Wi-Fi connection mode
	Increase the numeric value (long press for quick adjustment)		Decrease the numeric value (long press for quick adjustment)

OPERATION INSTRUCTIONS

INKBIRD APP Setting



Download the APP

Search the keyword “INKBIRD” in App Store or Google Play, or scan the left QR code to download and install the APP.

Pair your phone

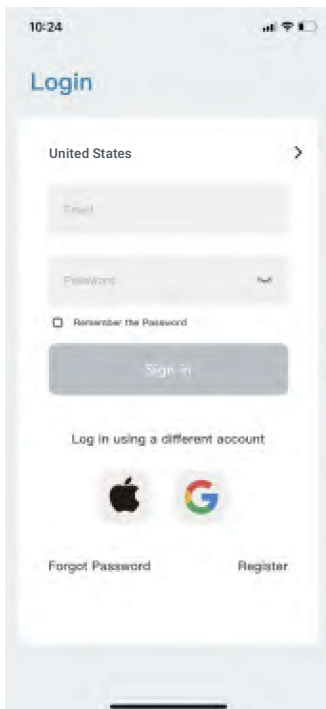

- Open the app and enter the login interface. You can log in by your Apple ID, Google ID.

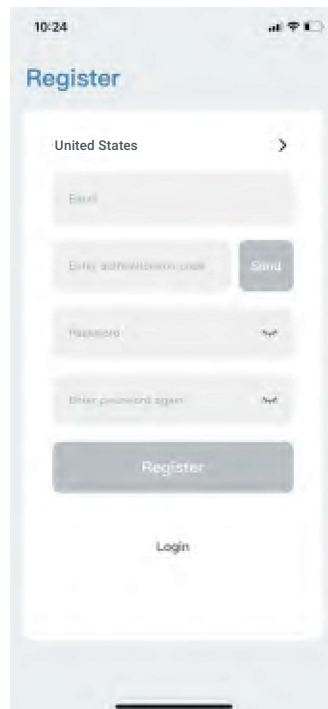

- You can also click register and use your email address as prompted to register.

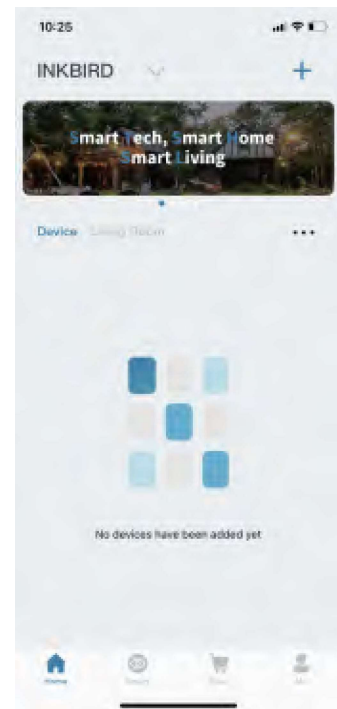

- Congratulations that you have successfully created your home.



- Now you can add the device needed. Click “+” in the top right corner to add the device.

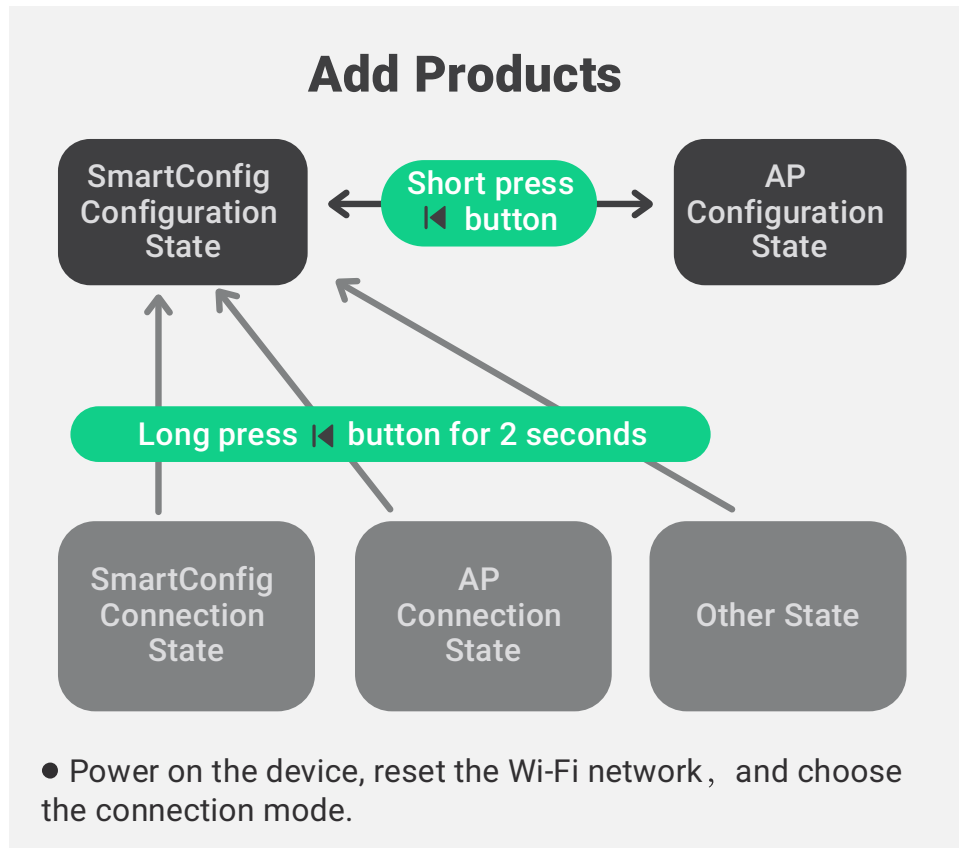

1/ Turn on the device.



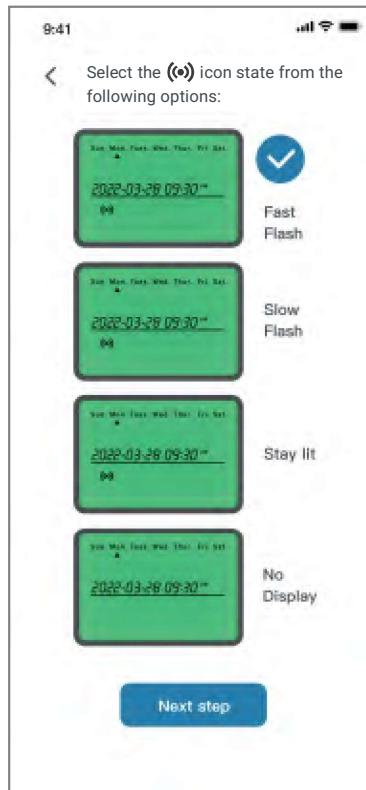
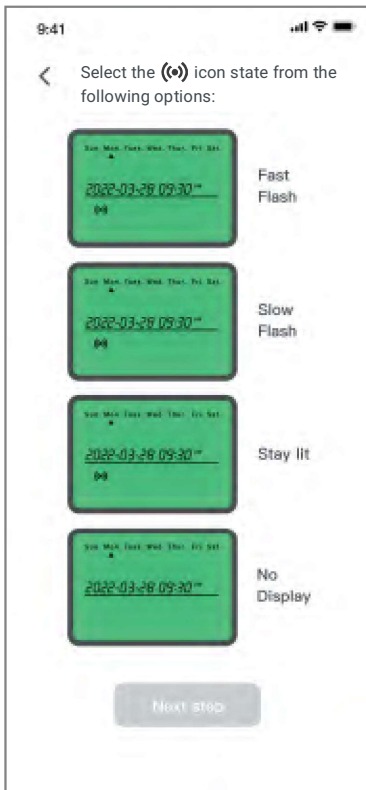

2/ Confirm and select the Wi-Fi icon status of the device, then click the relevant symbol on the app.

Note: If the Wi-Fi icon of the device is in the “Stay Lit” or “No Display” state, click the relevant symbol and follow the steps below.

- **Fast Flash:** Press and hold the button for 2 seconds to reset the Wi-Fi connection, and make sure the (📶) icon flashes quickly (wait for about 5 seconds after pressing the button before the status changes).

- **Slow Flash:** Press and hold the button for 2 seconds to reset the Wi-Fi connection. When the (📶) icon is quickly flashing, short press the button again to switch to the slow flashing state (wait for about 5 seconds after pressing the button before the status changes).

Note: To enter the fast flashing or slow flashing status, we should wait about 5 seconds after pressing the button before the status changes.

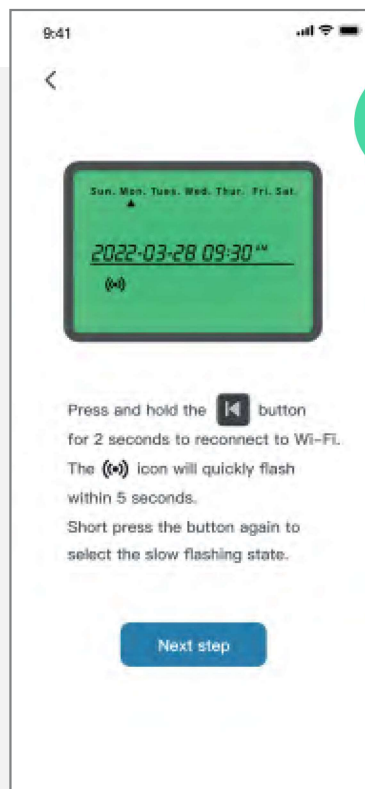

Or

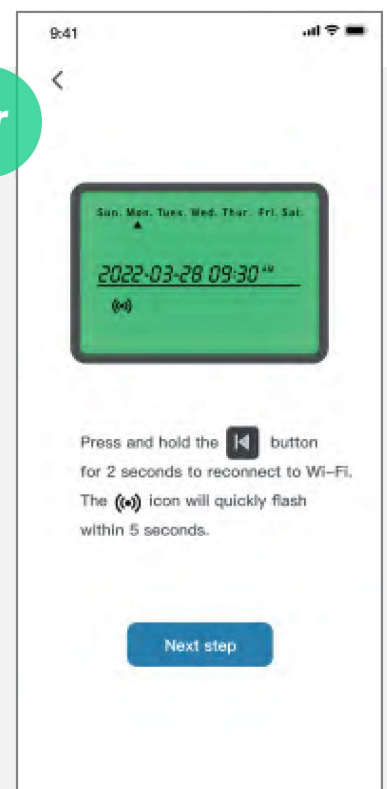

3/ SmartConfig Connection Mode (Fast Flash)



- Enter your Wi-Fi account and password.
Note: This device supports a 2.4GHz Wi-Fi network only.



- Pairing is successful.

4/ AP Connection Mode (Slow Flash)



- Choose the name of your Wi-Fi device and enter the password before clicking "Next step" to start the connection.

Note: This device supports a 2.4GHz Wi-Fi network only.

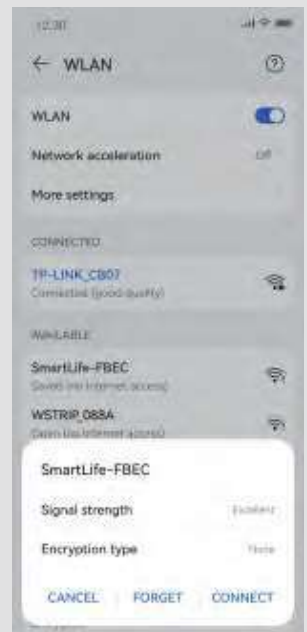
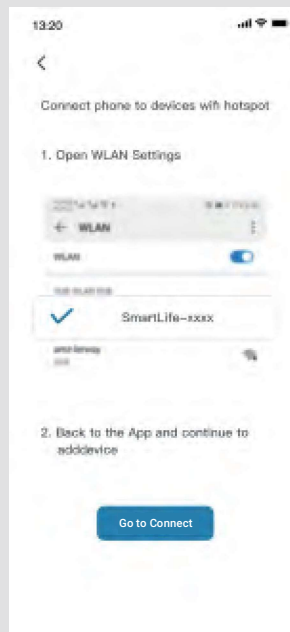

- Click "Go to Connect" to go to your phone's WLAN setting page, select the "SmartLife-xxxx" to connect to the router before returning to the connection interface.

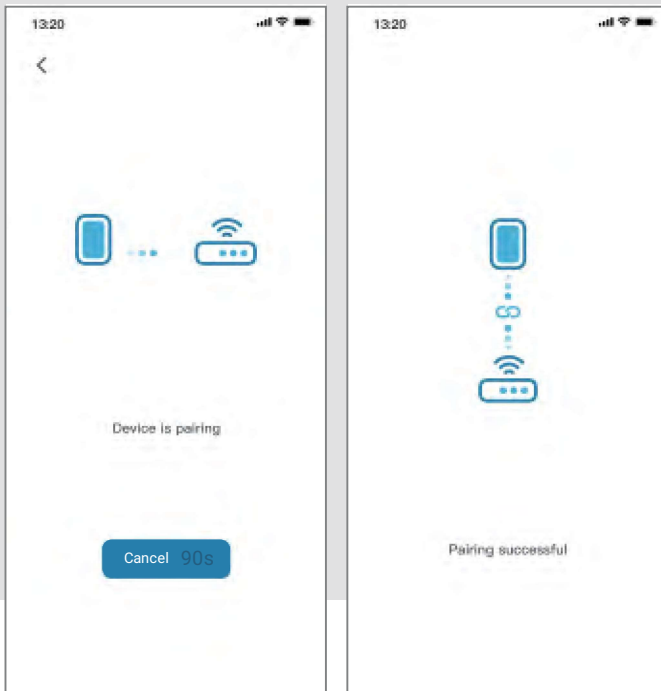

- Pairing is successful.

Functional Operation on APP Interface

Main Interface

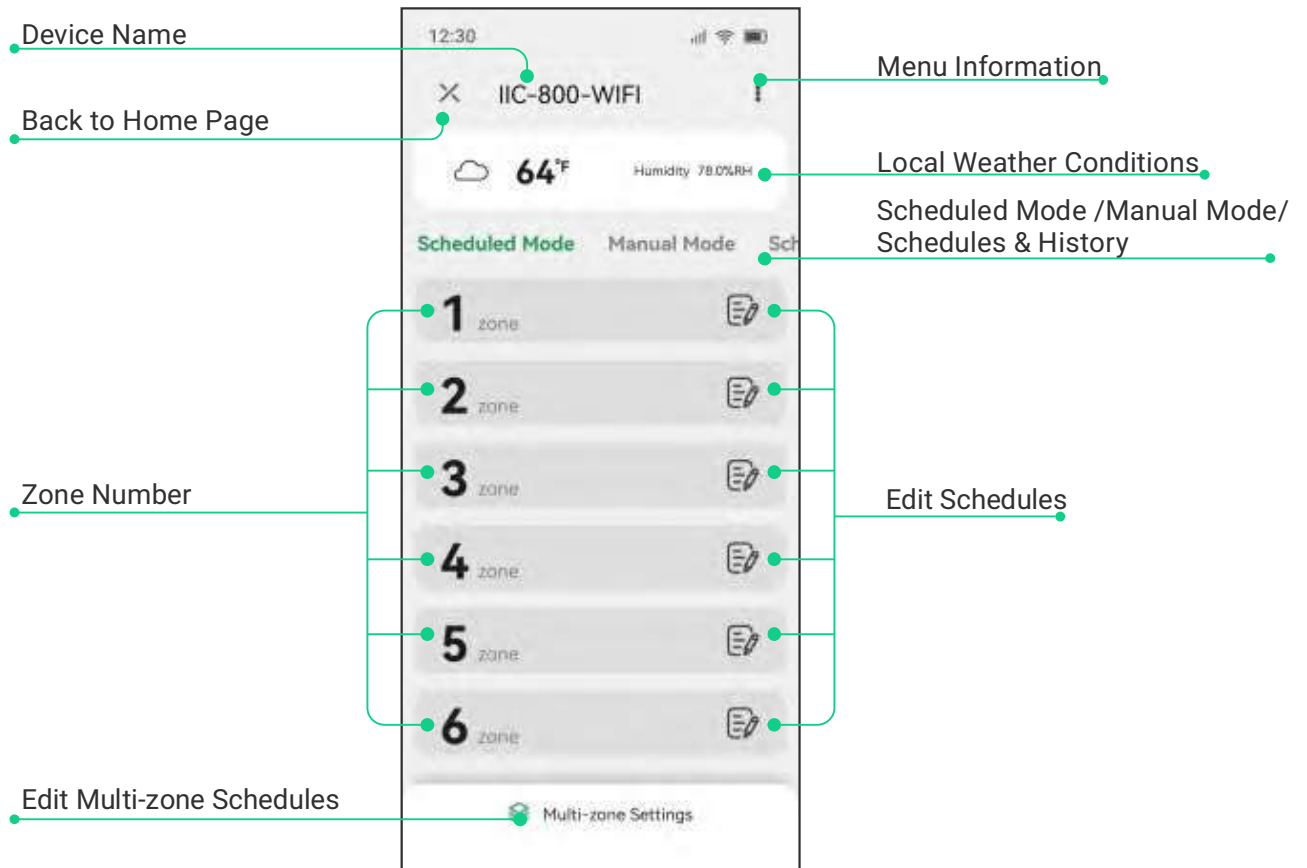

● Menu Information

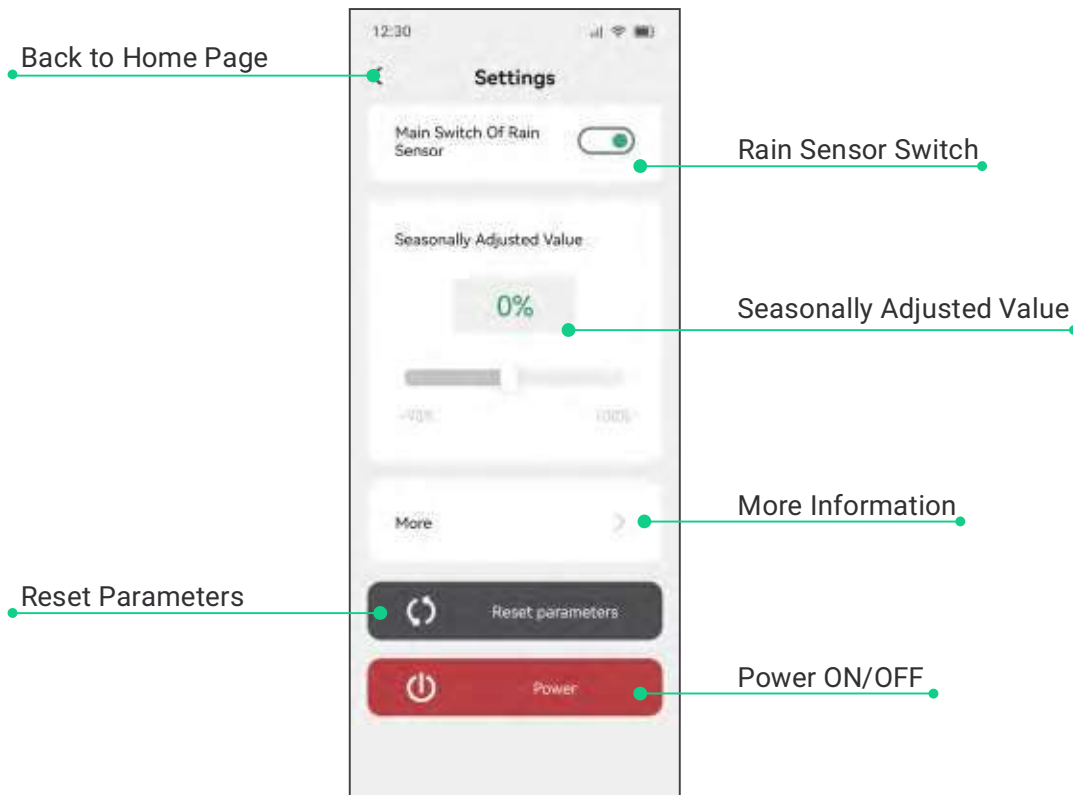

Interface of Scheduled Irrigation

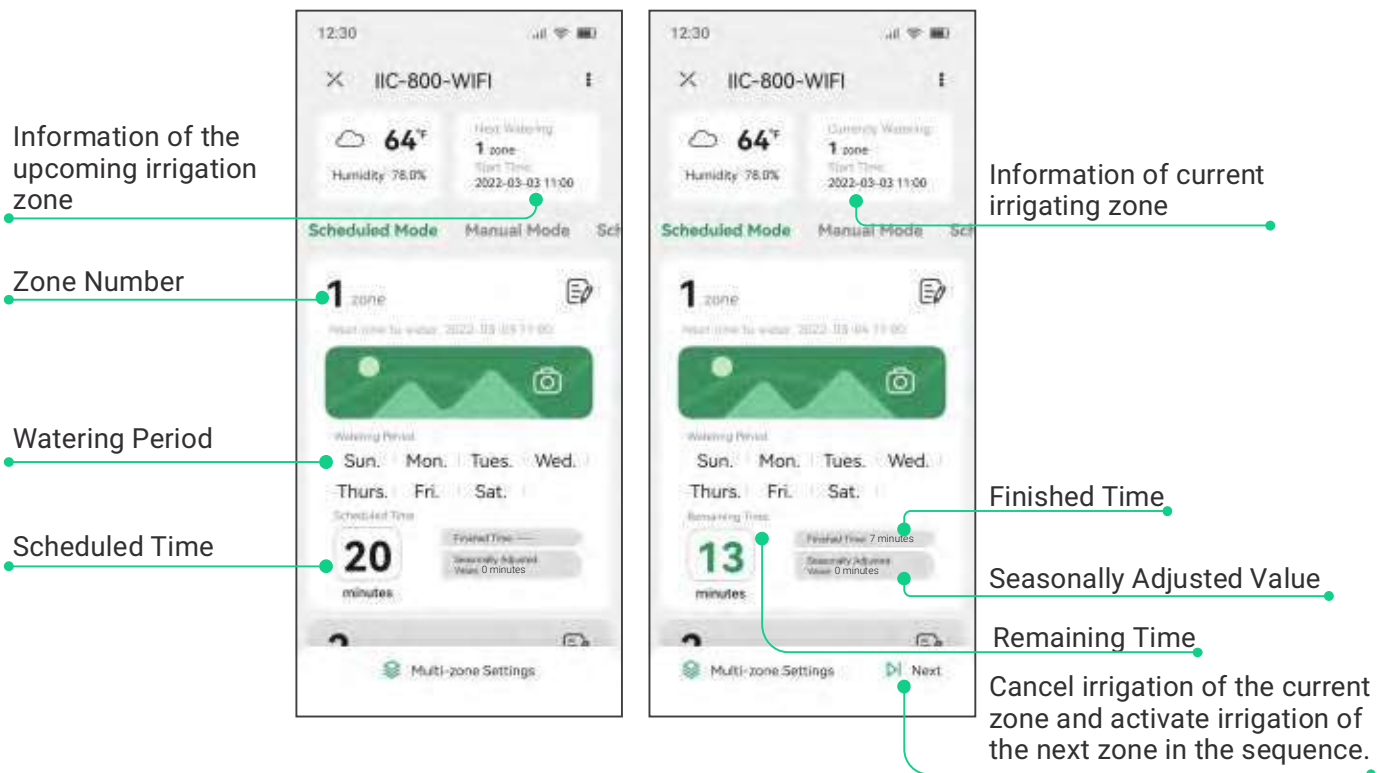

Interface of scheduled irrigation settings

Shut down the zone

Cancel the setting and restore the last setting parameters

Zone description, such as "Front yard garden"

Watering Peroid

Choose to obey or ignore the rain sensor on this zone

Scheduled irrigation time

Start Time

Shut down the zone and restore default data



Confirm the settings.

Interface of Manual Irrigation

- Interface of single or multiple zones

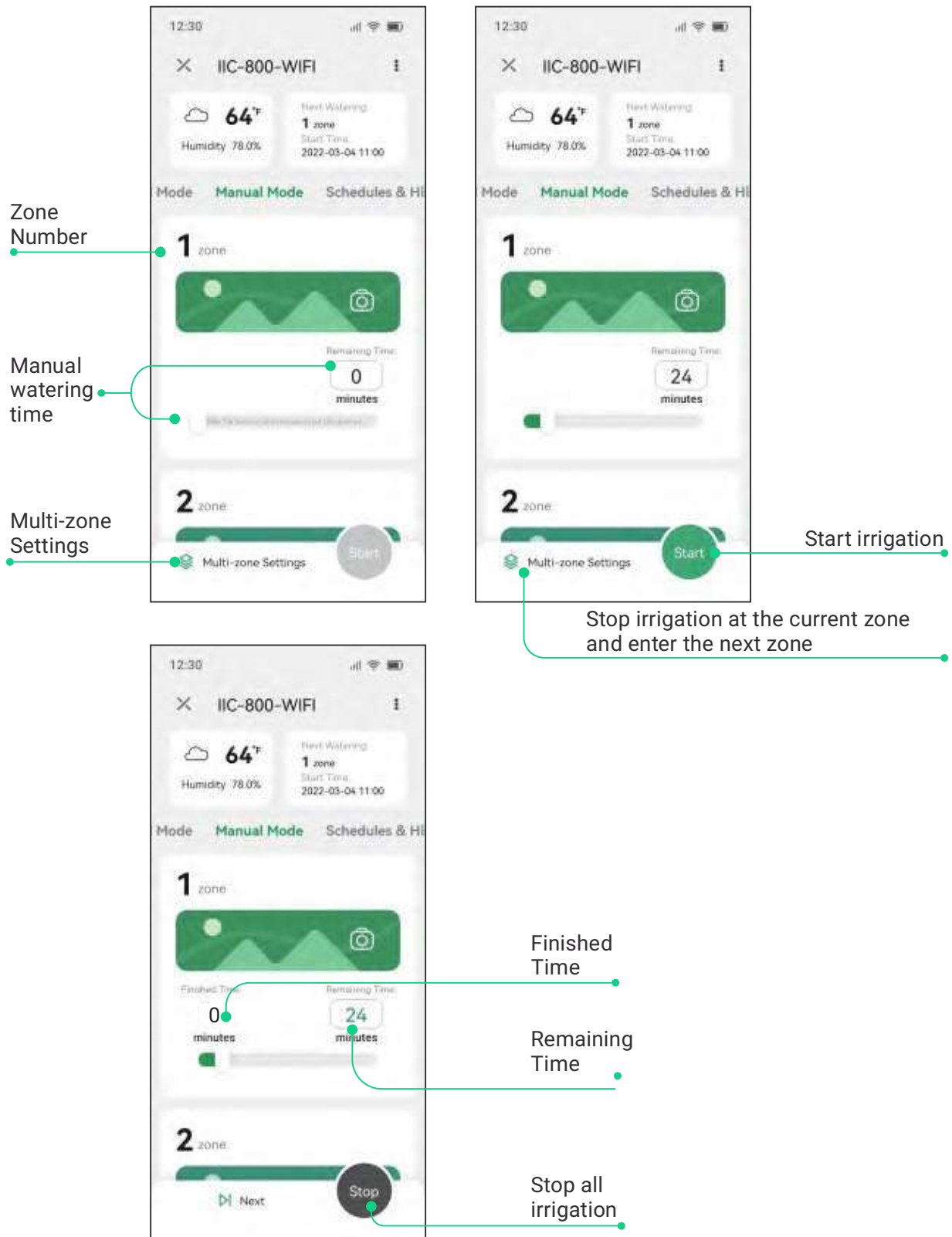

Device Settings

Date & Time: Set the clock time, year, month and day

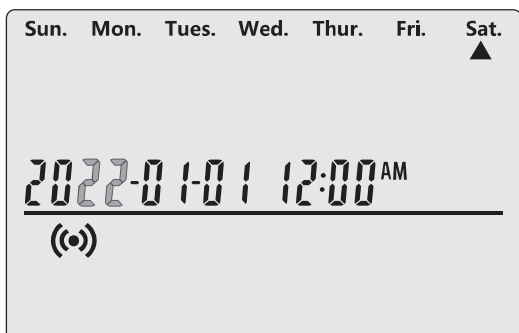

- Press the button to enter the setting of the current time; Long press the button for 2 seconds to select between 12-hour clock and 24-hour clock.
- Press the or button to select parameters. You will see the selected characters flashing.
- Press the or button to adjust the numeric value.

- Press the button to quit setting and save parameters. The device will automatically quit and save settings if there is no operation within 60 seconds.

Note: A super capacitor is built into the device to keep the date and time running in blackout without installing spare battery. It can sustain 10~15 days during blackout time under the fully charged state.

- If the device is connected to a Wi-Fi network, the local time will be automatically updated to the device.

Schedule: Customize irrigation schedules

- Press the button to enter the setting of irrigation schedules.

1/ Select a zone

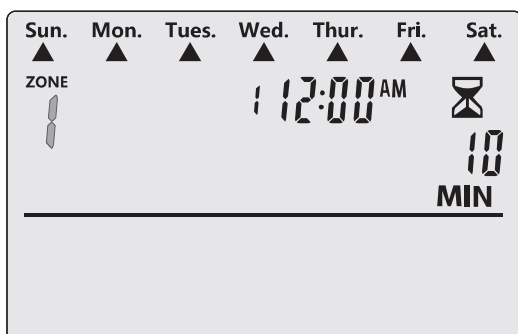

- Press the or button to select a zone, then press the button to move forward to the next option.

2/ Set watering duration

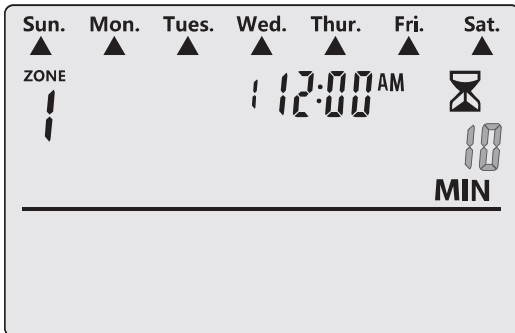

- Press the **+** or **-** button to adjust the watering duration time, then press the **▶** button to move forward to the next option.

3/ Set watering start times

Note: 1~6 start times can be set for each zone.

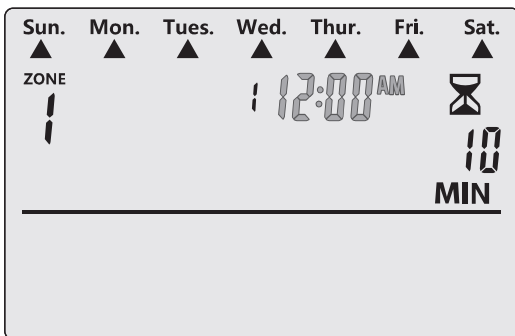

- Press the **+** or **-** button to set the first watering start time of the zone, then press the **▶** button to move forward to the next option. (The watering start time can increase or decrease progressively in a unit of 10 minutes.)
- You can repeat the above steps to set multiple start times.

Note: When the screen displays “--:--” as start time, the start time is not set, you can press the **▶** button to move forward to **Set watering start days**.

4/ Set watering start days

- There are 4 options when determining how often the timer will water – custom days, odd days, even days or an interval of few days.

Option 1: Water on custom days

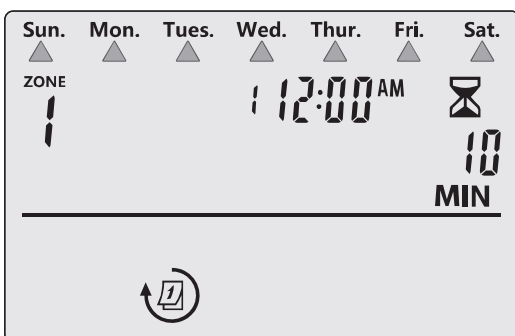

- Press the **+** or **-** button to select days of the week. You will see the display characters flashing. Press the **▶** button to move forward to the further setting.

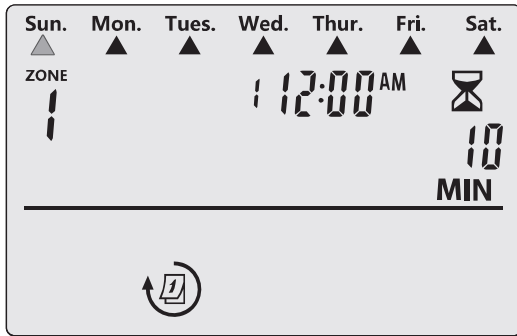

- Press the **+** or **-** button to activate or forbidden irrigation on the designated day which is flashing, then move to the setting of the next day. Or you can press the **▶** button to move to the setting of the next day.

Option 2: Water on odd days



- Press the **+** or **-** button to select the odd numbers of **1,3,5...29**. You will see the display characters flashing. In that case, press the **▶** button to move forward to the next option.

Option 3: Water on even days

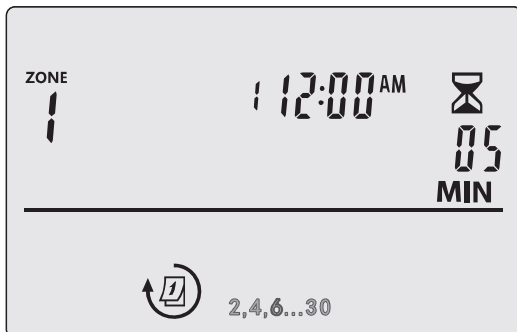

- Press the **+** or **-** button to select the even numbers of **2,4,6...30**. You will see the display characters flashing. In that case, press the **▶** button to move forward to the next option.

Option 4: Water on an interval of specific days



- Press the **+** or **-** button to select EVERY DAYS STARTING. You will see the display characters flashing. In that case, press the **▶** button to move forward to the next setting.





- Press the **+** or **-** button to set a number of days for the time interval. You will see the display character flashing. In that case, press the **▶|** button to move forward to the next setting.



- Press the **+** or **-** button to set the desired start day. You will see the display characters flashing. In that case, press the **▶|** button to move forward to the next step.

Please repeat steps 1~4 if you want to program the other 7 zones.

5/ Press the button  or  button to quit setting and reverse back to automatic mode. The device will automatically quit and go back to automatic mode, if there is no operation within 10 minutes.

6/ If you want to abandon this parametric setting, you could press the  button to exit and return to Auto mode. All parameters will be restored as the previous settings.

Auto Mode: Automatically water based on the customized schedules

Press the  button to turn on the automatic mode. You can monitor the irrigation work on the screen.

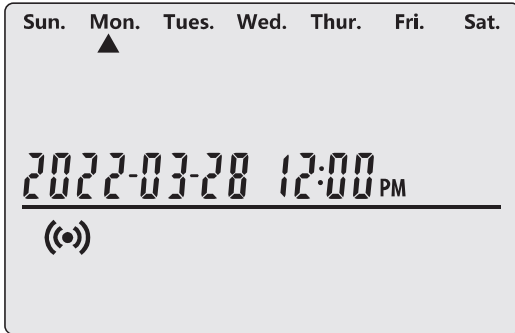

Display in Auto Mode: The screen displays the current time and date.

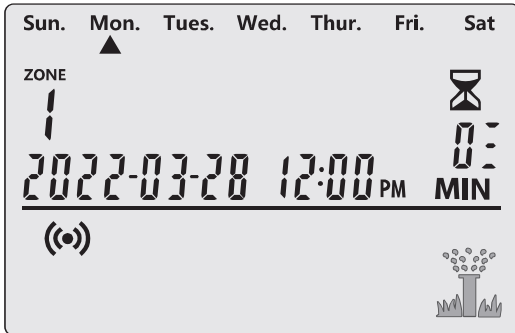

Display in Irrigation Process: The screen displays the current time and date, the serial number of the zone, and the remaining watering time. You will see the icon of the sprayer flashing.

- Press the **+** or **-** button to increase or decrease the remaining watering time.

Note: In the irrigation process, you can press the **▶|** button to immediately cancel irrigation of the current zone and activate irrigation of the next zone in the sequence.

Inquiry Function

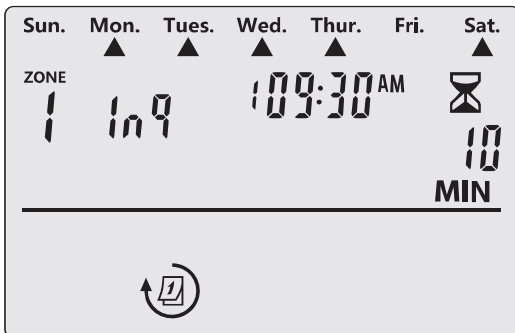

- In auto mode and simultaneously in the non-irrigation process, press the **+** or **-** button to enter the inquiry interface. You will see the characters "Inq"(inquiry) displaying and the information about the watering schedules of this zone.

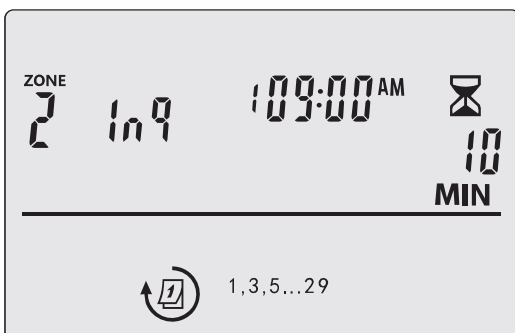

- Press the **+** button to select a zone for inquiry.

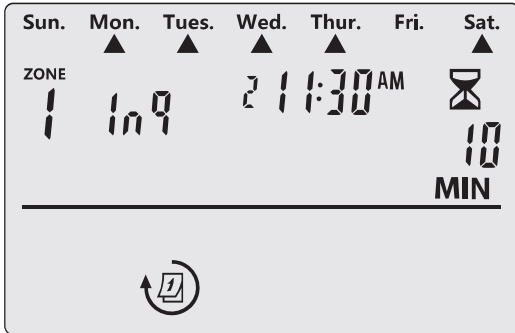

- Press the button to check other start times on this zone.
- Press any other buttons or wait for 5 seconds of no operation to quit the inquiry state.

Turn On/Off: Turn on to enter the auto mode to irrigate based on programmed schedules; turn off to immediately cancel all progressing irrigation and, also forbidden auto irrigation.

- Under startup state, press the button turn off the device and immediately cancel all progressing irrigation. The display screen will display OFF.

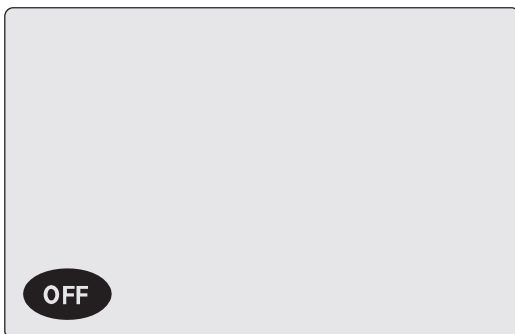

- Under shutdown state, press the button to turn it on. The device will enter the auto mode and monitor irrigation.
- **Factory Reset:** Under any state, press the button and hold for 5 seconds until you hear a beep sound to restore factory settings.

Manual Mode: Start watering immediately

Irrigate All Zones

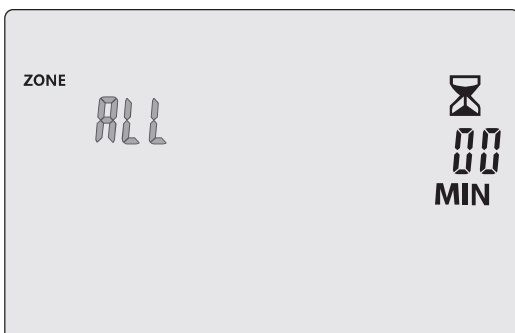

- Press the button to enter the manually irrigating mode.

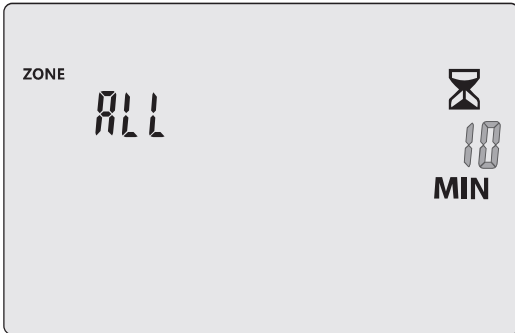

- All zones are selected by default. Press the ► button to move forward to the next option.
- Press the + or - button to set the desired watering duration time.
- Press the ⏸ button to quit setting and start irrigating. The device will automatically quit and start irrigating if there is no operation within 60 seconds.

Irrigate One or Several Zones

- Press the ⏸ button to enter the manually irrigating mode.



- Press the + or - button to select a zone, then press the ► button to move forward to the next option.

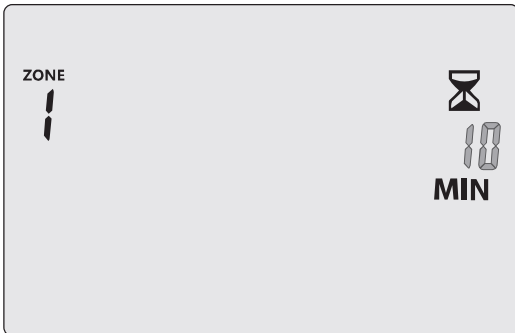



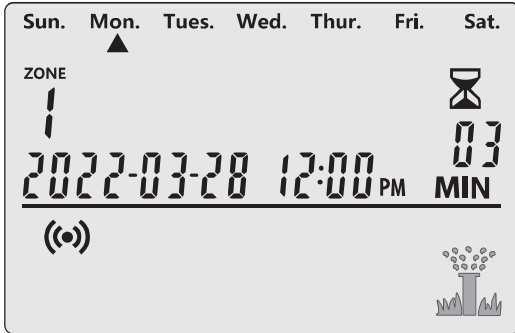

- Press the + or - button to set the desired watering duration time.
- Note: Repeat the steps above if you want to set other zones.**
- Press the ⏸ button to quit setting and start irrigating. The device will automatically quit and start irrigating if there is no operation within 60 seconds.

Display in Manual Irrigation Process: the screen displays the serial number of the current irrigation zone, the remaining time and the current date and time.





Note:

- In irrigating process, if you press the  button, all irrigation will be paused and the device will enter shutdown mode.
- You can press the  button to stop all irrigation and enter auto irrigation mode.

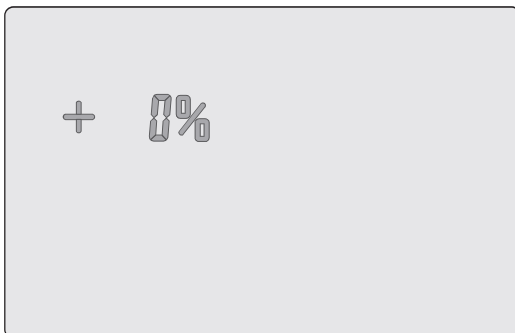

- You can press the  or  button to adjust the remaining watering time of the activated zone based on your need.
- You can press the  button to immediately cancel irrigation of the current zone and activate irrigation of the next zone in the sequence.

Seasonal Adjust: Adjust irrigation duration of all zones

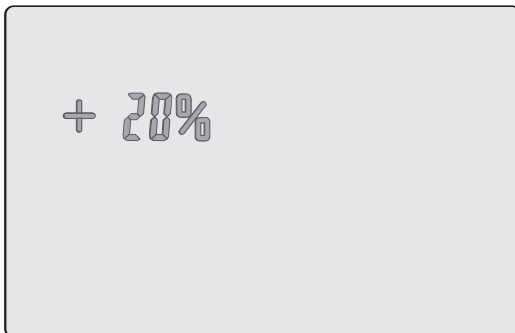

- Press the  button to enter the setting of seasonal adjust.





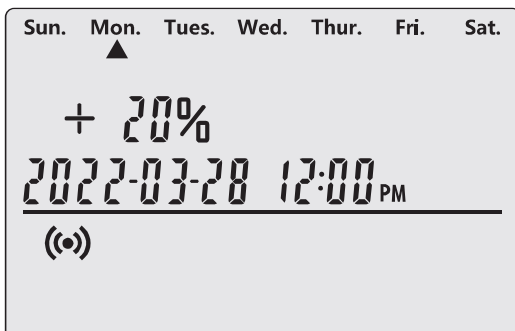

- Press the  or  button to increase or decrease the watering duration time in percentage terms.





- Press the  button to quit and save the setting. The device will automatically quit and save the setting if there is no operation within 60 seconds.

Rain Sensor Bypass: Set controller to OBEY or IGNORE the Rain Sensor

a) Set Bypass for one or several zones

- Press the  button to enter the setting.
- Press the  or  button to select the desired zone number.
- Press the  button for 2 seconds to toggle between OBEY and IGNORE.
- A symbol of  is displayed when IGNORE is selected.

b) Main switch of rain sensor

- In auto mode, press the  button for 2 seconds to toggle between OBEY and IGNORE the rain sensor.
- A symbol of  is displayed when IGNORE is selected.

Note:

If you choose IGNORE on the main switch of the rain sensor, one or several zones will ignore the rain sensor function while irrigating, regardless of the rain sensor setting on them.

INSTALLATION

Controller Installation

- Choose a proper place for installation where you can connect the device to an external power source. Please make sure the distance between the device and the power socket is under 6 feet (1.8 meters). Meanwhile, you should leave proper heights and space to install conduits of the device.

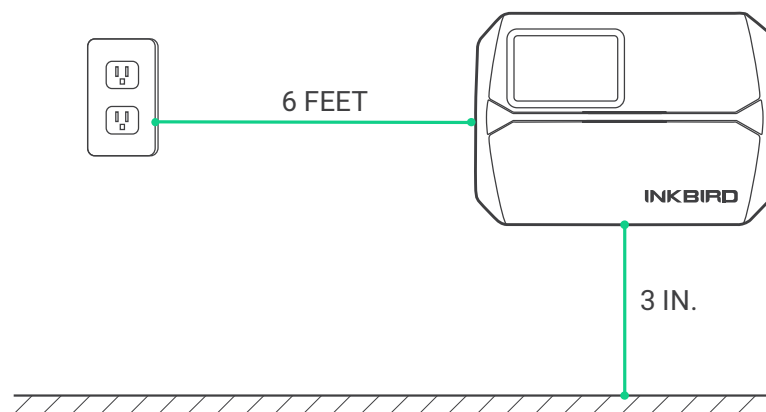

- Insert the screws into the wall. There should be a gap about 3 mm width between the screw head and the wall.

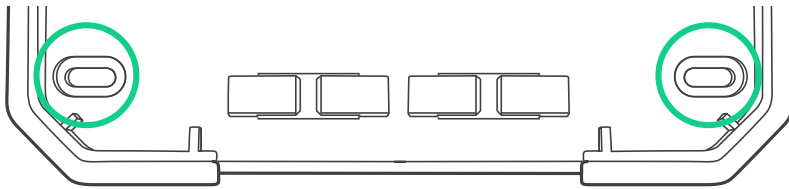
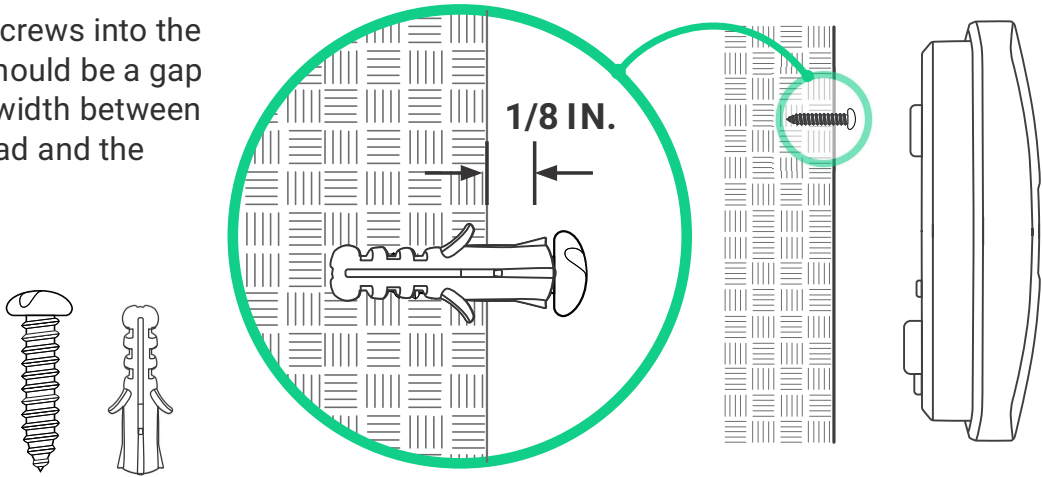

- You can tighten up both holes on the bottom using screws just in case, though it would be uneasy to disassemble them afterward.

Wiring Connection

a) Connect zone valves

- Connect the power supply of each zone valve to the terminal of the controller, corresponding to the station number.
- Connect the common line of each valve to the common port C.

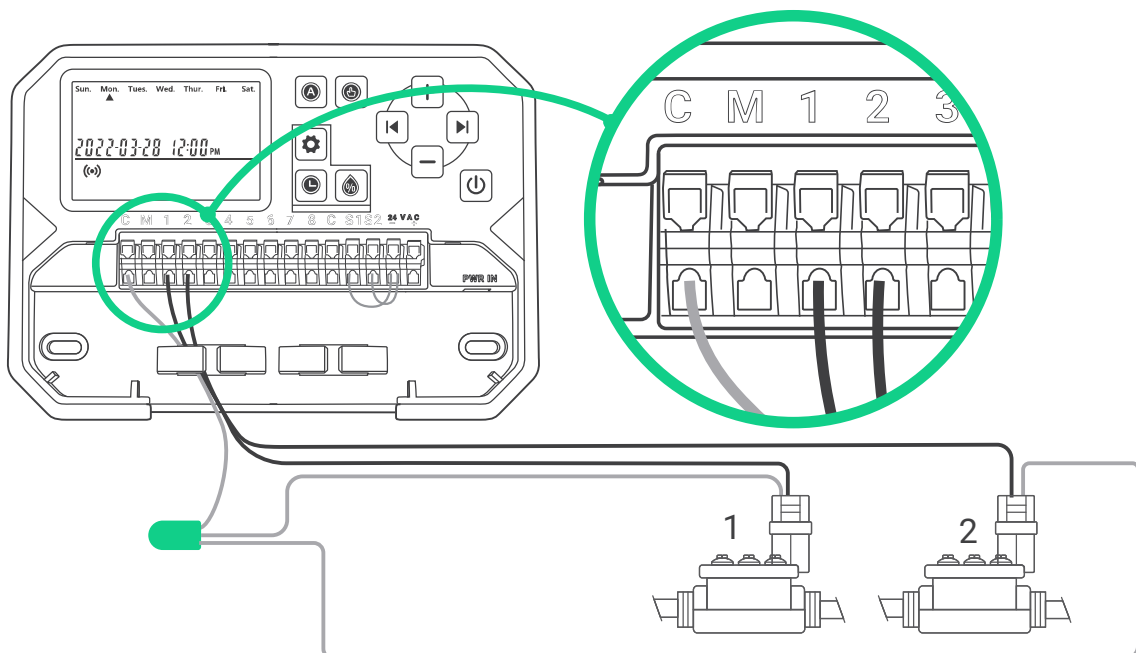

b) Connect master valve (optional)

Optionally connect the master valve or the pump to the controller.

- Connect the power supply of the master valve or the pump to port M on the terminal of the controller.
- Connect the common line of the master valve or the pump to the common port C.

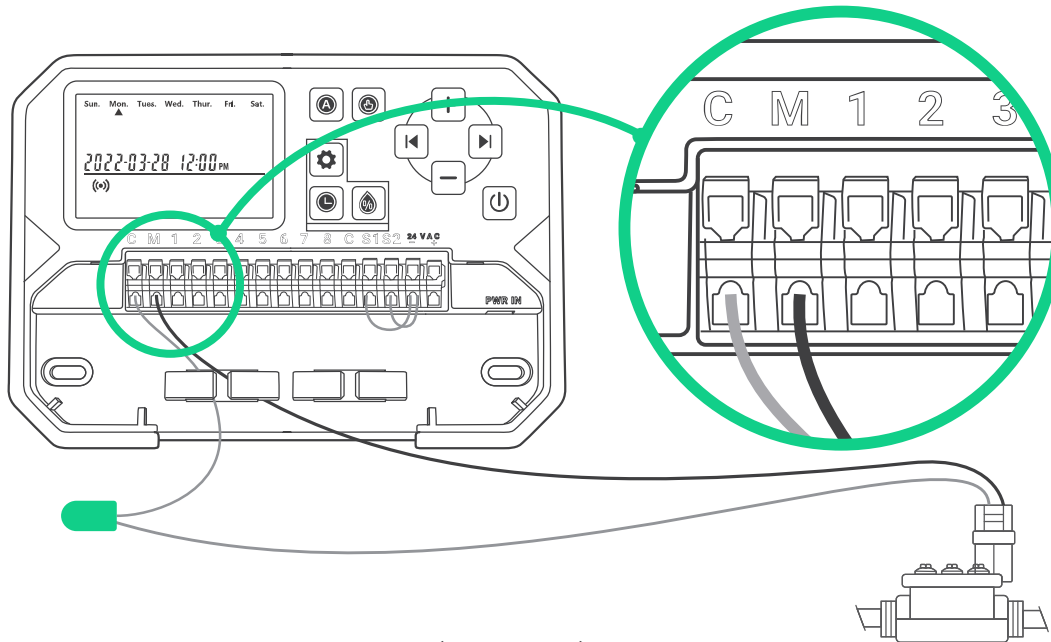

c) Connect Pump Start Relay(optional)

Connect a selectable pump start relay to the IIC-800-WIFI controller.

Water pumps are used to extract water from wells or other water sources. If you want to start up the water pump of the controller, you must install a pump start relay.

The connection of the pump start relay and the controller is the same as the main valve does, but the connection of the water source is different.

Note: The IIC-800-WIFI controller does not provide the main power supply for the water pump.

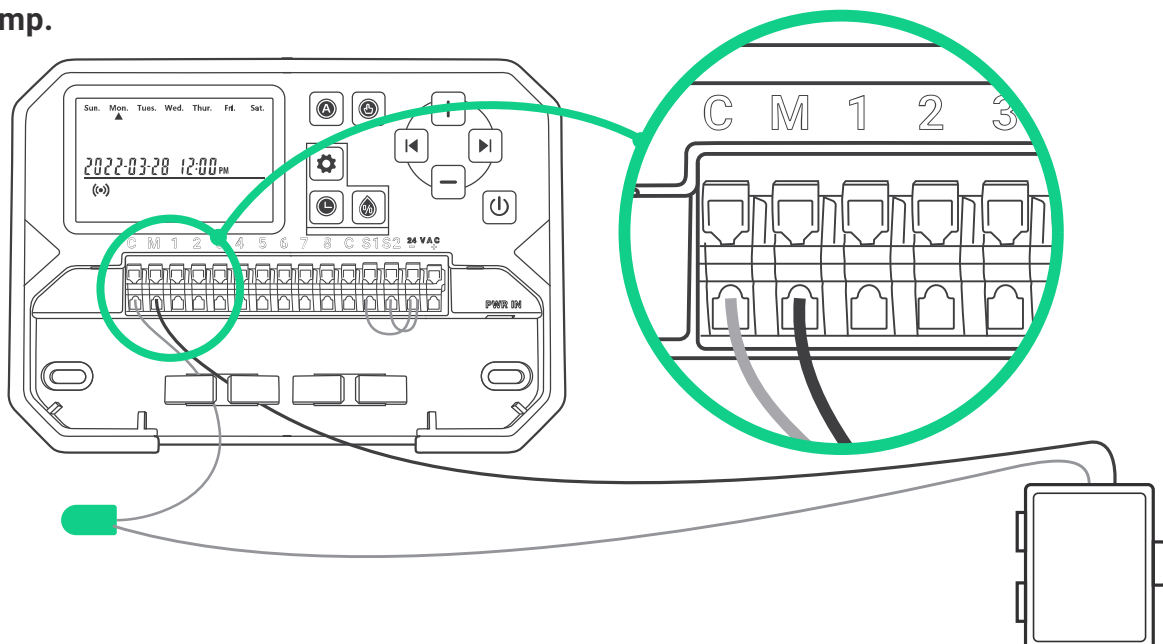

d) Connect rain sensors (optional)

- Remove the jumpers on ports 24 VAC- and S1 (or S2) of the terminal.

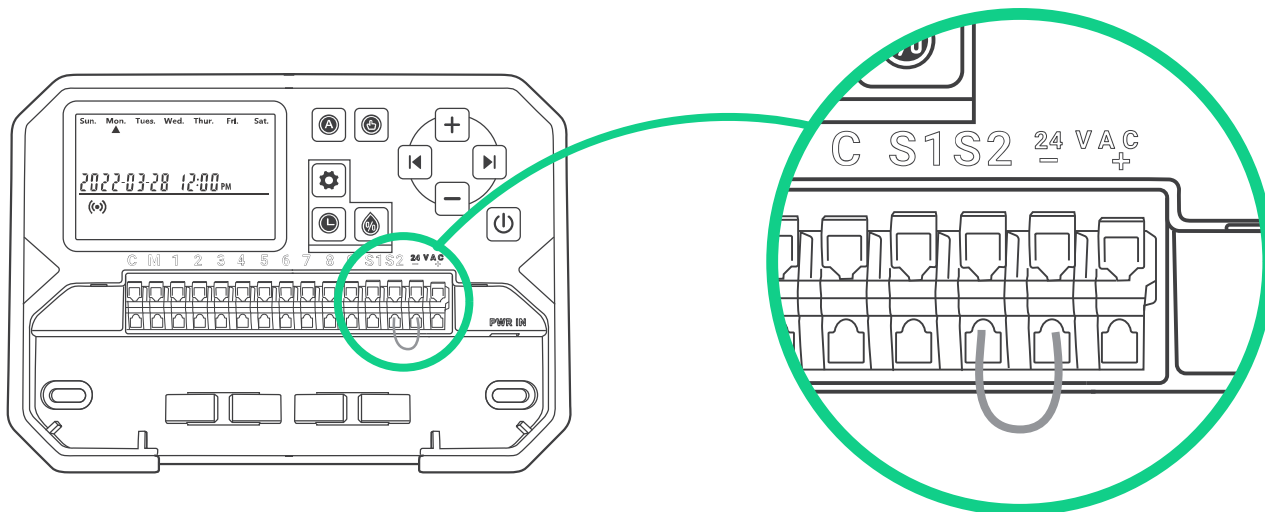

- Separately connect the 2 lines of the rain sensor to ports 24 VAC- and S1 (or S2).

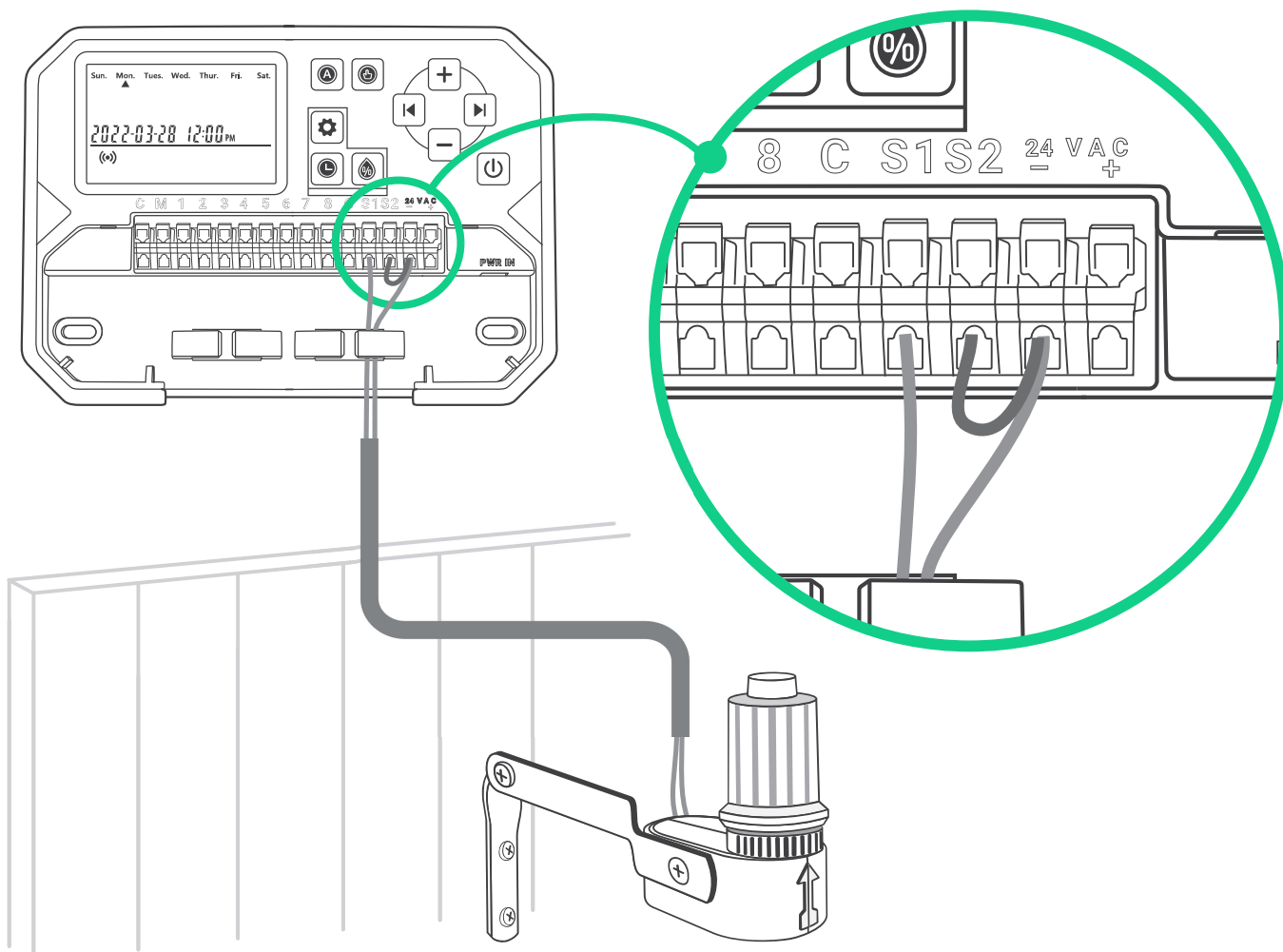

Note:

- The 24 VAC- port is a common port.
- You must connect the S1 port and S2 port with the 24 VAC- port if there is no rain sensor connected.

Power Supply Connection

- This controller adopts adapters following local safety regulations' certification, convenient and safe.
- Insert the power output end into the PWR IN jack of the device.

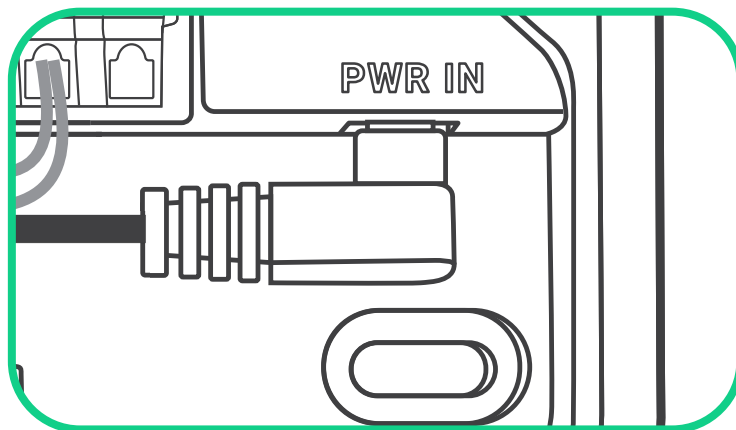

- Put power lines into the line slots of the device.

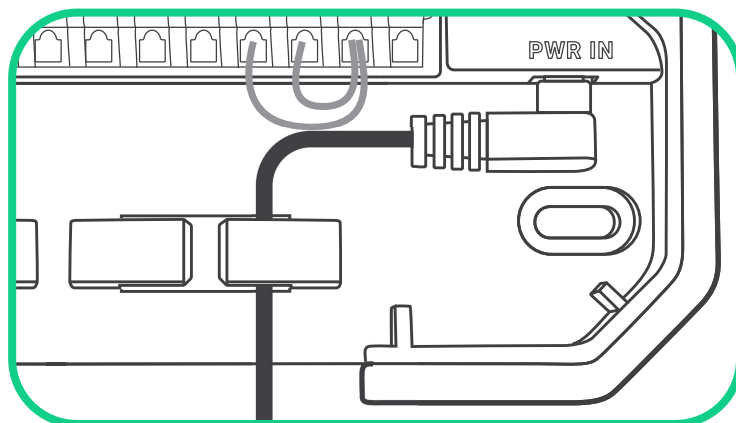

Note:

PLEASE DO NOT turn on the power before confirming all lines are well-connected.

- Please cut off the power of the line if it's damaged. In that case, we suggest changing a replacement line to avoid potential harm.

Wiring

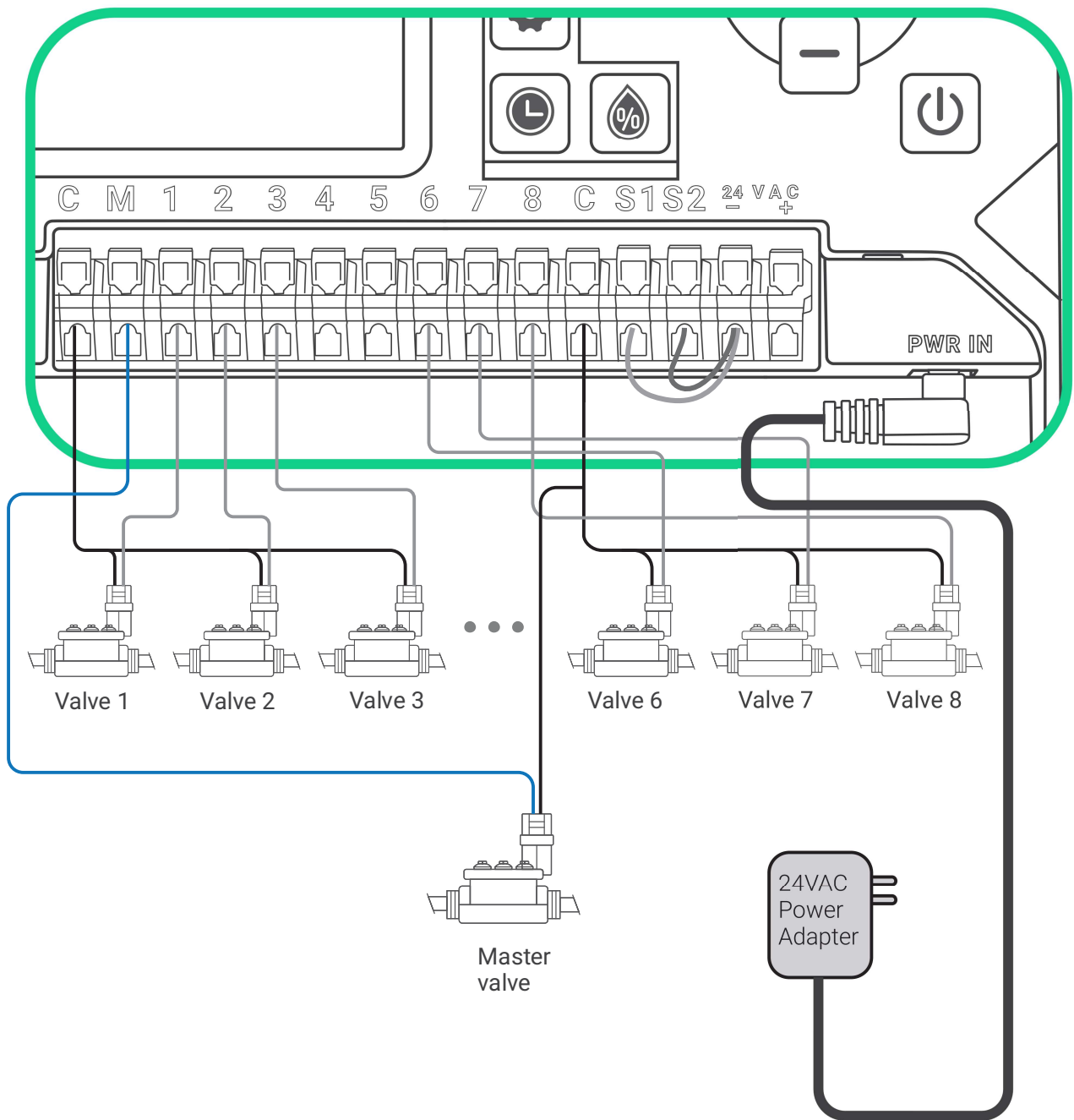

TROUBLESHOOTING GUIDE

What can you do if the programmed system or the manual mode is not working? Here are some possible reasons and relative solutions for reference. We hope they are helpful. For any further questions, please feel free to contact INKBIRD.

TROUBLESHOOTING GUIDE

Q: The water supply is not available?

A: Please confirm if the water main is connected and if all water pipes are open and work normally.

Q: Lines are loose or incorrectly connected?

A: Please confirm if the ground line and the main valve, or the triac, are steadily connected to the controller, and firmly linked on the scene.

Q: Electrical wires on the scene are corroded or damaged?

A: Please install a replacement wire if the original one is damaged. You can install a waterproof connector if needed.

Q: The rain sensor in connection being activated?

A: Please dry out the rain sensor or disconnect it to the terminal of the controller, and then connect 2 SENS ports using the jumper.

Q: The jumper on the terminal that linked 2 SENS ports is missing or damaged?

A: Link 2 SENS ports on the terminal of the controller with a jumper, which is 3 to 4 mm thick.

Q: When the device displays "Time Error" and keeps alarming, and the app shows that "The clock is abnormal, please check it in time", does the device still work normally?

A: Please disconnect the power and then reconnect. If the problem is still not resolved, please contact us.

PRODUCT WARRANTY

This item carries a 2-year warranty against defects in either components or workmanship. During this period, products that prove to be defective will, at the discretion of INKBIRD, be either repaired or replaced without charge.

FCC REQUIREMENT

Changes or modifications not expressly approved by the party responsible for compliance could void the user's authority to operate the equipment. This device complies with Part 15 of the FCC Rules. Operation is subject to the following two conditions:

- (1) this device may not cause harmful interference, and
- (2) this device must accept any interference received, including interference that may cause undesired operation.

Note: This equipment has been tested and found to comply with the limits for a Class B digital device, pursuant to Part 15 of the FCC Rules. These limits are designed to provide reasonable protection against harmful interference in a residential installation. This equipment generates, uses, and can radiate radio frequency energy, and if not installed and used in accordance with the instructions, may cause harmful interference to radio communications. However, there is no guarantee that interference will not occur in a particular installation. If this equipment does cause harmful interference to radio or television reception, which can be determined by turning the equipment off and on, the user is encouraged to try to correct the interference by one or more of the following measures:

- Reorient or relocate the receiving antenna.
- Increase the separation between the equipment and receiver.
- Connect the equipment into an outlet on a circuit different from that to which the receiver is connected.
- Consult the dealer or an experienced radio/TV technician for help. This equipment complies with FCC radiation exposure limits set forth for an uncontrolled environment. This equipment should be installed and operated with a minimum distance of 20cm between the radiator & your body. This transmitter must not be co-located or operating in conjunction with any other antenna or transmitter.

IRRIGATION SCHEDULE TABLE

Before programming the controller, we suggest using this irrigation schedule table to arrange watering work at each zone and keep it as a reference.

- Name each zone one by one on the second column, such as the lawn on the front yard, left side of the courtyard.
- Determine the irrigation duration time of each zone on the third column.
- Customize the watering start time of each zone on the fourth column (total 6 start times programmable for each zone).
- Select the cyclic days of irrigation on the fifth column by marking on the checkbox. If you choose intervals, please enter the number from 1 to 9.

ZONE	DEFINITION	WATERING DURATION TIME	WATERING START TIMES		WATERING CYCLIC DAYS
1		min	1 : am/pm	2 : am/pm	<input type="checkbox"/> Days of the week: Mon. Tue. Wed. Thur. Fri. Sat. Sun.
			3 : am/pm	4 : am/pm	<input type="checkbox"/> odd days <input type="checkbox"/> even days
			5 : am/pm	6 : am/pm	<input type="checkbox"/> every ___ days
2		min	1 : am/pm	2 : am/pm	<input type="checkbox"/> Days of the week: Mon. Tue. Wed. Thur. Fri. Sat. Sun.
			3 : am/pm	4 : am/pm	<input type="checkbox"/> odd days <input type="checkbox"/> even days
			5 : am/pm	6 : am/pm	<input type="checkbox"/> every ___ days
3		min	1 : am/pm	2 : am/pm	<input type="checkbox"/> Days of the week: Mon. Tue. Wed. Thur. Fri. Sat. Sun.
			3 : am/pm	4 : am/pm	<input type="checkbox"/> odd days <input type="checkbox"/> even days
			5 : am/pm	6 : am/pm	<input type="checkbox"/> every ___ days
4		min	1 : am/pm	2 : am/pm	<input type="checkbox"/> Days of the week: Mon. Tue. Wed. Thur. Fri. Sat. Sun.
			3 : am/pm	4 : am/pm	<input type="checkbox"/> odd days <input type="checkbox"/> even days
			5 : am/pm	6 : am/pm	<input type="checkbox"/> every ___ days
5		min	1 : am/pm	2 : am/pm	<input type="checkbox"/> Days of the week: Mon. Tue. Wed. Thur. Fri. Sat. Sun.
			3 : am/pm	4 : am/pm	<input type="checkbox"/> odd days <input type="checkbox"/> even days
			5 : am/pm	6 : am/pm	<input type="checkbox"/> every ___ days
6		min	1 : am/pm	2 : am/pm	<input type="checkbox"/> Days of the week: Mon. Tue. Wed. Thur. Fri. Sat. Sun.
			3 : am/pm	4 : am/pm	<input type="checkbox"/> odd days <input type="checkbox"/> even days
			5 : am/pm	6 : am/pm	<input type="checkbox"/> every ___ days
7		min	1 : am/pm	2 : am/pm	<input type="checkbox"/> Days of the week: Mon. Tue. Wed. Thur. Fri. Sat. Sun.
			3 : am/pm	4 : am/pm	<input type="checkbox"/> odd days <input type="checkbox"/> even days
			5 : am/pm	6 : am/pm	<input type="checkbox"/> every ___ days
8		min	1 : am/pm	2 : am/pm	<input type="checkbox"/> Days of the week: Mon. Tue. Wed. Thur. Fri. Sat. Sun.
			3 : am/pm	4 : am/pm	<input type="checkbox"/> odd days <input type="checkbox"/> even days
			5 : am/pm	6 : am/pm	<input type="checkbox"/> every ___ days