

BÖLLHOFF

HELICOIL® Plus thread technology

Intelligent system solution comprising a fastener and efficient processing for high-strength screw joints



Strength and precision at their best.

You need a high-strength screw joint?
You need to reinforce or repair threads?

Your solution:

The HELICOIL® thread technology

1954

HELICOIL® Classic

Free Running and Screwlock



1998

HELICOIL® Plus

Free Running and Screwlock



For 70 years, HELICOIL® thread inserts have proven their value in practical applications. They are available in the Free Running and Screwlock versions.

Moreover you benefit from our innovative system approach with every single HELICOIL®. With the HELICOIL® thread technology, users all over the world therefore obtain intelligent system solutions comprising a fastener and efficient processing for numbers of pieces ranging from “1 to 1 million”.

There is a solution to almost every task related to this coil thread technology.

2010

HELICOIL® Tangfree

Free Running and Screwlock



2019

HELICOIL® Smart

Free Running





70 YEARS
HELICOIL®
made by **BÖLLHOFF**



Product spotlight 2

System modules — the fastener 6

 Technology 6

 Advantages in detail 8

 Variants 12

 Modular system 14

 Product combinations 15

 Scope of application 16

 Installation process 18

 Materials 20

 Design guidelines 21

 Technical data and order numbers 24

System modules — the tool 32

Installation process 46

System modules — automated processing 68

Innovative industries need innovative partners 76

Product news — HELICOIL® Cast 78

InfoPoint 80



Our InfoPoint provides additional information in the form of further brochures and/or videos at the end of this brochure.



Can you imagine a world without screws? Still today, the screw is the most widely used fastening element for detachable joints. Especially in modern lightweight construction optimised tightening methods and high-strength screws allow for continuous improvement. Considerably higher forces can be transmitted so that the size or total number of needed screws can be reduced. However, only high-strength nut threads permit to achieve high-strength screw joints. Our HELICOIL® thread technology is just the right choice here.

Your advantages — an overview

- High thread loading
- Increase in quality and value
- Wear resistance, low and constant thread friction
- High strength
- Corrosion and temperature resistance
- Cost saving
- Tight fit
- Screw loss protection — the Screwlock® variant
- Part of the circular economy*

Structural component — thread reinforcement and repair

HELICOIL® is thread reinforcement and repair. Thread reinforcement whenever low-strength materials (e.g. aluminium, aluminium-magnesium alloys and fibre-reinforced plastics) are used. Nut threads are not even worn out in the event of frequent use. For the development of series parts, HELICOIL® allows for miniaturisation and lightweight construction. The HELICOIL® thread insert has been tried and tested for more than 70 years and has become a renowned structural component.

For thread repair, they are internationally approved for the economical and permanent repair of damaged or worn out threads.

Besides the repair of valuable individual components, parts used in large-scale production which have been rejected due to faults during thread production can be reintegrated into the production process.

*"The circular economy is a model of production and consumption, which involves sharing, leasing, reusing, repairing, refurbishing and recycling existing materials and products for as long as possible. This way, the life cycle of products is extended."

Source: www.europarl.europa.eu/ (...) 07/10/2019

HELICOIL® technology



The HELICOIL® thread insert, which is made from a wire with rhombic profile, is formed into an elastic spiral. The Free Running version has a completely free running coarse thread throughout all threads. The result is a true-to-gauge internal thread. The thread insert produces high-strength threads transferring forces from flank to flank into the holding thread. The special thread start allows to position it like a screw and screw it in. To screw in the thread insert, only the respective installation mandrel of a similar size as a tap is required.



All stages of the HELICOIL® evolution are highly reliable; German as well as international industrial property rights have been filed.



Defective thread



Thread repair and reinforcement with HELICOIL® Plus

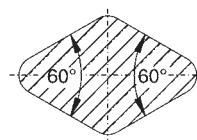

Wire cross section

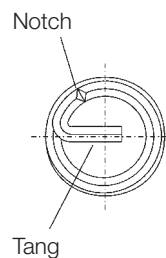
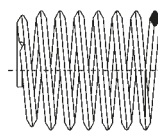

- R_m = min. tensile strength 1,400 N/mm² (1 N/mm² equals 1 MPa)
- HV = Vickers hardness 425 HV 0.2 min.
- R_z = roughness depth approx. 2.5 μ m
- μ_G = reduced thread friction, results in increased preload-force F_V at a constant tightening torque
- τ_t = reduced torsion stress in the screw shank

HELICOIL® thread inserts — advantages in detail

Wear resistance

HELICOIL® thread inserts are made of austenitic chrome-nickel steel (minimum tensile strength 1,400 N/mm²).

The high surface quality of the rolled nut thread ensures a high-strength, wear-resistant thread with an extremely small and constant thread friction torque.

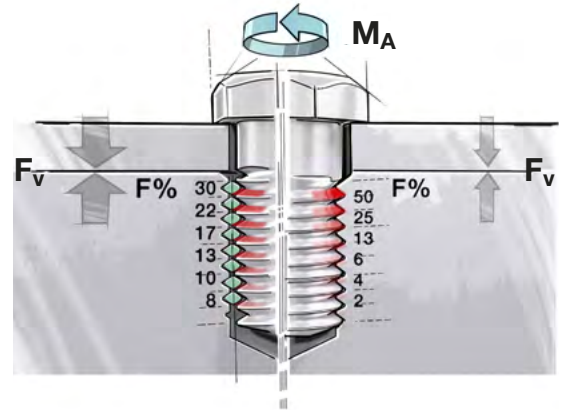

Therefore, a higher and constant preload-force is achieved for reuse at an equal tightening torque. At the same time, the utilisation of the yield point of high-strength screws is improved, while the torsion stress is considerably reduced. Compared to tapped threads, the surface roughness of the HELICOIL® is 90% smaller.

Strength

The elastic properties of the HELICOIL® thread insert allow a uniform load and stress distribution. The flank contact is optimal. Deficient pitches or angles are compensated over the entire length of the thread insert. The force transmission from bolt to nut thread is ideal. The quality of the screw joint is considerably increased — for static as well as dynamic operating loads.

The improved distribution of the preload-force increases the fatigue strength of screws under dynamic load. That is why the HELICOIL® is also suited for high-strength holding thread materials such as steel or cast iron alloys.

Corrosion and temperature resistance

The standard material of the HELICOIL® prevents the seizing of screws under environmental impact. For thermally highly stressed screw joints, there are HELICOIL® thread inserts made of nickel basis materials.

The elasticity and spring force are conserved.

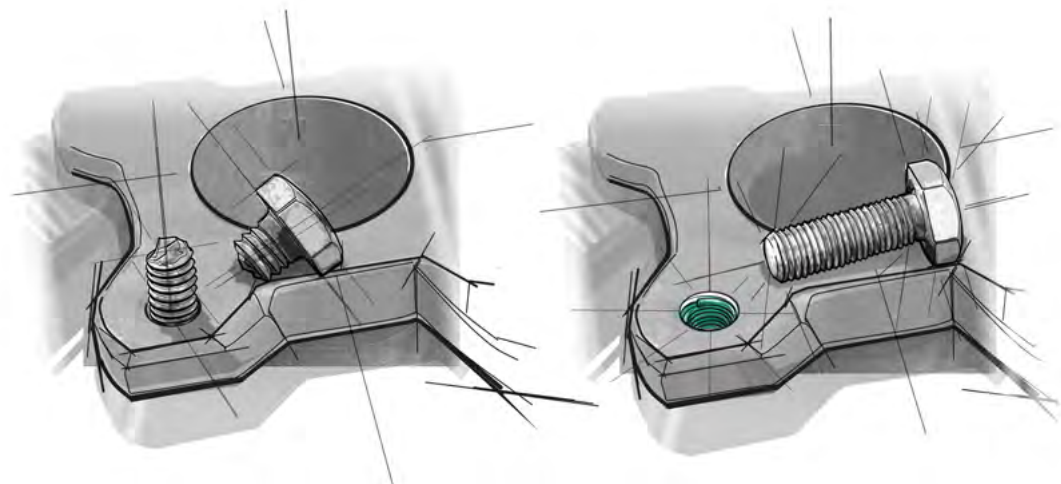

HELICOIL® thread inserts — advantages in detail

Tight fit

In not installed condition, the outside diameter of the HELICOIL® exceeds the holding thread size by a defined measure. In combination with the high spring force of the material, this difference in dimension causes a radial expansion and therefore a tight and zero-clearance fit in the nut thread. Additional locking elements or adhesive are therefore not required — as they usually are for fixed bushings. If you use impact wrenches, please contact us. We will be happy to assist you.



Friction

The thread friction as well as its dispersion range are reduced when a HELICOIL® is used. For example: If the thread friction value of a steel screw of property class 10.9 screwed into a tapped nut thread ranges between 0.12 and 0.18 μG , this value ranges between 0.11 and 0.13 μG if a HELICOIL® coil thread insert is used.

If a torque-controlled screw tightening method is employed, the screw preload-force can be adjusted more precisely and the yield point of the screw can be utilised to a higher degree. At the same time, the preload-force to screw failure is increased by the reduced torsion stress.

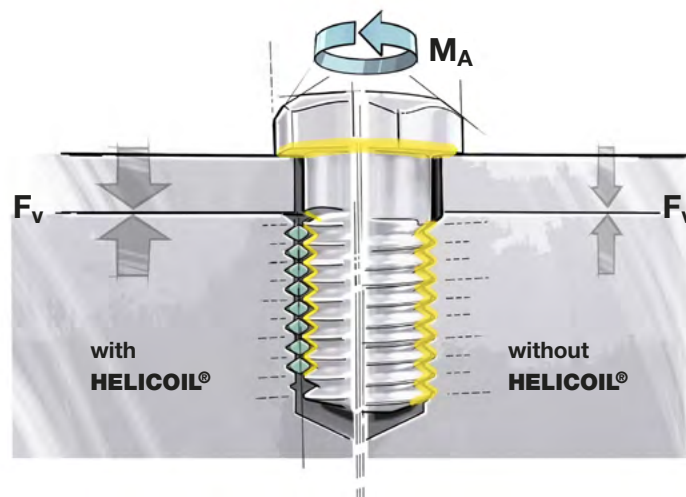

HELICOIL® thread inserts — advantages in detail

Downsizing

Engineers can choose almost any material. The HELICOIL® corresponds to the enduring trend toward lightweight construction (e.g. aluminium and magnesium) because this method of thread reinforcement combines minimum space requirements and high strength. This allows the optimum use of high-strength screws also in low-strength materials.

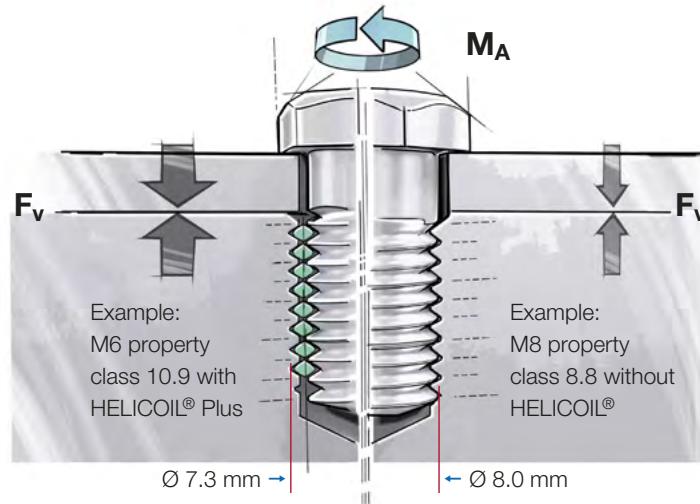

Your advantages:

Fewer joints and smaller screw sizes save material, installation space and weight — at a high fatigue strength. Those are definite advantages of the HELICOIL® system.

Volume rendering, example:



HELICOIL® thread inserts — advantages in detail

Screw loss protection

The HELICOIL® Screwlock variant is a coil thread insert that prevents the self-screwing-out of screws so that they are not lost.



HELICOIL® Plus Screwlock



Polygonal-shaped, resilient threads

If the HELICOIL® thread technology is combined with polygonal-shaped threads clamping the flanks of the screwed in screw, a high friction grip results. That resilient friction grip leads to prevailing torques which are similar to the specifications in ISO 2320 as well as to the requirements in technical delivery conditions stated in international standards. Besides that, they can be used 5 times. The prevailing torques can also be adjusted to individual requirements, e.g. to lock adjustment screws or to be used up to 14 times in the aviation sector.

The variants of the installed HELICOIL® Plus:

Screwing-in of the screw with HELICOIL® Plus Screwlock:

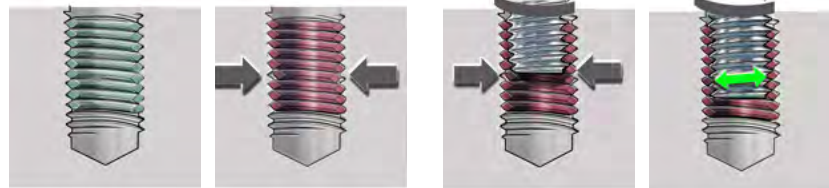

Free Running

Screwlock

The HELICOIL® Plus Screwlock can generally only be used with screws of a higher property class (8.8 and higher). For high-alloyed screws, commercial lubricants must be used in compliance with the manufacturer's recommendations.

The screw locking effect can also be achieved for the high-temperature range if suitable materials and surfaces are chosen.



Please see page 20 for the prevailing torques of HELICOIL® Screwlock.

HELICOIL® thread inserts — variants



HELICOIL® Smart Free Running*

This new thread insert merges the advantages of the HELICOIL® Plus and the HELICOIL® Tangfree. Every thread of the thread insert with a precision-formed, rhombic profile is free running. The result is a true-to-gauge internal thread including the last thread which is in every case threadable. Like the HELICOIL® Plus, the HELICOIL® Smart features a special thread start so that the installation into a holding thread is easier. There is a tang, but it does not need to be broken and removed. The installation time is therefore reduced by approx. 20 %. The HELICOIL® Smart can be installed fully automated. In combination with the adapted installation tools, the new generation of the HELICOIL® technology is a perfect addition to the HELICOIL® product family.

HELICOIL® Plus Free Running*

Every thread of the thread insert with precision-formed, rhombic profile is free running. The result is a true-to-gauge internal thread which can be used on both sides. The dimensional stability of the ISO thread complies with DIN 13 6H and for special requirements with 4H. It also fulfils the requirements of international standards. The advantages of the HELICOIL® Plus system are particularly apparent with respect to processing and tools and result in shorter cycle times.



HELICOIL® Plus Screwlock*

This thread insert also features an area for screw loss protection. One or several polygonal-shaped threads clamp the flanks of the installed screw. The resilient friction grip results in prevailing torques similar to the specifications in ISO 2320. These prevailing torques comply with the technical terms of delivery as per the requirements of international standards. The prevailing torques may also be adapted to the specific application, such as for locking adjustment screws. HELICOIL® Plus Screwlock must only be used with screws of higher property classes (8.8 and higher). For high-alloyed screws, commercial lubricants must be used in compliance with the manufacturer's recommendations. The advantages of the HELICOIL® Plus system are particularly apparent with respect to processing and tools and result in shorter cycle times.

* Comply with DIN 8140 standard.

HELICOIL® thread inserts — variants



HELICOIL® Tangfree Free Running**

No tang is required for the installation of these thread inserts. Therefore, neither a tang break nor a tang removal are required. Combined with the suitable installation tools, this innovation level of the HELICOIL® technology is an ideal addition to the HELICOIL® product family.

HELICOIL® Tangfree Screwlock**

The HELICOIL® Tangfree Screwlock has the same advantages as the HELICOIL® Tangfree. In addition, there is an area for screw loss protection. One or several polygonal-shaped threads clamp the flanks of the screwed in screw. The resilient friction grip results in prevailing torques similar to the specifications in ISO 2320. These prevailing torques comply with the technical terms of delivery as per the requirements of international standards. HELICOIL® Tangfree Screwlock must only be used with screws of higher property classes (8.8 and higher). For high-alloyed screws, commercial lubricants must be used in compliance with the manufacturer's recommendations. This thread insert is mainly used in the aviation industry.



HELICOIL® Classic Free Running*







Every thread of the thread insert with precision-formed, rhombic profile is free running. The result is a true-to-gauge internal thread which can be used on both sides. The dimensional stability of the ISO thread complies with DIN 13 6H and for special requirements with 4H. It also fulfils the requirements of international standards.

* Comply with DIN 8140 standard.

** Comply with standards NAS 1130 and NAS 0276.

HELICOIL® modular system

The HELICOIL® has been tried and tested for more than 70 years and has become a renowned structural component. There is a solution to almost every task related to this thread technology.

Variants*	Thread types*	Materials*	Surfaces*
 <p>HELICOIL® Smart Free Running</p>	<p>Metric coarse thread DIN ISO 13-1</p>	<p>Stainless steel A2 Material No 1.4301 Material No 1.4310</p>	<p>Bright</p>
 <p>HELICOIL® Plus Free Running</p>	<p>Metric fine thread DIN ISO 13 (T02-T11)</p>	<p>Stainless steel A4 Material No 1.4571</p>	<p>Tin-plated G100/G300</p>
 <p>HELICOIL® Plus Screwlock</p>	<p>Pipe thread DIN EN ISO 228/1G</p>	<p>Bronze Material No 2.1020.34</p>	<p>Dry film lubricated</p>
 <p>HELICOIL® Tangfree Free Running</p>	<p>UNC thread NASM 21209</p>	<p>Inconel X 750 Material No 2.4669</p>	<p>Cadmium-plated</p>
 <p>HELICOIL® Tangfree Screwlock</p>	<p>UNF thread NASM 21209</p>		<p>Silver-plated</p>
 <p>HELICOIL® Classic Free Running</p>	<p>BSW BS 84</p>	<p>Nimonic 90 Material No 2.4632</p>	<p>Hard-coated</p>
	<p>BSF BS 84</p>		
 <p>HELICOIL® Classic Screwlock</p>	<p>BA BS 93</p>	<p>Aluminium Material No 3.4365</p>	<p>Coloured Red, green, blue, yellow</p>

* Not all combinations can be realised.



HELICOIL® locknuts

HELICOIL® locknuts consist of a nut body and an integrated HELICOIL® Plus Screwlock thread insert. One or several polygonal-shaped threads clamp the flanks of the screwed in screw resulting in a resilient friction grip. The thus achieved prevailing torques are similar to the specifications of ISO 2320 and comply with the technical terms of delivery as per the requirements of international standards. They can also be adapted to individual requirements. HELICOIL® nuts are available in different materials.



RIVKLE® Aero

RIVKLE® Aero combines a high-strength stainless steel blind rivet nut and a HELICOIL® Screwlock. These two perfectly matching fasteners provide considerable advantages for screw joints on thin-walled components with high mechanical requirements. The screw is locked by the polygonal threads of the HELICOIL® Screwlock thread insert. These threads have a locking effect on the flanks of the screw or bolt to be screwed in.

As a result, there is a high resilient friction grip so that the screw is permanently locked to prevent self-unscrewing.



HELICOIL® scope of application



HELICOIL® thread inserts create high-strength, stable joints in low-strength metal materials to be used in diverse industries such as:

Aerospace industry

- Systems/equipment
- Engines
- Cabin interior
- Maintenance, refurbishment, overhaul (MRO)

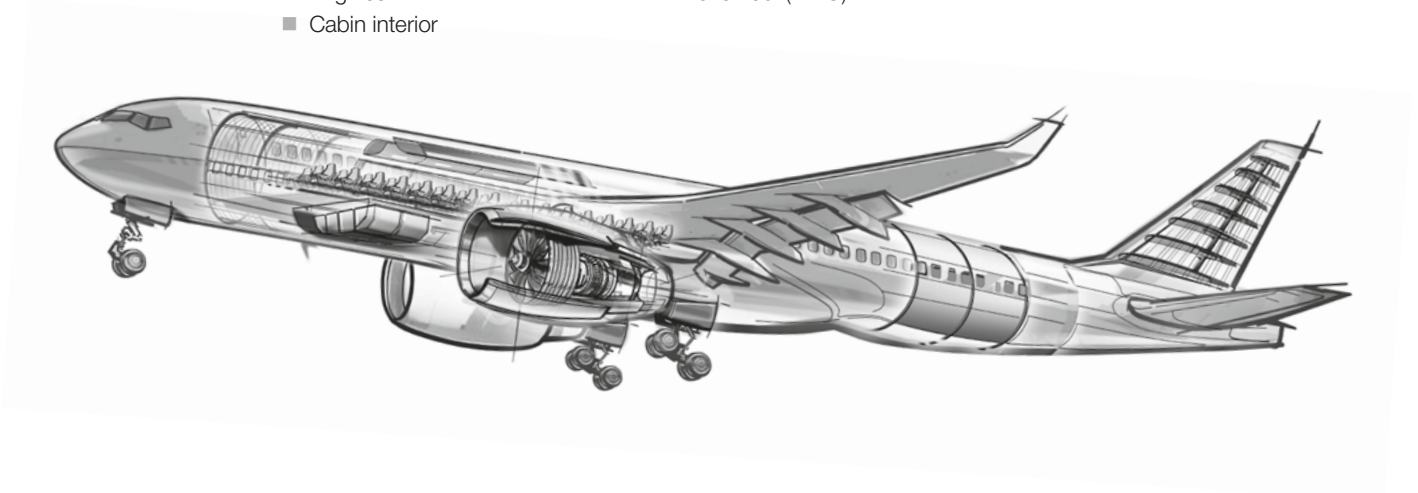

Automotive engineering and vehicle construction

- Body structure
- Body (exterior)
- Electronics
- Drive
 - Fuel-cell technology
 - E-mobility
 - Battery tray/frame
- Drive train
 - Engine block
 - Gearbox
- Running gear
 - Cross member
 - Suspension strut

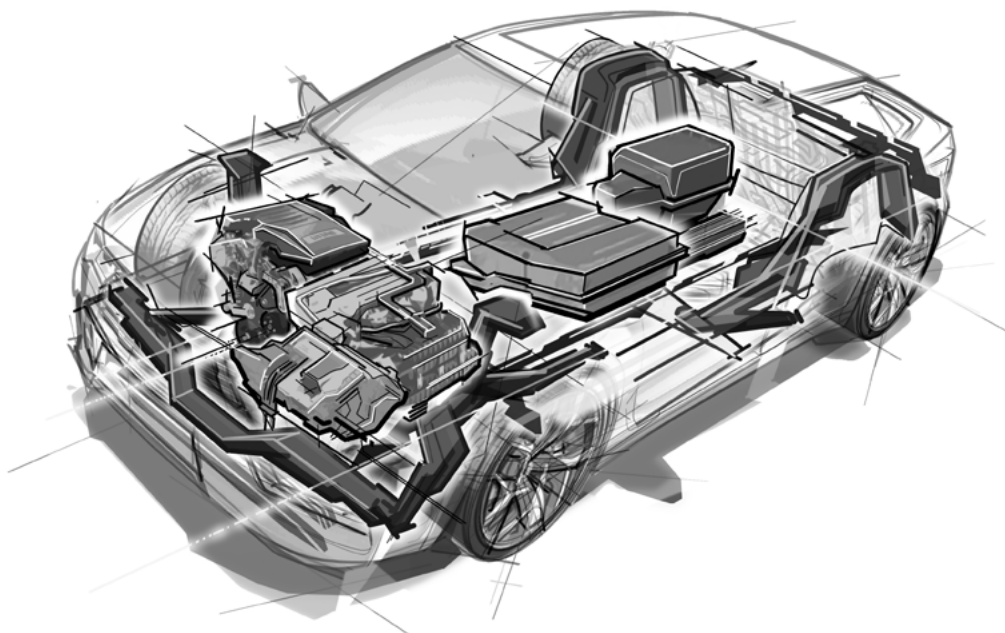

HELICOIL® scope of application



Diverse industries

- Energy technology
- Mechanical and plant engineering
- Electrical industry
- Electronics industry
- Tool manufacture
- Telecommunications
- Agricultural machinery

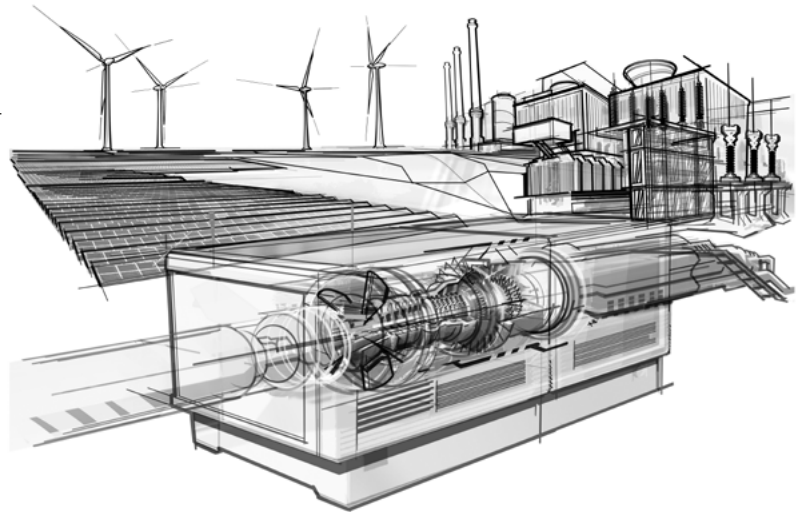

Application examples

- Vacuum technology
- Cast aluminium
- Semiconductor industry

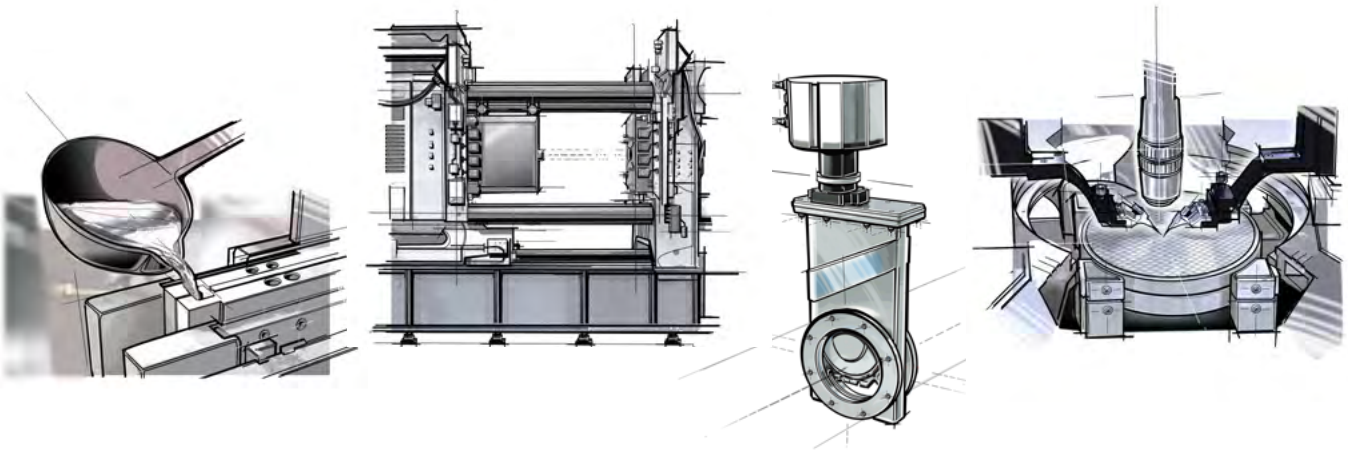

Application examples

- Cast housings in different sizes, e.g.:
 - Battery boxes
 - Fuel cell housings
 - Switch boxes

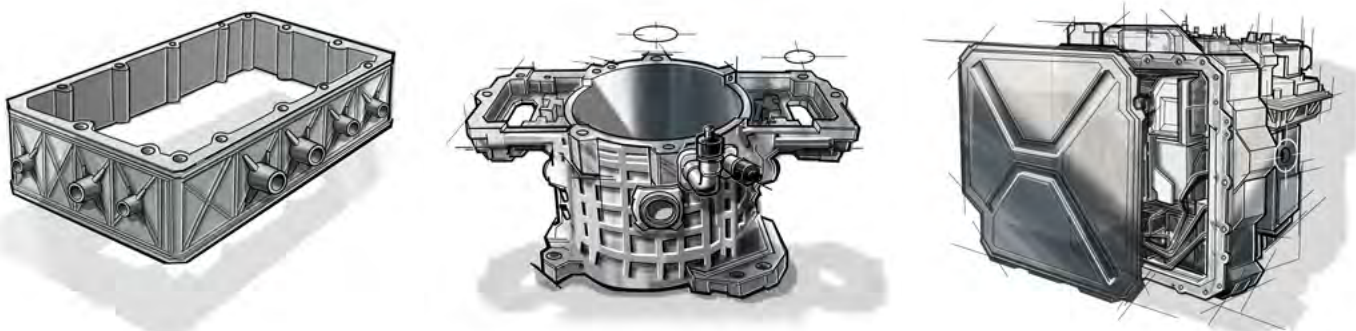

HELICOIL® Plus — installation process

HELICOIL® Plus thread inserts can be easily and economically installed because there are only a few basic rules to adhere to. There is a wide range of installation tools available to allow an efficient installation — for individual applications as well as for large-scale production. The installation phases are as follows:



Tap drilling

Commercial twist drills are used. Please find information about diameter and tap hole depth on **pages 24–29**. Prior to tapping, countersink 90° and deburr. Outside diameter of the **countersink = $D_{HC} + 0.1$ mm**.

The countersink is barely visible on the tapped holding thread.

D_{HC} = outside diameter of the holding thread



Tapping

To tap the HELICOIL® Plus holding thread, system-specific original HELICOIL® taps must be used. Recommended choices for manual and machine taps are provided on **pages 36 to 42**. HELICOIL® thread plug gauges must be used to check if a holding thread is true to gauge. (**See page 44.**)



Thread forming

Today, the chipless production of internal threads with a forming tap is an efficient manufacturing method for many materials. This also applies to the HELICOIL® Plus (**see page 43**).

Insertion and installation of the thread insert

It can be installed with hand-held or machine installation tools or in an automated procedure. The HELICOIL® Plus thread insert is usually screwed on the installation mandrel with the tang pointing down **1**. For fine screw threads, it is inserted into the leader cartridge **2** or plugged on to the fly-over tool (sizes larger than M16) **3**. See chapter "Manual installation tools for HELICOIL®".

The thread insert is screwed in by means of one of the mentioned tools. It must be installed at least 0.25 P below the surface (**see page 23**).



HELICOIL® Plus — installation process



Tang break-off

To produce a through-hole thread, the tang is broken off at the notch. A tang break-off tool is used to do that (1 and 2). For threads from M14 fine and normal screw threads, the tang can be removed with snipe nose pliers (3). For blind-hole threads, the tang does not have to be removed if the maximum screw-in depth t_3 of the screw is observed.



Visual impressions of the installation process

It can be installed with hand-held or machine installation tools or in an automated procedure.



Spinning on the HELICOIL® Plus



During screwing-in, the blade has a pull-in function



Positioning the HELICOIL® Plus at the thread start and screwing-in

The thread insert is screwed in by turning the installation mandrel or triggering the drive.

The HELICOIL® Plus must be installed at least $0.25 P$ below the component surface to ensure the correct installation.



Screwing out the mandrel





To produce a through-hole thread, the tang is broken off at the notch by means of the tang break-off tool



Correct installation of the HELICOIL® Plus ($0.25-0.5 \times P$ below the component surface)

Materials

The overview table shows the most common materials with characteristic values.

 Materials ①	 Temperature resistance	 Minimum tensile strength at room temperature	Examples of use
stainless steel A2 X5 CrNi 18 10 material No 1.4301	-196 °C low temperature 425 °C short-time 315 °C long-time	1,400 N/mm ^{2*}	<ul style="list-style-type: none"> Standard applications throughout all property classes and materials ③ General lightweight construction, e.g. aluminium, aluminium or magnesium alloys ②
stainless steel A4 X6 CrNiMoTi 17 12 2 ④	-196 °C low temperature 425 °C short-time 315 °C long-time	1,400 N/mm ^{2*}	<ul style="list-style-type: none"> Increased corrosion protection High-alloyed CrNi steel screws ③ Low thread friction General lightweight construction Sea water/chlorine-containing water
bronze CuSN 6 material No 2.1020.34	300 °C short-time 250 °C long-time	900 N/mm ^{2*}	<ul style="list-style-type: none"> Cu workpieces Translation threads CrNi screws
Inconel X 750 NiCr 15 Fe 7 TiAl ④ material No 2.4669 Nimonic 90 NiCr 20 Co 18 Ti material No 2.4632	750 °C short-time 550 °C long-time 900 °C short-time 600 °C long-time	1,150 N/mm ^{2*}	<ul style="list-style-type: none"> Thermal load in combination with corrosion protection Space technology Aeroplane engines Turbochargers
Aluminium AlZnMgCu 1.5 ④ material No 3.4365	170 °C short-time 150 °C long-time	500 N/mm ^{2*}	<ul style="list-style-type: none"> Magnesium workpieces Vehicle technology Lightweight construction

- ① Further materials and surfaces on request.
- ② If magnesium alloys are used outdoors, we recommend special measures for corrosion protection.
- ③ If CrNi screws are used, you should use a suitable coating or a commercial lubricant.
- ④ Delivery on request.

Note: These data only apply to uncoloured HELICOIL® Plus.
Up to M5, the applied colour is temperature-resistant from -18 °C to +200 °C.
From M6, the applied colour is temperature-resistant from -5 °C to +120 °C (short-time +150 °C).

* 1 N/mm² equals 1 MPa.

Thread types

Thread	HELICOIL® Plus Free Running		HELICOIL® Plus Screwlock		Page
	Nominal diameters	Nominal lengths	Nominal diameters	Nominal lengths	
Metric ISO thread coarse thread	M2–M42*	0.5 d – 3 d	M2–M39	0.75 d – 3 d ⑤	24–29
Metric ISO thread fine thread	M8 x 1 – M39 x 3*	0.5 d – 3 d	M8 x 1 – M64 x 4	0.75 d – 3 d	24–29

- ⑤ Length 3 d only realisable from M3.
- * Further sizes available.

HELICOIL® Plus thread inserts comply with diverse requirements and standards from the industry and the aerospace industry, such as DIN 8140, DIN 65536, LN 9039 and LN 9499. Further standards (e.g. MS or EN standards) on request.

Prevailing torques for HELICOIL® Screwlock

Thread	Guideline values for the prevailing torques according to ISO 2320 valid for coarse threads and fine threads. values in Nm for property class 8										
	M3	M4	M5	M6	M8	M10	M12	M14	M16	M18	M20
1st screwing-on, max.	0.43	0.90	1.60	3.00	6.00	10.5	15.5	24.0	32.0	42.0	54.0
1st screwing-off, min.	0.12	0.18	0.29	0.45	0.85	1.5	2.3	3.3	4.5	6.0	7.5
5th screwing-off, min.	0.08	0.12	0.20	0.30	0.60	1.0	1.6	2.3	3.0	4.2	5.3

Prevailing torques according to aeronautical standards or for other metric threads on request.

Determination of the nominal length

Guide values to determine the minimum length of the HELICOIL® Plus thread insert depending on holding material and screw property class, valid for a temperature of 20 °C.

Strength of the holding material Tensile strength R_m (N/mm ²) *	Screw property class												
	3.6	4.6	4.8	5.6	5.8	6.6	6.8	6.9	8.8	9.8	10.9	12.9	14.9
up to 100	1.5 d	1.5 d	1.5 d	2 d	2 d	2.5 d	2.5 d	3 d	3 d	–	–	–	–
> 100–150	1.5 d	1.5 d	1.5 d	2 d	2 d	2.5 d	2.5 d	2.5 d	2.5 d	2.5 d	2.5 d	2.5 d	3 d
> 150–200	1 d	1.5 d	1.5 d	1.5 d	1.5 d	2 d	2 d	2 d	2 d	2 d	2.5 d	2.5 d	2.5 d
> 200–250	1 d	1 d	1.5 d	1.5 d	1.5 d	1.5 d	1.5 d	2 d	2 d	2 d	2.5 d	2.5 d	2.5 d
> 250–300	1 d	1 d	1 d	1 d	1 d	1.5 d	1.5 d	1.5 d	1.5 d	1.5 d	2 d	2 d	2 d
> 300–350	1 d	1 d	1 d	1 d	1 d	1 d	1 d	1.5 d	1.5 d	1.5 d	1.5 d	1.5 d	2 d
> 350–400	1 d	1 d	1 d	1 d	1 d	1 d	1 d	1 d	1 d	1.5 d	1.5 d	1.5 d	1.5 d
> 400	1 d	1 d	1 d	1 d	1 d	1 d	1 d	1 d	1 d	1.5 d	1.5 d	1.5 d	1.5 d

* 1 N/mm² equals 1 MPa.

The table of values to determine the nominal length applies to aluminium as well as materials with a ratio of $\frac{\text{shear stress}}{\text{tensile stress}} = 0.6$ to 0.7 .
 Iron cast alloys sometimes have a ratio of $\frac{\text{shear stress}}{\text{tensile stress}} = 0.8$ to 1.4 .
 (Source: VDI 2230)

For these guide values, the screw is the weaker joint member.
 Lengths can be shorter than the recommended nominal lengths if tests confirm this.
 Intermediate lengths are also available.

Valid for the following temperature limits: aluminium alloys $T_{max} = 300$ °C, magnesium alloys $T_{max} = 100$ °C.

For the design of screw joints under thermal stress, the changes of temperature-dependent material parameters must be taken into account.

Minimum wall thickness

(in relation to the outside diameter of the HELICOIL® holding thread)

The minimum wall thickness mainly depends on individual operating data. These define the material strength and the length of thread engagement. The indicated guide value formulas apply to aluminium, cast and wrought alloys and a length of thread engagement for the HELICOIL® Plus of 1.5 d.

d = nominal Ø

D_{HC} = outside Ø of the holding thread

a = residual wall thickness

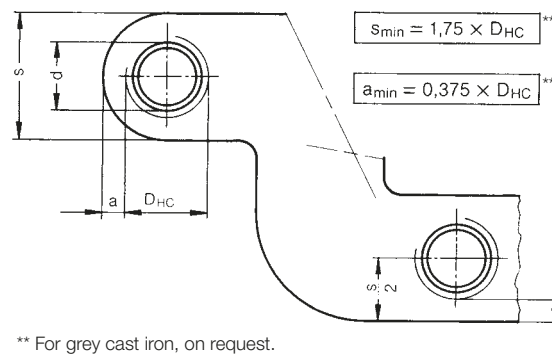

Diagrammatic representation for the example of M10 x 15:

HELICOIL® Plus thread insert installed

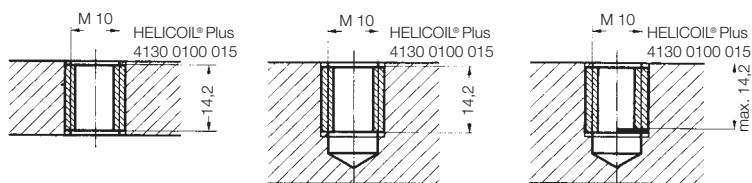

HELICOIL® Plus thread insert installed, with screw

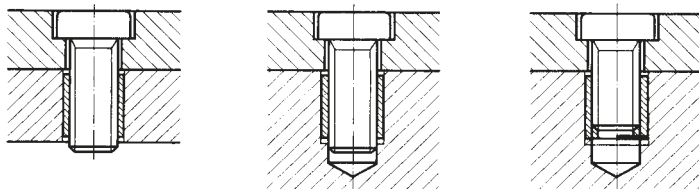

Free CAD download

Simply download the free CAD file. Download 3-D models of Böllhoff products and directly integrate them into your designs.
<https://www.boellhoff.com/de-en/cad>

HELICOIL® Plus thread inserts

Technical data

HELICOIL® Plus thread inserts

Free Running

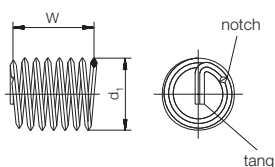

Screwlock

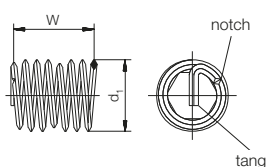

The control values for not installed thread inserts

Free Running and Screwlock are **W** and **d₁**.

The length can only be measured for installed thread inserts.

Holding thread

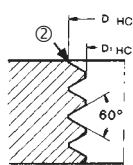
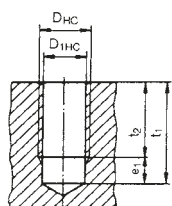
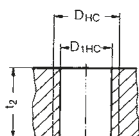

Installation

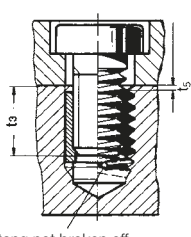
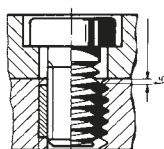

d = nominal thread diameter

P = thread pitch

d₁ = outside diameter of the thread insert prior to installation

W = number of threads prior to installation

D_{HC} = outside diameter of the holding thread

D_{1HC} = crest diameter

B = suited twist drill diameter **Please note:**

D_{1HC} is decisive for the selection of the twist drill diameter.

e₁ = thread run-out (including blind hole extension)

P	0.4	0.45	0.50	0.60	0.70	0.75	0.80	1.00	1.25	1.50
e₁	2.3	2.6	2.8	3.4	3.8	4.0	4.2	5.1	6.2	7.3

P	1.75	2.00	2.50	3.00	3.50	4.00	4.50	5.00	5.50	6.00
e₁	8.3	9.3	11.2	13.1	15.2	16.8	18.4	20.8	22.4	24.0

t₁ = minimum depth of tap hole according to DIN 76 - Part 1 (rule 1; $t_1 = t_2 + e_1$)

t₂ = The nominal length of the thread insert corresponds to the minimum length of the full holding thread for blind holes or the minimum plate thickness for a through hole.

t₃ = maximum screw-in depth for not broken off tang

t₅ = distance of the thread insert from the joint face = 0.25 to $0.5 P$ if t_2 equals the above-mentioned minimum value.

Please note: When HELICOIL® Plus thread inserts are used in series production, we recommend to add at least $1 \times P$ to values t_1 and t_2 each.

① Materials and surfaces are to be specified with the 5th digit of the order No:

Example: 4130 002 0005

↑

0 = stainless steel A2, X 5 CrNi 18 10

1 = bronze, CuSn 6

2 = Nimonic 90, NiCr 20 Co 18 Ti, silvered¹⁾

3 = stainless steel A4, X 6 CrNiMoTi 17 12 2

4 = Inconel X 750, NiCr 15 Fe 7 TiAl, silvered¹⁾

5 = Inconel X 750, NiCr 15 Fe 7 TiAl, bright

6 = stainless steel A2, X 5 CrNi 18 10, cadmium-plated

7 = stainless steel A2, X 5 CrNi 18 10, collated²⁾

8 = bronze, CuSn 6, collated²⁾

Other materials on request.

1) Use special tools for HELICOIL® Screwlock.

2) See page 30.

② Prior to tapping, countersink 90° and deburr.

Outside diameter of the countersink = $D_{HC} + 0.1$ mm.

All measures in mm. Technical changes reserved.

INDEX

23

82

HELICOIL® Plus thread inserts

d	P	t ₂ min.*		W	d ₁ min. max.	D _{1HC} min. max.	B	t ₃ max.	D _{HC} min.	Free Running	Screwlock
		x d	mm							Order No ①	Order No ①
M2	0.40	1 d	2.0	2.9	2.60 2.80	2.09 2.18	2.10	1.80	2.52	4130 002 0002	on request
		1.5 d	3.0	4.9				2.80		4130 002 0003	
		2 d	4.0	6.9				3.80		4130 002 0004	
		2.5 d	5.0	8.9				4.80		4130 002 0005	
		3 d	6.0	10.9				5.80		4130 002 0006	
M2.5	0.45	1 d	2.5	3.5	3.30 3.50	2.60 2.70	2.60	2.30	3.08	4130 025 0025	4132 025 0025
		1.5 d	3.75	5.9				3.50		4130 025 0375	4132 025 0375
		2 d	5.0	8.1				4.80		4130 025 0005	4132 025 0005
		2.5 d	6.25	10.5				6.00		4130 025 0625	4132 025 0625
		3 d	7.5	12.9				7.30		4130 025 0075	4132 025 0075
M3	0.50	1 d	3.0	3.9	3.80 4.00	3.11 3.22	3.20	2.70	3.65	4130 003 0003	4132 003 0003
		1.5 d	4.5	6.3				4.20		4130 003 0045	4132 003 0045
		2 d	6.0	8.7				5.70		4130 003 0006	4132 003 0006
		2.5 d	7.5	11.1				7.20		4130 003 0075	4132 003 0075
		3 d	9.0	13.5				8.70		4130 003 0009	4132 003 0009
M3.5	0.60	1 d	3.5	3.7	4.42 4.60	3.63 3.76	3.70	3.2	4.28	4130 035 0035	4132 035 0035
		1.5 d	5.25	6.3				5.0		4130 035 0053	4132 035 0053
		2 d	7.0	8.7				6.7		4130 035 0007	4132 035 0007
		2.5 d	8.75	11.2				8.5		4130 035 0875	4132 035 0875
		3 d	10.5	13.3				10.20		4130 035 0105	4132 035 0105
M4	0.70	1 d	4.0	3.7	5.05 5.25	4.15 4.29	4.20	3.6	4.91	4130 004 0004	4132 004 0004
		1.5 d	6.0	6.1				5.6		4130 004 0006	4132 004 0006
		2 d	8.0	8.4				7.6		4130 004 0008	4132 004 0008
		2.5 d	10.0	10.9				9.6		4130 004 0010	4132 004 0010
		3 d	12.0	13.2				11.60		4130 004 0012	4132 004 0012
M5	0.80	1 d	5.0	4.3	6.35 6.60	5.17 5.33	5.20	4.6	6.04	4130 005 0005	4132 005 0005
		1.5 d	7.5	6.9				7.1		4130 005 0075	4132 005 0075
		2 d	10.0	9.7				9.6		4130 005 0010	4132 005 0010
		2.5 d	12.5	12.3				12.10		4130 005 0125	4132 005 0125
		3 d	15.0	14.8				14.60		4130 005 0015	4132 005 0015
M6	1.00	1 d	6.0	4.2	7.60 7.85	6.22 6.41	6.30	5.5	7.30	4130 006 0006	4132 006 0006
		1.5 d	9.0	6.9				8.5		4130 006 0009	4132 006 0009
		2 d	12.0	9.6				11.50		4130 006 0012	4132 006 0012
		2.5 d	15.0	12.3				14.50		4130 006 0015	4132 006 0015
		3 d	18.0	14.6				17.50		4130 006 0018	4132 006 0018
M7	1.00	1 d	7.0	5.3	8.65 8.90	7.22 7.41	7.30	6.5	8.30	4130 007 0007	4132 007 0007
		1.5 d	10.5	8.2				10.00		4130 007 0105	4132 007 0105
		2 d	14.0	11.1				13.50		4130 007 0014	4132 007 0014
		2.5 d	17.5	14.3				17.00		4130 007 0175	4132 007 0175
		3 d	21.0	17.4				20.50		4130 007 0021	4132 007 0021
M8	1.25	1 d	8.0	4.7	9.85 10.10	8.27 8.48	8.40	7.4	9.62	4130 008 0008	4132 008 0008
		1.5 d	12.0	7.4				11.40		4130 008 0012	4132 008 0012
		2 d	16.0	10.6				15.40		4130 008 0016	4132 008 0016
		2.5 d	20.0	13.5				19.40		4130 008 0020	4132 008 0020
		3 d	24.0	16.4				23.40		4130 008 0024	4132 008 0024
M8 x 1	1.00	1 d	8.0	6.1	9.85 10.10	8.22 8.41	8.30	7.5	9.30	4130 008 3008	4132 008 3008
		1.5 d	12.0	9.5				11.50		4130 008 3012	4132 008 3012
		2 d	16.0	12.9				15.50		4130 008 3016	4132 008 3016
		2.5 d	20.0	16.5				19.50		4130 008 3020	4132 008 3020
		3 d	24.0	19.9				23.50		4130 008 3024	4132 008 3024

* Intermediate lengths are also available.
① See page 23.

Lead time of items: approx. 3 weeks (up to 10,000 pieces max.).
Items with blue numbers are in stock — subject to prior sale.

HELICOIL® Plus thread inserts

d	P	t ₂ min.*		W	d ₁ min. max.	D _{1HC} min. max.	B	t ₃ max.	D _{HC} min.	Free Running	Screwlock
		x d	mm							Order No ①	Order No ①
M9	1.25	1 d	9.0	5.3	10.85 11.10	9.27 9.48	9.40	8.4	10.62	4130 009 0009	on request
		1.5 d	13.5	8.6				12.9		4130 009 0135	
		2 d	18.0	11.9				17.4		4130 009 0018	
		2.5 d	22.5	15.3				21.9		4130 009 0225	
		3 d	27.0	18.1				26.4		4130 009 0027	
M10	1.50	1 d	10.0	5.0	12.10 12.50	10.32 10.56	10.50	9.2	11.95	4130 010 0010	4132 010 0010
		1.5 d	15.0	8.1				14.2		4130 010 0015	4132 010 0015
		2 d	20.0	11.2				19.2		4130 010 0020	4132 010 0020
		2.5 d	25.0	14.2				24.2		4130 010 0025	4132 010 0025
		3 d	30.0	17.2				29.2		4130 010 0030	4132 010 0030
M10 x 1	1.00	1 d	10.0	7.6	12.10 12.50	10.22 10.41	10.25	9.5	11.30	4130 010 3010	4132 010 3010
		1.5 d	15.0	12.1				14.5		4130 010 3015	4132 010 3015
		2 d	20.0	16.3				19.5		4130 010 3020	4132 010 3020
		2.5 d	25.0	20.7				24.5		4130 010 3025	4132 010 3025
		3 d	30.0	25				29.5		4130 010 3030	4132 010 3030
M10 x 1.25	1.25	1 d	10.0	6.0	12.10 12.50	10.27 10.48	10.40	9.4	11.62	4130 010 9010	4132 010 9010
		1.5 d	15.0	9.7				14.4		4130 010 9015	4132 010 9015
		2 d	20.0	13.1				19.4		4130 010 9020	4132 010 9020
		2.5 d	25.0	16.9				24.4		4130 010 9025	4132 010 9025
		3 d	30.0	20.1				29.4		4130 010 9030	4132 010 9030
M11	1.50	1 d	11.0	5.6	13.10 13.50	11.33 11.56	11.50	10.2	12.95	4130 011 0011	on request
		1.5 d	16.5	9.0				15.7		4130 011 0165	
		2 d	22.0	12.3				21.2		4130 011 0022	
		2.5 d	27.5	15.7				26.7		4130 011 0275	
		3 d	33.0	19.1				32.2		4130 011 0033	
M12	1.75	1 d	12.0	5.2	14.40 14.80	12.38 12.64	12.50	11.1	14.27	4130 012 0012	4132 012 0012
		1.5 d	18.0	8.4				17.1		4130 012 0018	4132 012 0018
		2 d	24.0	11.7				23.1		4130 012 0024	4132 012 0024
		2.5 d	30.0	14.7				29.1		4130 012 0030	4132 012 0030
		3 d	36.0	18.0				35.1		4130 012 0036	4132 012 0036
M12 x 1	1.00	1 d	12.0	9.3	14.40 14.80	12.22 12.41	12.25	11.5	13.30	4130 012 3012	on request
		1.5 d	18.0	14.5				17.5		4130 012 3018	
		2 d	24.0	19.5				23.5		4130 012 3024	
		2.5 d	30.0	24.8				29.5		4130 012 3030	
		3 d	36.0	30.0				35.5		4130 012 3036	
M12 x 1.25	1.25	1 d	12.0	7.4	14.40 14.80	12.27 12.48	12.25	11.4	13.62	4130 012 9012	4132 012 9012
		1.5 d	18.0	11.6				17.4		4130 012 9018	4132 012 9018
		2 d	24.0	15.9				23.4		4130 012 9024	4132 012 9024
		2.5 d	30.0	20.0				29.4		4130 012 9030	4132 012 9030
		3 d	36.0	24.3				35.4		4130 012 9036	4132 012 9036
M12 x 1.5	1.50	1 d	12.0	6.2	14.40 14.80	12.32 12.56	12.50	11.2	13.95	4130 012 4012	4132 012 4012
		1.5 d	18.0	9.8				17.2		4130 012 4018	4132 012 4018
		2 d	24.0	13.5				23.2		4130 012 4024	4132 012 4024
		2.5 d	30.0	17.1				29.2		4130 012 4030	4132 012 4030
		3 d	36.0	20.8				35.2		4130 012 4036	4132 012 4036

* Intermediate lengths are also available.
① See page 23.

Lead time of items: approx. 3 weeks (up to 10,000 pieces max.).
Items with blue numbers are in stock — subject to prior sale.

HELICOIL® Plus thread inserts

d	P	t ₂ min.*		W	d ₁ min. max.	D _{1HC} min. max.	B	t ₃ max.	D _{HC} min.	Free Running	Screwlock
		x d	mm							Order No ①	Order No ①
M14	2.00	1 d	14.0	5.6	16.80 17.20	14.43 14.73	14.50	13.0	16.60	4130 014 0014	4132 014 0014
		1.5 d	21.0	8.8				20.0		4130 014 0021	4132 014 0021
		2 d	28.0	12.0				27.0		4130 014 0028	4132 014 0028
		2.5 d	35.0	15.2				34.0		4130 014 0035	4132 014 0035
M14 x 1	1.00	1 d	14.0	11.2	16.80 17.20	14.22 14.41	14.25	13.5	15.30	4130 014 3014	on request
		1.5 d	21.0	17.2				20.5		4130 014 3021	
		2 d	28.0	23.2				27.5		4130 014 3028	
		2.5 d	35.0	29.2				34.5		4130 014 3035	
M14 x 1.25	1.25	spark plug thread	8.4	4.6	16.80 17.20	14.27 14.48	14.25	7.8	15.62	4130 014 9084	on request
			12.4	7.4				11.8		4130 014 9124	
			14.4	9.1				13.8		4130 014 9144	
			16.4	10.2				15.8		4130 014 9164	
M14 x 1.5	1.50	1 d	14.0	7.4	16.80 17.20	14.38 14.56	14.50	13.2	15.95	4130 014 4014	4132 014 4014
		1.5 d	21.0	11.6				20.2		4130 014 4021	4132 014 4021
		2 d	28.0	15.7				27.2		4130 014 4028	4132 014 4028
		2.5 d	35.0	19.9				34.2		4130 014 4035	4132 014 4035
M16	2.00	1 d	16.0	6.5	19.00 19.40	16.43 16.73	16.50	15.0	18.60	4130 016 0016	4132 016 0016
		1.5 d	24.0	10.1				23.0		4130 016 0024	4132 016 0024
		2 d	32.0	13.8				31.0		4130 016 0032	4132 016 0032
		2.5 d	40.0	17.5				39.0		4130 016 0040	4132 016 0040
M16 x 1.5	1.50	1 d	16.0	8.7	19.00 19.40	16.32 16.56	16.50	15.2	17.95	4130 016 4016	4132 016 4016
		1.5 d	24.0	13.4				23.2		4130 016 4024	4132 016 4024
		2 d	32.0	18.1				31.2		4130 016 4032	4132 016 4032
		2.5 d	40.0	22.9				39.2		4130 016 4040	4132 016 4040
M18	2.50	0.5 d	9.0	2.3	21.50 22.00	18.54 18.90	18.75	7.7	21.25	4130 018 0009	4132 018 0009
		0.75 d	13.5	3.8				12.2		4130 018 0135	4132 018 0135
		1 d	18.0	5.6				16.7		4130 018 0018	4132 018 0018
		1.50 d	27.0	9.0				25.7		4130 018 0027	4132 018 0027
		2 d	36.0	12.3				34.7		4130 018 0036	4132 018 0036
M18 x 1.5	1.50	0.5 d	9.0	4.2	21.50 22.00	18.32 18.56	18.50	8.2	19.95	4130 018 4009	4132 018 4009
		0.75 d	13.5	7.0				12.7		4130 018 4135	4132 018 4135
		1 d	18.0	9.5				17.2		4130 018 4018	4132 018 4018
		1.50 d	27.0	14.9				26.2		4130 018 4027	4132 018 4027
		2 d	36.0	20.2				35.2		4130 018 4036	4132 018 4036
M18 x 2	2.00	0.5 d	9.0	3.1	21.50 22.00	18.43 18.72	18.50	8.0	20.60	4130 018 5009	4132 018 5009
		0.75 d	13.5	5.1				12.5		4130 018 5135	4132 018 5135
		1 d	18.0	7.1				17.0		4130 018 5018	4132 018 5018
		1.50 d	27.0	11.2				26.0		4130 018 5027	4132 018 5027
		2 d	36.0	15.1				35.0		4130 018 5036	4132 018 5036

* Intermediate lengths are also available.
① See page 23.

Lead time of items: approx. 3 weeks (up to 10,000 pieces max.).
Items with blue numbers are in stock — subject to prior sale.

HELICOIL® Plus thread inserts

d	P	t ₂ min.*		W	d ₁ min. max.	D _{1HC} min. max.	B	t ₃ max.	D _{HC} min.	Free Running	Screwlock
		x d	mm							Order No ①	Order No ①
M20	2.50	0.5 d	10.0	2.7	23.70 24.20	20.54 20.90	20.75	8.7	23.25	4130 020 0010	4132 020 0010
		0.75 d	15.0	4.5				13.7		4130 020 0015	4132 020 0015
		1 d	20.0	6.3				18.7		4130 020 0020	4132 020 0020
		1.50 d	30.0	10.0				28.7		4130 020 0030	4132 020 0030
		2 d	40.0	13.7				38.7		4130 020 0040	4132 020 0040
M20 x 1.5	1.50	0.5 d	10.0	4.9	23.70 24.20	20.32 20.56	20.50	9.2	21.95	4130 020 4010	4132 020 4010
		0.75 d	15.0	7.9				14.2		4130 020 4015	4132 020 4015
		1 d	20.0	10.7				19.2		4130 020 4020	4132 020 4020
		1.50 d	30.0	16.7				29.2		4130 020 4030	4132 020 4030
		2 d	40.0	22.4				39.2		4130 020 4040	4132 020 4040
M20 x 2	2.00	0.5 d	10.0	3.5	23.70 24.20	20.43 20.73	20.50	9.0	22.60	4130 020 5010	4132 020 5010
		0.75 d	15.0	5.8				14.0		4130 020 5015	4132 020 5015
		1 d	20.0	8.0				19.0		4130 020 5020	4132 020 5020
		1.50 d	30.0	12.5				29.0		4130 020 5030	4132 020 5030
		2 d	40.0	16.8				39.0		4130 020 5040	4132 020 5040
M22	2.50	0.5 d	11.0	3.0	26.30 26.80	22.54 22.90	22.75	9.7	25.25	4130 022 0011	4132 022 0011
		0.75 d	16.5	5.0				15.2		4130 022 0165	4132 022 0165
		1 d	22.0	6.9				20.7		4130 022 0022	4132 022 0022
		1.50 d	33.0	10.9				31.7		4130 022 0033	4132 022 0033
		2 d	44.0	15.0				42.7		4130 022 0044	4132 022 0044
M22 x 1.5	1.50	0.5 d	11.0	5.5	26.30 26.80	22.32 22.56	22.50	10.2	23.95	4130 022 4011	on request
		0.75 d	16.5	8.6				15.7		4130 022 4165	
		1 d	22.0	11.7				21.2		4130 022 4022	
		1.50 d	33.0	18.1				32.2		4130 022 4033	
		2 d	44.0	24.5				43.2		4130 022 4044	
M22 x 2	2.00	0.5 d	11.0	3.9	26.30 26.80	22.43 22.73	22.50	10.0	24.60	4130 022 5011	4132 022 5011
		0.75 d	16.5	6.4				15.5		4130 022 5165	4132 022 5165
		1 d	22.0	8.7				21.0		4130 022 5022	4132 022 5022
		1.50 d	33.0	13.6				32.0		4130 022 5033	4132 022 5033
		2 d	44.0	18.4				43.0		4130 022 5044	4132 022 5044
M24	3.00	0.5 d	12.0	2.6	28.60 29.10	24.65 25.05	24.75	10.5	27.90	4130 024 0012	4132 024 0012
		0.75 d	18.0	4.5				16.5		4130 024 0018	4132 024 0018
		1 d	24.0	6.2				22.5		4130 024 0024	4132 024 0024
		1.50 d	36.0	10.0				34.5		4130 024 0036	4132 024 0036
		2 d	48.0	14.0				46.5		4130 024 0048	on request
M24 x 1.5	1.50	0.5 d	12.0	6.0	28.60 29.10	24.33 24.56	24.50	11.2	25.95	4130 024 4012	on request
		0.75 d	18.0	9.5				17.2		4130 024 4018	
		1 d	24.0	12.9				23.2		4130 024 4024	
		1.50 d	36.0	19.8				35.2		4130 024 4036	
		2 d	48.0	26.7				47.2		4130 024 4048	
M24 x 2	2.00	0.5 d	12.0	4.3	28.60 29.10	24.43 24.73	24.50	11.0	26.60	4130 024 5012	4132 024 5012
		0.75 d	18.0	7.0				17.0		4130 024 5018	4132 024 5018
		1 d	24.0	9.6				23.0		4130 024 5024	4132 024 5024
		1.50 d	36.0	15.0				35.0		4130 024 5036	4132 024 5036
		2 d	48.0	20.2				47.0		4130 024 5048	4132 024 5048

* Intermediate lengths are also available.

① See page 23.

Lead time of items: approx. 3 weeks (up to 10,000 pieces max.).

Items with blue numbers are in stock — subject to prior sale.

HELICOIL® Plus thread inserts

d	P	t ₂ min.*		W	d ₁ min. max.	D _{1HC} min. max.	B	t ₃ max.	D _{HC} min.	Free Running	Screwlock
		x d	mm							Order No ①	Order No ①
M26 x 1.5	1.50	0.50 d	13.0	6.5	31.00 31.50	26.33 26.56	26.50	12.2	27.95	4130 026 4013	on request
		0.75 d	19.5	10.3				18.7		4130 026 4195	
		1.00 d	26.0	14.0				25.2		4130 026 4026	
		1.50 d	39.0	21.6				38.2		4130 026 4039	
		2.00 d	52.0	29.1				51.2		4130 026 4052	
M27	3.00	0.50 d	13.5	3.2	32.20 32.70	27.65 28.05	27.75	12.0	30.90	4130 027 0135	4132 027 0135
		0.75 d	20.3	5.0				18.8		4130 027 0203	4132 027 0203
		1.00 d	27.0	7.1				25.5		4130 027 0027	4132 027 0027
		1.50 d	40.5	11.4				39.0		4130 027 0405	4132 027 0405
		2.00 d	54.0	15.4				52.5		4130 027 0054	4132 027 0054
M27 x 1.5	1.50	0.50 d	13.5	6.7	32.20 32.70	27.33 27.56	27.50	12.7	28.95	4130 027 4135	on request
		0.75 d	20.3	10.7				19.5		4130 027 4203	
		1.00 d	27.0	14.6				26.2		4130 027 4027	
		1.50 d	40.5	22.6				39.7		4130 027 4405	
		2.00 d	54.0	30.0				53.2		4130 027 4054	
M27 x 2	2.00	0.50 d	13.5	5.1	32.20 32.70	27.43 27.73	27.50	12.5	29.60	4130 027 5135	on request
		0.75 d	20.3	7.9				19.3		4130 027 5203	
		1.00 d	27.0	10.8				26.0		4130 027 5027	
		1.50 d	40.5	16.8				39.5		4130 027 5405	
		2.00 d	54.0	22.6				53.0		4130 027 5054	
M28 x 1.5	1.50	0.50 d	14.0	7.1	33.10 33.60	28.33 28.56	28.50	13.2	29.95	4130 028 4014	on request
		0.75 d	21.0	11.1				20.2		4130 028 4021	
		1.00 d	28.0	15.2				27.2		4130 028 4028	
		1.50 d	42.0	23.3				41.2		4130 028 4042	
		2.00 d	56.0	31.4				55.2		4130 028 4056	
M30	3.50	0.50 d	15.0	3.0	35.20 35.70	30.76 31.21	31.00	13.2	34.55	4130 030 0015	4132 030 0015
		0.75 d	22.5	4.9				20.7		4130 030 0225	4132 030 0225
		1.00 d	30.0	7.0				28.2		4130 030 0030	4132 030 0030
		1.50 d	45.0	11.0				43.2		4130 030 0045	4132 030 0045
		2.00 d	60.0	14.9				58.2		4130 030 0060	4132 030 0060
M30 x 1.5	1.50	0.50 d	15.0	7.8	35.20 35.70	30.33 30.56	30.50	14.2	31.95	4130 030 4015	on request
		0.75 d	22.5	12.2				21.7		4130 030 4225	
		1.00 d	30.0	16.5				29.2		4130 030 4030	
		1.50 d	45.0	25.3				44.2		4130 030 4045	
		2.00 d	60.0	34.0				59.2		4130 030 4060	
M30 x 2	2.00	0.50 d	15.0	5.7	35.20 35.70	30.43 30.73	30.50	14.0	32.60	4130 030 5015	on request
		0.75 d	22.5	9.0				21.5		4130 030 5225	
		1.00 d	30.0	12.3				29.0		4130 030 5030	
		1.50 d	45.0	19.0				44.0		4130 030 5045	
		2.00 d	60.0	25.5				59.0		4130 030 5060	
M33	3.50	0.50 d	16.5	3.4	38.30 38.80	33.76 34.21	34.00	14.7	37.55	4130 033 0165	on request
		0.75 d	24.8	5.6				23.0		4130 033 0248	on request
		1.00 d	33.0	7.8				31.2		4130 033 0033	4132 033 0033
		1.50 d	49.5	12.2				47.7		4130 033 0495	4132 033 0495
		2.00 d	66.0	16.5				64.2		4130 033 0066	4132 033 0066

* Intermediate lengths are also available.

① See page 23.

Lead time of items: approx. 3 weeks (up to 10,000 pieces max.).

Items with blue numbers are in stock — subject to prior sale.

HELICOIL® Plus thread inserts

d	P	t ₂ min.*		W	d ₁ min. max.	D _{1HC} min. max.	B	t ₃ max.	D _{HC} min.	Free Running	Screwlock
		x d	mm							Order No ①	Order No ①
M33 x 2	2.00	0.50 d	16.5	6.4	38.30 38.80	33.43 33.73	33.50	15.5	35.60	4130 033 5165	on request
		0.75 d	24.8	10.1				23.8		4130 033 5248	
		1.00 d	33.0	13.7				32.0		4130 033 5033	
		1.50 d	49.5	21.2				48.5		4130 033 5495	
		2.00 d	66.0	28.4				65.0		4130 033 5066	
M36	4.00	0.50 d	18.0	3.2	42.10 42.60	36.87 37.34	37.00	16.0	41.20	4130 036 0018	on request
		0.75 d	27.0	5.0				25.0		4130 036 0027	on request
		1.00 d	36.0	7.0				34.0		4130 036 0036	4132 036 0036
		1.50 d	54.0	11.1				52.0		4130 036 0054	4132 036 0054
		2.00 d	72.0	15.2				70.0		4130 036 0072	4132 036 0072
M36 x 1.5	1.50	0.50 d	18.0	9.5	42.10 42.60	36.33 36.56	36.50	17.2	37.95	4130 036 4018	on request
		0.75 d	27.0	14.7				26.2		4130 036 4027	
		1.00 d	36.0	19.9				35.2		4130 036 4036	
		1.50 d	54.0	30.5				53.2		4130 036 4054	
		2.00 d	72.0	41.0				71.2		4130 036 4072	
M36 x 2	2.00	0.50 d	18.0	6.8	42.10 42.60	36.43 36.73	36.50	17.0	38.60	4130 036 5018	on request
		0.75 d	27.0	10.3				26.0		4130 036 5027	
		1.00 d	36.0	14.1				35.0		4130 036 5036	
		1.50 d	54.0	21.9				53.0		4130 036 5054	
		2.00 d	72.0	31.1				71.0		4130 036 5072	
M36 x 3**	3.00	0.50 d	18.0	4.4	42.10 42.60	36.65 37.05	37.00	16.5	39.90	4130 036 6018	4132 036 6018
		0.75 d	27.0	7.2				25.5		4130 036 6027	4132 036 6027
		1.00 d	36.0	9.9				34.5		4130 036 6036	4132 036 6036
		1.50 d	54.0	15.3				52.5		4130 036 6054	4132 036 6054
		2.00 d	72.0	20.5				70.5		4130 036 6072	4132 036 6072
M39	4.00	0.75 d	29.3	5.5	45.10 45.60	39.87 40.34	40.00	23.4	44.20	4130 039 0293	4132 039 0293
		1.00 d	39.0	7.7				33.1		4130 039 0039	4132 039 0039
		1.25 d	48.8	9.9				42.9		4130 039 0488	4132 039 0488
		1.50 d	58.5	12.3				52.6		4130 039 0585	4132 039 0585
		2.00 d	78.0	16.6				72.1		4130 039 0078	4132 039 0078
M39 x 2	2.00	0.50 d	19.5	7.5	45.10 45.60	39.43 39.73	39.50	16.6	41.60	4130 039 5195	4132 039 5195
		0.75 d	29.3	11.9				26.3		4130 039 5293	4132 039 5293
		1.00 d	39.0	16.3				36.1		4130 039 5039	4132 039 5039
		1.25 d	48.8	20.6				45.8		4130 039 5488	4132 039 5488
		1.50 d	58.5	25.0				55.6		4130 039 5585	4132 039 5585
M39 x 3	3.00	0.50 d	19.5	4.9	45.10 45.60	39.65 40.05	40.00	15.1	42.90	4130 039 6195	4132 039 6195
		0.75 d	29.3	7.8				24.8		4130 039 6293	4132 039 6293
		1.00 d	39.0	10.8				34.6		4130 039 6039	4132 039 6039
		1.25 d	48.8	13.7				44.3		4130 039 6488	4132 039 6488
		1.50 d	58.5	16.8				54.1		4130 039 6585	4132 039 6585
M42	4.50	0.50 d	21.0	3.3	48.50 49.00	42.98 43.50	43.00	18.7	47.85	4130 042 0021	on request
		0.75 d	35.0	6.2				32.7		4130 042 0035	
		1.00 d	42.0	7.3				39.7		4130 042 0042	
		1.25 d	52.5	9.5				50.2		4130 042 0525	
		1.50 d	63.0	11.6				60.7		4130 042 0063	
		2.00 d	84.0	15.6				81.7		4130 042 0084	

* Intermediate lengths are also available.
① See page 23.

Lead time of items: approx. 3 weeks (up to 10,000 pieces max.).
Items with blue numbers are in stock — subject to prior sale.

HELICOIL® Plus >M42 on request.
** Further nominal thread diameters available.
See "Thread types" table on page 20.

Collated thread inserts for efficient installation



Collated HELICOIL® Plus thread inserts provide considerable advantages when processing smaller thread inserts. For that purpose, hand-held installation tools as well as stationary installation devices are available.

Advantages for processing in small- and large-scale production:

- High process reliability
- Easier handling
- Improved working conditions for series installation
- Improved performance due to safe feeding
- Reduced costs

Imperial dimensions:

See separate catalogue No 0101.



Nominal thread Ø	Nominal length	Collated on rolls, diameter = 320 mm			Collated on rolls, diameter = 220 mm		
		Number of inserts	Free Running Order No	Screwlock Order No	Number of inserts	Free Running Order No	Screwlock Order No
M2*	1.5 x d	–	–	–	–	–	–
	2 x d	4,500	4130 702 0008	4132 702 0008	1,000	4130 702 0028	4132 702 0028
	3 x d	3,000	4130 702 0012	4132 702 0012	–	–	–
M2.5	1 x d	5,000	4130 725 0004	4132 725 0004	1,000	4130 725 0024	4132 725 0024
	1.5 x d	4,000	4130 725 0006	4132 725 0006	1,000	4130 725 0026	4132 725 0026
	2 x d	3,000	4130 725 0008	4132 725 0008	1,000	4130 725 0028	4132 725 0028
M3	1 x d	4,000	4130 703 0004	4132 703 0004	1,000	4130 703 0024	4132 703 0024
	1.5 x d	2,800	4130 703 0006	4132 703 0006	1,000	4130 703 0026	4132 703 0026
	2 x d	2,000	4130 703 0008	4132 703 0008	1,000	4130 703 0028	4132 703 0028
M3.5*	1 x d	5,000	4130 735 0004	4132 735 0004	1,000	4130 735 0024	4132 735 0024
	1.5 x d	5,000	4130 735 0006	4132 735 0006	1,000	4130 735 0026	4132 735 0026
	2 x d	5,000	4130 735 0008	4132 735 0008	1,000	4130 735 0028	4132 735 0028
M4	1 x d	2,200	4130 704 0004	4132 704 0004	1,000	4130 704 0024	4132 704 0024
	1.5 x d	1,500	4130 704 0006	4132 704 0006	1,000	4130 704 0026	4132 704 0026
	2 x d	1,300	4130 704 0008	4132 704 0008	–	–	–
M5	1 x d	1,500	4130 705 0004	4132 705 0004	1,000	4130 705 0024	4132 705 0024
	1.5 x d	1,000	4130 705 0006	4132 705 0006	–	–	–
	2 x d	800	4130 705 0008	4132 705 0008	–	–	–
M6	1 x d	1,100	4130 706 0004	4132 706 0004	*	*	*
	1.5 x d	750	4130 706 0006	4132 706 0006	–	–	–
	2 x d	550	4130 706 0008	4132 706 0008	–	–	–
M8	1 x d	650	4130 708 0004	4132 708 0004	–	–	–
	1.5 x d	400	4130 708 0006	4132 708 0006	–	–	–
	2 x d	300	4130 708 0008	4132 708 0008	–	–	–
M10	1 x d	400	4130 710 0004	4132 710 0004	–	–	–
	1.5 x d	270	4130 710 0006	4132 710 0006	–	–	–
	2 x d	200	4130 710 0008	4132 710 0008	–	–	–

* On request.

HELICOIL® Plus pick-and-place system



Installation of the HELICOIL® Plus

Nominal thread Ø	Number of inserts	Strips for pick-and-place	
		Free Running Order No	Screwlock Order No
M2*	150	4130 702 0016	4132 702 0016
	150	4130 702 0018	4132 702 0018
	–	–	–
M2.5	150	4130 725 0014	4132 725 0014
	150	4130 725 0016	4132 725 0016
	150	4130 725 0018	4132 725 0018
M3	100	4130 703 0014	4132 703 0014
	100	4130 703 0016	4132 703 0016
	100	4130 703 0018	4132 703 0018
M3.5*	100	4130 735 0014	4132 735 0014
	100	4130 735 0016	4132 735 0016
	100	4130 735 0018	4132 735 0018
M4	100	4130 704 0014	4132 704 0014
	100	4130 704 0016	4132 704 0016
	100	4130 704 0018	4132 704 0018
M5	100	4130 705 0014	4132 705 0014
	100	4130 705 0016	4132 705 0016
	100	4130 705 0018	4132 705 0018
M6	100	4130 706 0014	4132 706 0014
	100	4130 706 0016	4132 706 0016
	100	4130 706 0018	4132 706 0018
M8	100	4130 708 0014	4132 708 0014
	100	4130 708 0016	4132 708 0016
	100	4130 708 0018	4132 708 0018
M10	*	*	*
	*	*	*
	*	*	*

* On request.

Pick-and-place system



Nominal thread Ø	Order No
M2	4148 002 0000
M2.5	4148 002 0000
M3	4148 002 0000
M3.5	4148 002 0000
M4	4148 004 0000
M5	4148 004 0000
M6	4148 006 0000
M8	4148 008 0000



The thread	34
Thread tolerances for metric holding threads	35
All taps at a glance	36
Manual tap.....	38
Machine taps.....	40
Combined drilling and tapping tools.....	42
Machine forming taps.....	43
Thread plug gauges.....	44
HELICOIL® depth gauge	45

The thread

Even if the screw thread has the maximum size and the nut thread has the minimum size, they must still fit. That means, no dimension may exceed the zero line or the nominal dimension.

The **tolerance position** on the zero line is indicated by means of a capital H for internal sizes and a small h for external sizes. The letters preceding h (g to a) mean a larger deviation for bolt threads. At tolerance position e, the bolt diameter is therefore smaller than at g.

The number preceding the letter is the **tolerance size**, e.g. 6g. The higher the number, the larger the tolerance zone. The dimensions of the tolerance zones depend on the nominal size: the bigger the nominal size, the bigger the tolerance zone.

If no specific tolerance zone has been specified for a screw, it was produced according to tolerance zone 6g. All conventional screws are thus undersize.

This minus tolerance allows subsequent thin galvanic surface coating without exceeding the zero line of the finished thread.

If the protective layer shall be thicker, a tolerance position with a smaller thread diameter is required, e.g. 6e for stronger galvanic layers.

Tolerance zones for screws and nuts for metric ISO threads M10

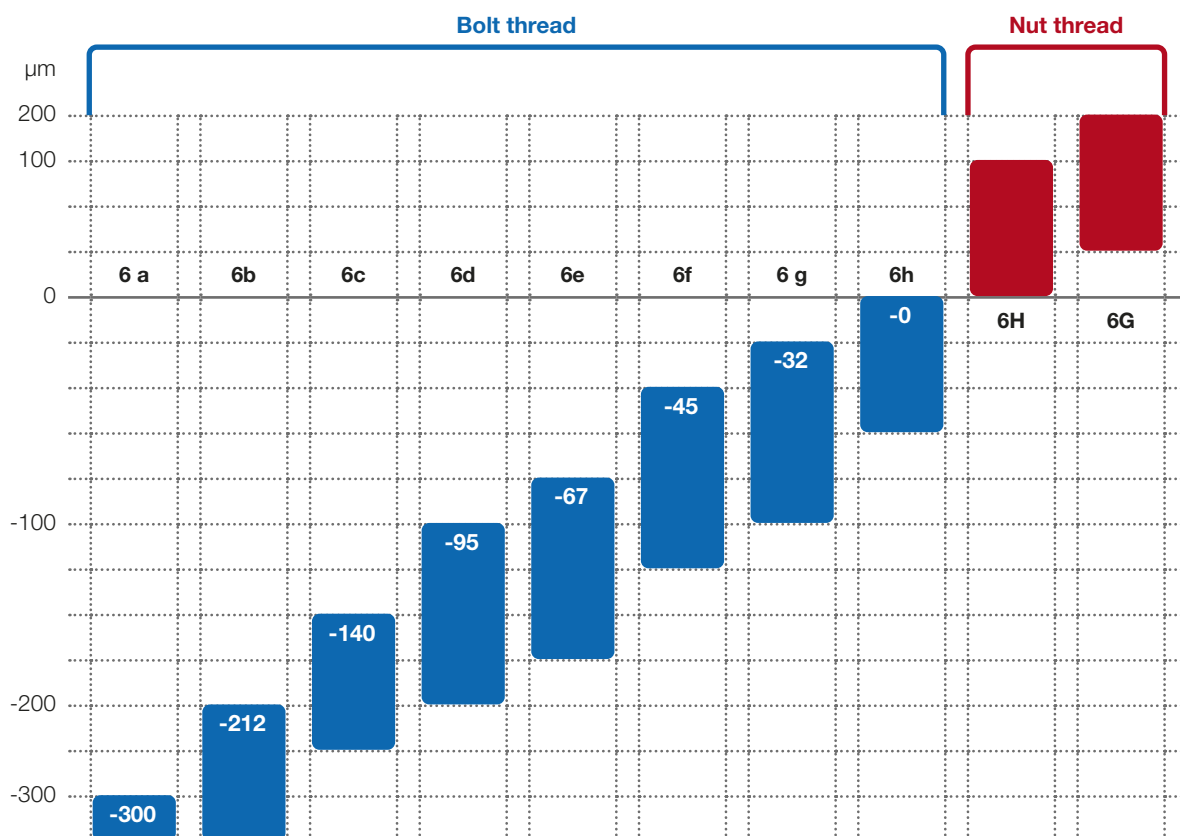

Thread tolerances for metric holding threads

Standard tolerance

According to DIN 8140 Part 2, HELICOIL® holding threads comply with tolerance **6H mod**. 6H mod complies with the accuracy of tolerance **5H** (also see the imprint on the plug gauge for the HELICOIL® holding thread).

After the HELICOIL® Plus thread insert has been installed, the existing ISO thread complies with tolerance **6H**.

HELICOIL®	Examples of item codes
Tap	For tolerance classes 6H mod and 5H , the ninth digit of the item code is 1 . Example: M10 0141 410 0 1 52
Forming tap	For tolerance classes 6H mod and 5H , the ninth digit of the item code is 0 . Example: M10 0144 110 0 0 04
Thread plug gauges	For tolerance classes 6H mod and 5H , the ninth digit of the item code is 5 . Example: M10 0147 310 0 5 00

Industry-specific tolerance

The developments in the aerospace industry are strongly influenced by the striving for maximum operational reliability and economic efficiency. That is why the respective standards demand ISO thread tolerance **5H**. Consequently, HELICOIL® holding threads must comply with tolerance **5H mod**. This in turn corresponds with tolerance accuracy **4H**.

After the HELICOIL® Plus thread insert has been installed, the existing ISO thread complies with tolerance 5H.

HELICOIL®	Examples of item codes
Tap	For tolerance classes 5H mod and 4H , the ninth digit of the item code is 2 . Example: M10 0141 410 0 2 52
Forming tap	For tolerance classes 5H mod and 4H , the ninth digit of the item code is 2 . Example: M10 0144 110 0 2 04
Thread plug gauges	For tolerance classes 5H mod and 4H , the ninth digit of the item code is 4 . Example: M10 0147 310 0 4 00

MJ thread (ISO 5855)

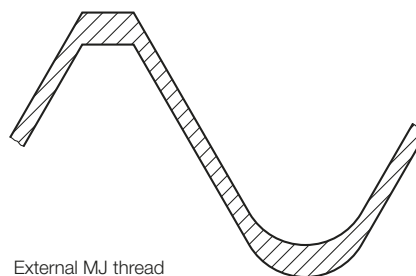

No specific HELICOIL® holding thread is required for the use of threaded bolts with this thread profile.



All taps at a glance

HELICOIL® Plus manual and machine taps

To tap the HELICOIL® Plus holding thread, system-specific original HELICOIL® taps must be used. We have suitable manual and machine taps on offer. The overview provides all necessary information.

Arrangement	Manual tap Through hole and blind hole	Machine taps		Recommended guide values ① tapping speed [m/min]*	Cooling/ lubrication
		 Through hole	 Blind hole		
Aluminium and cast aluminium alloys (short-chip)	0140 0 0140.1-2 ② 0140.3-5 ③	0141 1XXX XXX	0141 5XXX XXX*	10 / 20	emulsion
Aluminium and aluminium alloys (long-chip)	0140 0 0140.1-2 ② 0140.3-5 ③	0141 1XXX XXX	0141 4XXX XXX*	15 / 20	emulsion
Magnesium alloys	0140 0 0140.1-2 ② 0140.3-5 ③	0141 1XXX XXX	0141 4XXX XXX*	10 / 20	dry
Steel up to 700 N/mm ² cast iron soft Rm ≤ 250 N/mm ^{2**} cast iron hard Rm > 250 N/mm ^{2**} malleable cast iron	0140 0 0140.1-2 ② 0140.3-5 ③	0141 1XXX XXX	0141 5XXX XXX*	6 / 15 8 / 15 6 / 12 8 / 12	oil, emulsion petroleum/emulsion emulsion oil, emulsion
Copper bronze/red brass brass, tough zinc alloy	0140 0 0140.1-2 ② 0140.3-5 ③	0141 1XXX XXX	0141 5XXX XXX*	10 / 15 5 / 12 8 / 16 8 / 15	oil, emulsion oil, emulsion oil, emulsion oil, emulsion
Brass, brittle	0140 0 0140.1-2 ② 0140.3-5 ③	0141 1XXX XXX	0141 5XXX XXX*	10 / 20	oil dry

① In individual cases, previous tapping tests are required for other materials.

② Set of taps (two-piece).

③ Set of taps (three-piece).

We also supply TiN-coated taps.



* Smaller value for blind holes, higher value for through holes.

** 1 N/mm² equals 1 MPa.

All taps at a glance

HELICOIL® special machine taps

The HELICOIL® standard taps comply with most of the requirements existing in practice. For critical chip removal requirements, such as materials which are difficult to machine (stainless and heat-resisting steels, different steel and titanium alloys), we offer special machine taps. The overview provides the machine taps for the respective materials including recommended tapping speed guide values.

Arrangement	Machine taps		Recommended guide values Tapping speed [m/min]*	Cooling/ lubrication
	 Through hole	 Blind hole		
Aluminium alloys with a high silicon content Si > 10 %	0141 9XXX 444	0141 9XXX 451	10 / 20	oil/emulsion
Materials difficult to machine: – Stainless steel – Ferritic/martensitic – Austenitic – Heat-resisting steel	0141 9XXX 444	0141 9XXX 451	3 / 8 1 / 4 1 / 4	oil/emulsion
Hard materials: – Grey cast iron – Spheroidal graphite cast iron	0141 9XXX 418	0141 9XXX 418	8 / 16 6 / 12	petroleum/emulsion
Tough, seizing materials: Electrolytic copper Bronze, hard	0141 9XXX 445	0141 9XXX 451	8 / 12 1 / 5	oil
Brass, brittle	0141 9XXX 424	0141 9XXX 424	15 / 25	oil
Titanium alloys: ≤ 700 N/mm ² ** > 700 N/mm ² **	0141 9XXX 444 0141 9XXX 447	0141 9XXX 451 0141 9XXX 432	2 / 8 1 / 4	oil
Plastic, soft thermoplastic	0141 9XXX 445	0141 9XXX 451		compressed air/emulsion
Plastic, brittle thermoset	0141 9XXX 446	0141 9XXX 446		compressed air

Example of a designation: size M4: 0141 9040 451

Further taps as special versions, such as TIN-coated taps or oversize taps, on request.

* Smaller value for blind holes, higher value for through holes.

** 1 N/mm² equals 1 MPa.

Manual taps for **HELICOIL® Plus**



Type 0140.0

HELICOIL® manual tap, single-cut
For cutting materials with a strength up to 700 N/mm^{2***}

For through holes

For blind holes only if sufficient chip space is provided.

Minimum requirement: 1 d deeper than the full thread length.



Type 0140.1, 0140.2

HELICOIL® manual tap,
two-piece set with stepped pitch diameter:

taper tap 4-pitch chamfer 0140.1...

finishing tap 2-pitch chamfer 0140.2...

For cutting materials with a strength up to 700 N/mm^{2***}

For through holes and blind holes.



Type 0140.3, 0140.4, 0140.5

HELICOIL® manual tap,
three-piece set from M36 with constant pitch diameter

taper tap 4-pitch chamfer 0140.3...

second tap 4-pitch chamfer 0140.4...

finishing tap 2-pitch chamfer 0140.5...

Version A

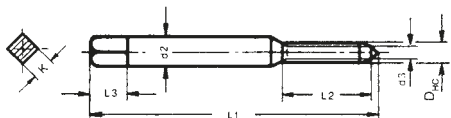

Version B

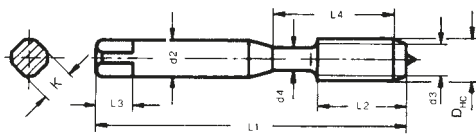

Version C

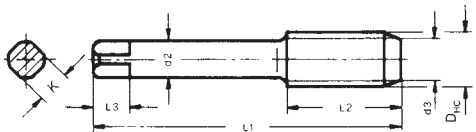

Nominal thread Ø d	Single taps for tolerance class 5H (6H mod)* Type 0140.0 Order No	Taps for tolerance class 5H (6H mod)* (1 set)	
		Taper taps Type 0140.1 Order No	Finishing taps Type 0140.2 Order No
M2	0140 002 0104	0140 102 0104	0140 202 0102
M2.5	0140 025 0104	0140 125 0104	0140 225 0102
M3	0140 003 0104	0140 103 0104	0140 203 0102
M3.5	0140 035 0104	0140 135 0104	0140 235 0102
M4	0140 004 0104	0140 104 0104	0140 204 0102
M5	0140 005 0104	0140 105 0104	0140 205 0102
M6	0140 006 0104	0140 106 0104	0140 206 0102
M7	0140 007 0104	0140 107 0104	0140 207 0102
M8	0140 008 0104	0140 108 0104	0140 208 0102
M8 x 1	0140 008 3104	0140 108 3104	0140 208 3102
M9	0140 009 0104	0140 109 0104	0140 209 0102
M10	0140 010 0104	0140 110 0104	0140 210 0102
M10 x 1	0140 010 3104	0140 110 3104	0140 210 3102
M10 x 1.25	0140 010 9104	0140 110 9104	0140 210 9102
M11	0140 011 0104	0140 111 0104	0140 211 0102
M12	0140 012 0104	0140 112 0104	0140 212 0102
M12 x 1	0140 012 3104	0140 112 3104	0140 212 3102
M12 x 1.25	0140 012 9104	0140 112 9104	0140 212 9102
M12 x 1.5	0140 012 4104	0140 112 4104	0140 212 4102
M14	0140 014 0104	0140 114 0104	0140 214 0102
M14 x 1	0140 014 3104	0140 114 3104	0140 214 3102
M14 x 1.25	0140 014 9104	0140 114 9104	0140 214 9102
M14 x 1.5	0140 014 4104	0140 114 4104	0140 214 4102
M16	0140 016 0104	0140 116 0104	0140 216 0102
M16 x 1.5	0140 016 4104	0140 116 4104	0140 216 4102
M18	–	0140 118 0104	0140 218 0102
M18 x 1.5	0140 018 4104	0140 118 4104	0140 218 4102
M18 x 2	0140 018 5104	0140 118 5104	0140 218 5102
M20	–	0140 120 0104	0140 220 0102
M20 x 1.5	0140 020 4104	0140 120 4104	0140 220 4102
M20 x 2	0140 020 5104	0140 120 5104	0140 220 5102
M22	–	0140 122 0104	0140 222 0102
M22 x 1.5	0140 022 4104	0140 122 4104	0140 222 4102
M22 x 2	0140 022 5104	0140 122 5104	0140 222 5102
M24	–	0140 124 0104	0140 224 0102
M24 x 1.5	0140 024 4104	0140 124 4104	0140 224 4102
M24 x 2	0140 024 5104	0140 124 5104	0140 224 5102
M26 x 1.5	0140 026 4104	0140 126 4104	0140 226 4102
M27	–	0140 127 0104	0140 227 0102
M27 x 1.5	0140 027 4104	0140 127 4104	0140 227 4102
M27 x 2	0140 027 5104	0140 127 5104	0140 227 5102
M28 x 1.5	0140 028 4104	0140 128 4104	0140 228 4102
M30	–	0140 130 0104	0140 230 0102
M30 x 1.5	0140 030 4104	0140 130 4104	0140 230 4102
M30 x 2	0140 030 5104	0140 130 5104	0140 230 5102
M33	–	0140 133 0104	0140 233 0102
M33 x 2	0140 033 5104	0140 133 5104	0140 233 5102
M36**	–	–	–
M36 x 1.5	0140 036 4104	0140 136 4104	0140 236 4102
M36 x 2	0140 036 5104	0140 136 5104	0140 236 5102
M36 x 3	0140 036 6104	0140 136 6104	0140 236 6102

* For tolerance class 4H, the ninth digit of the finishing tap order No changes from 1 to 2. The taper tap does not change. For details see **page 35**.

For combined drilling and tapping tools, see **page 42**.

*** 1 N/mm² equals 1 MPa.

Manual taps for **HELICOIL® Plus**

Nominal thread Ø d	Version	Min. outside Ø D _{HC}	Shank Ø h 9 d 2	Chamfer Ø d 3	Total length L 1	Thread length max. L 2	Square length L 3	Square H 12 K	L 4	d 4
M2	A	2.5	2.8	2	40	9	5	2.1	2.1	–
M2.5	B	3.1	3.5	2.5	40	10	6	2.7	2.7	2.6
M3	B	3.6	4	3	45	10	6	3	3	3.1
M3.5	B	4.3	4.5	3.5	45	12	6	3.4	3.4	3.6
M4	B	4.9	6	4	50	14	8	4.9	4.9	4.2
M5	B	6.0	6	5	50	16	8	4.9	4.9	5.2
M6	C	7.3	6	6	56	19	8	4.9	4.9	–
M7	C	8.3	7	7	63	19	8	5.5	5.5	–
M8	C	9.6	7	8	70	22	8	5.5	5.5	–
M8 x 1	C	9.3	7	8	63	19	8	5.5	5.5	–
M9	C	10.6	8	9	70	24	9	6.2	6.2	–
M10	C	11.9	9	10	75	27	10	7	7	–
M10 x 1	C	11.3	9	10	70	22	10	7	7	–
M10 x 1.25	C	11.6	10	9	70	22	10	7	7	–
M11	C	12.9	11	11	70	22	12	9	9	–
M12	C	14.3	11	12	80	30	12	9	9	–
M12 x 1	C	13.3	11	12	70	22	12	9	9	–
M12 x 1.25	C	13.6	11	12	70	22	12	9	9	–
M12 x 1.5	C	14.0	11	12	70	22	12	9	9	–
M14	C	16.6	12	14	80	32	12	9	9	–
M14 x 1	C	15.3	12	14	70	22	12	9	9	–
M14 x 1.25	C	15.6	12	14	70	22	12	9	9	–
M14 x 1.5	C	16.0	12	14	70	22	12	9	9	–
M16	C	18.6	14	16	80	22	14	11	11	–
M16 x 1.5	C	18.0	14	16	80	22	14	11	11	–
M18	C	21.3	16	18	95	40	15	12	12	–
M18 x 1.5	C	20.0	16	18	80	22	15	12	12	–
M18 x 2	C	20.6	16	18	80	22	15	12	12	–
M20	C	23.3	18	20	100	40	17	14.5	14.5	–
M20 x 1.5	C	22.0	18	20	80	22	17	14.5	14.5	–
M20 x 2	C	22.6	18	20	80	22	17	14.5	14.5	–
M22	C	25.3	18	22	110	50	17	14.5	14.5	–
M22 x 1.5	C	24.0	18	22	90	22	17	14.5	14.5	–
M22 x 2	C	24.6	18	22	90	22	17	14.5	14.5	–
M24	C	27.9	20	24	110	50	19	16	16	–
M24 x 1.5	C	26.0	18	24	90	22	17	14.5	14.5	–
M24 x 2	C	26.6	20	24	90	22	19	16	16	–
M26 x 1.5	C	28.0	20	26	90	22	19	16	16	–
M27	C	30.9	22	27	125	56	21	18	18	–
M27 x 1.5	C	29.0	22	27	90	22	21	18	18	–
M27 x 2	C	29.6	22	27	90	22	21	18	18	–
M28 x 1.5	C	30.0	22	28	90	22	21	18	18	–
M30	C	34.6	28	30	125	40	25	22	22	–
M30 x 1.5	C	32.0	22	30	90	22	21	18	18	–
M30 x 2	C	32.6	25	30	100	22	23	20	20	–
M33	C	37.6	28	33	125	40	25	22	22	–
M33 x 2	C	35.6	28	33	125	40	25	22	22	–
M36**	C	41.2	32	36	150	63	27	24	24	–
M36 x 1.5	C	38.0	28	36	100	25	25	22	22	–
M36 x 2	C	38.6	32	36	125	40	27	24	24	–
M36 x 3	C	39.9	32	36	125	40	27	24	24	–

Further sizes on request.

** Set of taps (three-flute), plus second tap 0140 436 0104.

Types 0140.0 and 0140.2 can, to a limited degree, also be used as machine taps.

Shank Ø tolerance h9. They are particularly suitable for short-chip materials such as grey cast iron, brass or magnesium.

Machine taps for **HELICOIL® Plus**



Type 0141.1

HELICOIL® machine tap, straight-fluted, rake angle 10°, with spiral point

4-pitch chamfer for through holes, for blind holes with a deeper tap hole

For materials with a strength of 850 N/mm² max.**



Type 0141.4

HELICOIL® machine tap,

spiral flutes 45° right-hand spiral, rake angle 15°

2-pitch chamfer for blind holes

Also suited for cast aluminium alloys with very low Si content (≤ 2 %).

For wrought aluminium alloys with a maximum strength of approx. 500 N/mm²**

2-flute up to M8.

3-flute from M9 and additionally also for soft steels with a maximum strength of 450 N/mm².



Type 0141.5

HELICOIL® machine tap,

spiral flutes 40° right-hand spiral, rake angle 10°

2–3-pitch chamfer for blind holes.

For blind holes with a deeper tap hole.

For steels with a strength from 500 N/mm²** to 850 N/mm²** max.

Also suited for cast aluminium alloys with an Si content of up to approximately 10 %. For an Si content > 10 %, see page 37.

Version A

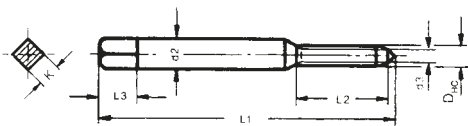

Version B

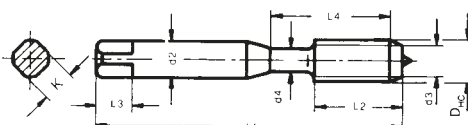

Version C

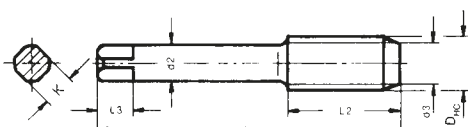

Nominal thread Ø d	for tolerance class 5H (6H mod)*	for tolerance class 5H (6H mod)*	for tolerance class 5H (6H mod)*
	Type 0141.1 Order No	Type 0141.4 Order No	Type 0141.5 Order No
M2	0141 102 0104	0141 402 0152	0141 502 0102
M2.5	0141 125 0104	0141 425 0152	0141 525 0102
M3	0141 103 0104	0141 403 0152	0141 503 0102
M3.5	0141 135 0104	0141 435 0152	0141 535 0102
M4	0141 104 0104	0141 404 0152	0141 504 0102
M5	0141 105 0104	0141 405 0152	0141 505 0102
M6	0141 106 0104	0141 406 0152	0141 506 0102
M7	0141 107 0104	0141 407 0152	0141 507 0102
M8	0141 108 0104	0141 408 0152	0141 508 0102
M8 x 1	0141 108 3104	0141 408 3152	0141 508 3102
M9	0141 109 0104	0141 409 0152	0141 509 0102
M10	0141 110 0104	0141 410 0152	0141 510 0102
M10 x 1	0141 110 3104	0141 410 3152	0141 510 3102
M10 x 1.25	0141 110 9104	–	0141 510 9102
M11	0141 111 0104	0141 411 0152	0141 511 0102
M12	0141 112 0104	0141 412 0152	0141 512 0102
M12 x 1	0141 112 3104	0141 412 3152	0141 512 3102
M12 x 1.25	0141 112 9104	–	0141 512 9102
M12 x 1.5	0141 112 4104	0141 412 4152	0141 512 4102
M14	0141 114 0104	–	0141 514 0102
M14 x 1	0141 114 3104	0141 414 3152	0141 514 3102
M14 x 1.25	0141 114 9104	–	–
M14 x 1.5	0141 114 4104	0141 414 4152	0141 514 4102
M16	0141 116 0104	–	0141 516 0102
M16 x 1.5	0141 116 4104	0141 416 4152	0141 516 4102
M18	0141 118 0104	–	0141 518 0102
M18 x 1.5	0141 118 4104	0141 418 4152	0141 518 4102
M18 x 2	0141 118 5104	–	0141 518 5102
M20	0141 120 0104	–	0141 520 0102
M20 x 1.5	0141 120 4104	0141 420 4152	0141 520 4102
M20 x 2	0141 120 5104	–	0141 520 5102
M22	0141 122 0104	–	0141 522 0102
M22 x 1.5	0141 122 4104	0141 422 4152	0141 522 4102
M22 x 2	0141 122 5104	–	0141 522 5102
M24	0141 124 0104	–	0141 524 0102
M24 x 1.5	0141 124 4104	0141 424 4152	0141 524 4102
M24 x 2	0141 124 5104	–	0141 524 5102
M26 x 1.5	0141 126 4104	0141 426 4152	0141 526 4102
M27	0141 127 0104	–	0141 527 0102
M27 x 1.5	0141 127 4104	0141 427 4152	0141 527 4102
M27 x 2	0141 127 5104	–	0141 527 5102
M28 x 1.5	0141 128 4104	0141 428 4152	0141 528 4102
M30	0141 130 0104	–	0141 530 0102
M30 x 1.5	0141 130 4104	0141 430 4152	0141 530 4102
M30 x 2	0141 130 5104	–	0141 530 5102
M33	0141 133 0104	–	0141 533 0102
M33 x 2	0141 133 5104	–	0141 533 5102
M36	0141 136 0104	–	0141 536 0102
M36 x 1.5	0141 136 4104	0141 436 4152	–
M36 x 2	0141 136 5104	–	0141 536 5102
M36 x 3	0141 136 6104	–	0141 536 6102

* For tolerance class 4H, the ninth digit of the order No changes from 1 to 2. For details see page 35. For HELICOIL® special taps for specific applications and materials, see page 37.

** 1 N/mm² equals 1 MPa.

Machine taps for **HELICOIL® Plus**

Nominal thread Ø d	Version	Min. out-side Ø D _{HC}	Shank Ø h 9 d 2	Chamfer Ø d 3	Total length L 1	Types 0141.1 / 0141.4 Max. thread length L 2	Type 0141.5 Max. thread length L 2	Square length L 3	Square H 12 K	L 4	d 4
M2	A	2.5	2.8	2	50	8	4	5	2.1	–	–
M2.5	B	3.1	3.5	2.5	56	11	5	6	2.7	18	2.6
M3	B	3.7	4	3	56	13	6	6	3.0	20	3.1
M3.5	B	4.3	4.5	3.5	63	13	7	6	3.1	21	3.6
M4	B	4.9	6	4	70	16	8	8	4.9	25	4.2
M5	B	6.0	6	5	80	17	10	8	4.9	30	5.2
M6	B	7.3	8	6	90	20	12	9	6.2	35	6.2
M7	B	8.3	9	7	90	20	12	10	7	35	7.2
M8	B	9.6	10	8	100	20	14	11	8	39	8.3
M8 x 1	B	9.3	9	8	90	20	12	10	7	35	8.2
M9	C	10.6	8	9	100	22	14	9	6.2	–	–
M10	C	12.0	9	10	110	24/16	16	10	7	–	–
M10 x 1	C	11.3	9	10	100	22	16	10	7	–	–
M10 x 1.25	C	11.6	9	10	100	22	16	10	7	–	–
M11	C	13.0	11	11	100	22/20	20	11	9	–	–
M12	C	14.3	11	12	110	26/20	20	12	9	–	–
M12 x 1	C	13.3	11	12	100	22/20	20	12	9	–	–
M12 x 1.25	C	13.6	11	12	100	22/20	20	12	9	–	–
M12 x 1.5	C	14.0	11	12	100	22/20	20	12	9	–	–
M14	C	16.6	12	14	110	28/20	20	12	9	–	–
M14 x 1	C	15.3	12	14	100	22/20	20	12	9	–	–
M14 x 1.25	C	15.6	12	14	100	22/20	20	12	9	–	–
M14 x 1.5	C	16.0	12	14	100	22/20	20	12	9	–	–
M16	C	18.6	14	16	125	34/25	25	14	11	–	–
M16 x 1.5	C	18.0	14	16	110	25	25	14	11	–	–
M18	C	21.3	16	18	140	34/25	25	15	12	–	–
M18 x 1.5	C	20.0	16	18	125	25	25	15	12	–	–
M18 x 2	C	20.6	16	18	140	34	25	15	12	–	–
M20	C	23.3	18	20	140	34/25	25	17	14.5	–	–
M20 x 1.5	C	22.0	18	20	125	25	25	17	14.5	–	–
M20 x 2	C	22.6	18	20	140	34	25	17	14.5	–	–
M22	C	25.3	18	22	160	38/30	30	17	14.5	–	–
M22 x 1.5	C	24.0	18	22	140	28	28	17	14.5	–	–
M22 x 2	C	24.6	18	22	140	28	28	17	14.5	–	–
M24	C	27.9	20	24	160	38/30	30	19	16	–	–
M24 x 1.5	C	26.0	18	24	140	28	28	17	14.5	–	–
M24 x 2	C	26.6	20	24	140	28	28	19	16	–	–
M26 x 1.5	C	28.0	20	26	140	28	28	19	16	–	–
M27	C	30.9	22	27	180	50	50	21	18	–	–
M27 x 1.5	C	29.0	22	27	150	28	28	21	18	–	–
M27 x 2	C	29.6	22	27	150	28	28	21	18	–	–
M28 x 1.5	C	30.0	22	28	150	28	28	21	18	–	–
M30	C	34.5	28	30	200	56	56	25	22	–	–
M30 x 1.5	C	32.0	22	30	150	28	28	21	18	–	–
M30 x 2	C	32.6	25	30	160	30	28	23	20	–	–
M33	C	37.5	28	33	200	56	56	25	22	–	–
M33 x 2	C	35.6	28	33	170	30	30	25	22	–	–
M36	C	41.2	32	36	200	60	60	27	24	–	–
M36 x 1.5	C	38.0	28	36	170	30	30	25	22	–	–
M36 x 2	C	38.6	32	36	170	30	30	27	24	–	–
M36 x 3	C	39.9	32	36	200	60	60	27	24	–	–

Further sizes on request.

Combined drilling and tapping tools



For tapping HELICOIL® holding threads in damaged, stripped metric coarse and fine threads.

The HELICOIL® holding thread (tap hole) does not need to be pre-drilled. With its guide part $d_3 \times L_5$, it can only be used for blind-hole threads under certain conditions.

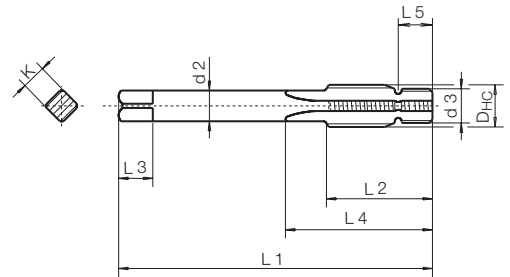

Nominal thread Ø d	Order No	Min. outside Ø D _{HC}	Shank Ø h 9 d 2	Chamfer Ø d 3	Total length L 1	Max. thread length L 2	Square length L 3	L 4 min.	guide thread length L 5	Square H 12 K
M6	0142 006 0102	7.3	8	M6	90	90	9	36	6	6.2
M8	0142 008 0102	9.7	10	M8	90	90	11	38	7.5	8
M10	0142 010 0102	12.0	12	M10	100	100	12	42	9	9
M10 x 1	0142 910 3450	11.3	9	M10 x 1	92	92	10	42	9	7
M12	0142 912 0450	14.3	11	M12	92	92	12	43	10	9
M12 x 1.25	0142 912 9450	13.7	11	M12 x 1.25	92	92	12	43	10	9
M12 x 1.5	0142 912 4450	13.7	11	M12 x 1.25	92	92	12	43	10	9
M14	0142 914 0450	13.7	11	M12 x 1.25	92	92	12	43	10	9
M14 x 1.25	0142 914 9450	15.7	11	M14 x 1.25	92	92	12	43	10	9
M14 x 1.25	0142 014 9102	15.7	11	M14 x 1.25	153	153	12	43	10	9
M14 x 1.5	0142 914 4450	16.0	11	M14 x 1.5	92	92	12	43	10	9
M16	0142 916 0450	18.7	14	M16	90	90	14	50	9	11
M16 x 1.5	0142 916 4450	18.0	14	M16 x 1.5	92	92	14	50	10	11

Machine forming taps for **HELICOIL® Plus**



Chipless production of internal threads for blind-hole and through-hole threads

- With lubrication grooves
- Immaculate lubrication even for large depths
- Cutting speeds are the same as for tapping

Lubrication:

Oil-containing lubricants or grease-containing emulsions.

Material range:

Very ductile materials, such as aluminium, copper or zinc alloys, steel with a strength of up to 700 N/mm²*, soft stainless steels.

For materials with a minimum elongation at break of 10 %.

Version B

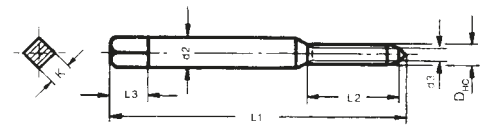

Version C

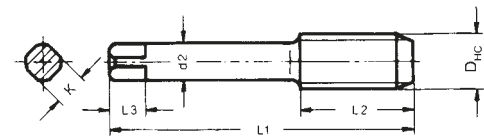

Nominal thread Ø d	Guide value for shaped hole Ø d _F	Order No ①	Version	Min. outside Ø D _{HC}	Shank Ø h 9 d 2	Total length L 1	Max. thread length L 2	Square length L 3	Square H 12 K	L 4	d 4
M3	3.4	0144 103 0004	B	3.69	4	56	13	6	2.7	20	3.1
M3.5	4.0	0144 135 0004	B	4.33	4.5	63	13	6	3.1	21	3.6
M4	4.6	0144 104 0004	B	4.96	6	70	16	8	4.9	25	4.2
M5	5.6	0144 105 0004	B	6.09	6	80	17	8	4.7	30	5.2
M6	6.8	0144 106 0004	B	7.37	8	90	20	9	6.2	35	7.2
M8	9.0	0144 108 0004	B	9.69	10	100	20	11	8	39	8.9
M10	11.2	0144 110 0004	C	12.02	9	110	24	10	7	–	–
M12	13.4	0144 112 0004	C	14.37	11	110	26	12	9	–	–

Further sizes on request.

We also offer TiN-coated forming taps.

① For tolerance class 4H, the ninth digit of the designation changes from 0 to 2.

For details see **page 35**.

* 1 N/mm² equals 1 MPa.

Thread plug gauges for **HELICOIL® Plus** holding threads



To check the trueness to gauge of holding threads produced with a threading tool, we offer the following thread plug gauges:

Nominal thread Ø d	Thread pitch P	Tolerance class 6H mod or 5H Order No	Tolerance class 5H mod or 4H Order No
M2	0.4	0147 302 0500	0147 302 0400
M2.5	0.45	0147 325 0500	0147 325 0400
M3	0.5	0147 303 0500	0147 303 0400
M3.5	0.6	0147 335 0500	0147 335 0400
M4	0.7	0147 304 0500	0147 304 0400
M5	0.8	0147 305 0500	0147 305 0400
M6	1	0147 306 0500	0147 306 0400
M7	1	0147 307 0500	0147 307 0400
M8	1.25	0147 308 0500	0147 308 0400
M8 x 1	1	0147 308 3500	0147 308 3400
M9	1.25	0147 309 0500	0147 309 0400
M10	1.5	0147 310 0500	0147 310 0400
M10 x 1	1	0147 310 3500	0147 310 3400
M10 x 1.25	1.25	0147 310 9500	0147 310 9400
M11	1.5	0147 311 0500	0147 311 0400
M12	1.75	0147 312 0500	0147 312 0400
M12 x 1	1	0147 312 3500	0147 312 3400
M12 x 1.25	1.25	0147 312 9500	0147 312 9400
M12 x 1.5	1.5	0147 312 4500	0147 312 4400
M14	2	0147 314 0500	0147 314 0400
M14 x 1	1	0147 314 3500	0147 314 3400
M14 x 1.25	1.25	0147 314 9500	0147 314 9400
M14 x 1.5	1.5	0147 314 4500	0147 314 4400
M16	2	0147 316 0500	0147 316 0400
M16 x 1.5	1.5	0147 316 4500	0147 316 4400
M18	2.5	0147 318 0500	0147 318 0400
M18 x 1.5	1.5	0147 318 4500	0147 318 4400
M18 x 2	2	0147 318 5500	0147 318 5400
M20	2.5	0147 320 0500	0147 320 0400
M20 x 1.5	1.5	0147 320 4500	0147 320 4400
M20 x 2	2	0147 320 5500	0147 320 5400
M22	2.5	0147 322 0500	0147 322 0400
M22 x 1.5	1.5	0147 322 4500	0147 322 4400
M22 x 2	2	0147 322 5500	0147 322 5400
M24	3	0147 324 0500	0147 324 0400
M24 x 1.5	1.5	0147 324 4500	0147 324 4400
M24 x 2	2	0147 324 5500	0147 324 5400
M26 x 1.5	1.5	0147 326 4500	0147 326 4400
M27	3	0147 327 0500	0147 327 0400
M27 x 1.5	1.5	0147 327 4500	0147 327 4400
M27 x 2	2	0147 327 5500	0147 327 5400
M28 x 1.5	1.5	0147 328 4500	0147 328 4400
M30	3.5	0147 330 0500	0147 330 0400
M30 x 1.5	1.5	0147 330 4500	0147 330 4400
M30 x 2	2	0147 330 5500	0147 330 5400
M33	3.5	0147 333 0500	0147 333 0400
M33 x 2	2	0147 333 5500	0147 333 5400
M36	4	0147 336 0500	0147 336 0400
M36 x 1.5	1.5	0147 336 4500	0147 336 4400
M36 x 2	2	0147 336 5500	0147 336 5400
M36 x 3	3	0147 336 6500	0147 336 6400

A calibration certificate will be provided on request: Item code 0147 999 9001

Further sizes on request.

Thread tolerances: For details see **page 35**.



To allow the user to check the correct installation more easily, the HELICOIL® system solution was expanded with this efficient depth gauge.

Due to user-friendly handling, the process times for measurement and recording of the installation depth can be reduced. Beyond calibrated measured values — installation depth incl. tolerances — the precise gauge allows the user to check if there is a HELICOIL® thread insert installed. There are no cost-intensive process steps.

The device has a compact design and can be operated without specialised knowledge.

Your advantages at a glance:

- Precise measurement and detection of installed HELICOIL® thread inserts
- Easy handling
- Compact design
- Detailed documentation incl. certificate

Delivery scope:

Each HELICOIL® depth gauge is supplied in a protective case with individual design and labelling. It is shock-resistant, watertight and dustproof and comes with all required documents/certificates.

This ensures the durability of the product during its continued use in a great number of different environments.



Technical data of the HELICOIL® depth gauge kit

Available sizes	Order No
10-32 UNF	A71652035500
1/4"-28 UNF	A71652035600
5/16"-24 UNF	A71652035700
3/8"-24 UNF	A71652035800
7/16"-20 UNF	A71652035900
1/2"-20 UNF	A71652036000

Further sizes on request. Please do not hesitate to contact us.

HELICOIL® Plus installation process



Overview of the processing variants	48
Installation mandrel	50
Installation tools	52
Cordless installation tools	52
Electrical installation tools	53
Pneumatic installation tools	58
Accessories	64
Manual installation tools	65
Tang break-off tools and extraction tools	66
Efficient repair solutions	67

HELICOIL® system modules — overview of the processing variants

Basically, there are three types of installation tools. The installation tools are chosen according to the volume of HELICOIL® Plus thread inserts to process, the location of the tapped holes in the workpiece and the thread size. There are the following types:

- Manual installation tools
- Pneumatic installation tools
- Electrical installation tools
- Electrical installation tools with battery power

Manual installation tools

Manual installation tools with leader cartridge

Type H-PSG 0150 01

M2 to M36

Threaded mandrel, pitch-controlled with depth stop

Page 65



Type H-PMG

Leader cartridge, smooth mandrel, pitch-controlled with depth stop on request

Page 65



Type H-PM

Leader cartridge, smooth mandrel, without pitch control, with depth stop on request

Page 65



Fly-over tool

Type H-M 0150 07

M18 to M36

with depth stop

Page 65



Pneumatic installation tools

Installation mandrel*

Types 4160 and 5160

Page 51



P-S 412

M4 to M12

Page 58



P-S 1216

M12 to M16

Page 58



Leader cartridge

Type 0160

Page 61



P-PSG 256

M2.5 to M6

Page 60



P-PSG 714

M7 to M14

P-PSG 1626

M16 to M26

Page 62



* Illustration of the installation mandrel exemplary. For the respective installation mandrels, see pages 50–51.

Electrical installation tools

HELICOIL® E-PSG

Quick Exchange

Page 56



HELICOIL® E-PSG

Process-Controlled

Page 54



Installation mandrel*



Leader cartridge

Type 0160

Page 61



Type E-S 206

M2 to M6

Page 53



Type E-PSG 256

M2.5 to M6

Page 53



Type E-S 410/Type E-S 1216

M4 to M 10 M12 to M16

Page 53



Type E-PSG 714

M7 to M14

Page 53



Battery installation tools

Installation mandrel*



Battery power pack

Installation tool

Type B-S 206

M2 to M6

Page 52



Battery power pack

Installation tool

Type B-S 824

M7 to M24

Page 52



* Illustration of the installation mandrel exemplary. For the respective installation mandrels, see pages 50–51.

HELICOIL® Plus installation mandrel

The HELICOIL® Plus installation mandrels can be used with the following tools:

- Electrical installation tools types E-S 206, E-S 410 and E-S 1216
- Cordless installation tools types B-S 206 and B-S 824
- Pneumatic installation tools P-S 412 and P-S 1216

Your advantages

- Quick retooling
- Reduced tool costs
- Sizes M2 to M24
- Pick-and-place processing possible

Installation mandrel with depth stop

Only suited for the installation of HELICOIL® Plus Free Running and Screwlock.
With external hexagon DIN 3126 — E 6.3/DIN ISO 1173.

For installation tools types B-S 206, E-S 206, E-S 410, P-S 412

Nominal thread Ø	Mandrel Free Running Order No	Mandrel Screwlock Order No	L ₁	L ₂ max.	L	D ₁	D ₂ Ø _{h9}	Design
M2	4160 2302 020	4160 2302 022	25	9	9	8	8	1
M2.5	4160 2325 020	4160 2325 022	25	9	9	8	8	1
M3	4160 2303 020	4160 2303 022	30	14	14	8	8	1
M3.5	4160 2335 020	4160 2335 022	30	14	14	8	8	1
M4	4160 2304 020	4160 2304 022	35	16	16	8	8	1
M5	4160 2305 020	4160 2305 022	40	20	20	10	10	1
M6	4160 2306 020	4160 2306 022	40	20	20	11	11	1

Type 4160.23

(design 1)

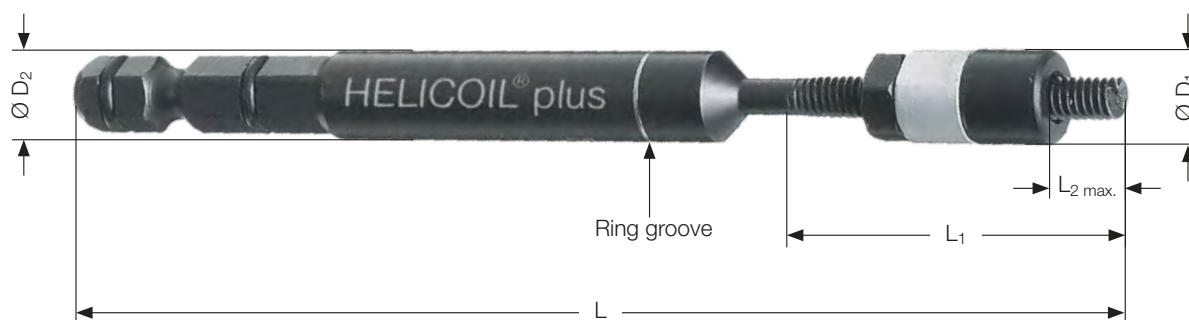

HELICOIL® Plus installation mandrel

Type 4160.25
(design 2)



For installation tools types B-S 824, E-S 410, E-S 1216, P-S 412 and P-S 1216

Nominal thread Ø	Mandrel Free Running Order No	Mandrel Screwlock Order No	L ₁	L ₂ max.	L	D ₁	D ₂ Ø _{h9}	Design
M7	4160 2507 020	4160 2507 022	55	30	105	13	8	2
M8	4160 2508 020	4160 2508 022	55	30	105	15	8	2
M9	4160 2509 020	4160 2509 022	65	40	110	15	8	2
M10	4160 2510 020	4160 2510 022	60	40	110	16	8	2
M12	4160 2512 020	4160 2512 022	70	45	115	20	8	2
M12 x 1.5	4160 2512 420	4160 2512 422	65	45	115	20	8	2
M14	4160 2514 020	4160 2514 022	70	50	120	21	8	2
M14 x 1.5	4160 2514 420	4160 2514 422	70	50	120	21	8	2
M16	4160 2516 020	4160 2516 022	80	55	135	24	8	2
M16 x 1.5	4160 2516 420	4160 2516 422	80	55	135	24	8	2
M18	4160 2518 020	4160 2518 022	90	65	135	30	8	2
M20	4160 2520 020	4160 2520 022	100	70	145	31	8	2
M22	4160 2522 020	4160 2522 022	110	80	155	33	8	2
M24	4160 2524 020	4160 2524 022	120	90	165	35	8	2

Adapted tools for Inconel X 750, Nimonic 90 and aluminium inserts on request.



These installation mandrels can also be used as manual installation mandrels.

HELICOIL® Plus Screwlock installation mandrels are marked with a ring groove on the guide shaft.
HELICOIL® Free Running installation mandrels have a smooth guide shaft.

Cordless installation tools for **HELICOIL® Plus**

Battery power pack installation tool type B-S 206

For processing HELICOIL® Plus thread inserts M2 to M6 using the respective HELICOIL® Plus installation mandrel



Delivery scope:

- Cordless straight gun screwdriver (bendable)
- 2 pieces battery pack 3.6 V, 1.5 Ah
- Quick charger
- Case

Technical data:

Idle speed:	two-speed 200 rpm and 600 rpm, reversible
Torque:	adjustable in 21 steps 0.3–2.9 Nm/4.4 Nm max.
Tool holder:	1/4" hexagon socket
Weight incl. battery:	0.5 kg
Battery:	3.6 V/1.5 Ah/charging time 30 min
Order No:	4160 430 0000

Spare parts and accessories:

Spare battery:	Order No 4160 430 0200
Quick charger:	Order No 4160 430 0300

Battery power pack installation tool type B-S 824

For processing HELICOIL® Plus thread inserts M7 to M24 using the respective HELICOIL® Plus installation mandrel



Delivery scope:

- Cordless gun screwdriver
- 2 pieces battery pack 15.6 V, 3 Ah
- Quick charger
- Case

Technical data:

Idle speed:	speed 1/stepless 65–450 rpm, reversible speed 2/stepless 200–1450 rpm, reversible
Torque:	adjustable in 19 steps 1–6.9 Nm/31.9 Nm max.
Tool holder:	three-jaw chuck 1.0–13 mm
Weight incl. battery:	2.0 kg
Battery:	15.6 V/3 Ah/charging time 45 min
Order No:	4160 350 0000

Spare parts and accessories:

Spare battery:	Order No 4160 350 0200
Quick charger:	Order No 4160 350 0300

Electrical installation tools for **HELICOIL® Plus**



i The installation mandrels for all available sizes are provided on **pages 50/51**.

Type E-S 206

For the quick processing of HELICOIL® Plus thread inserts M2 to M6 using the respective HELICOIL® Plus installation mandrel

Delivery scope:

- Straight screwdriver with 1/4" hexagon
- Power supply for two screwdrivers
- Case

Technical data:

Idle speed: 720 rpm
 Output voltage: 35 V DC
 Torque: M = 0.45–0.95 Nm
 Steplessly adjustable shut-off clutch
 Tool holder: 1/4" hexagon socket with radial bearing
 Weight: 0.31 kg
 Order No: **4160 220 0000**

Type E-S 410 / type E-S 1216

For the quick processing of HELICOIL® Plus thread inserts M4 to M10 / M12 to M16 with the respective HELICOIL® Plus installation mandrels



i The installation mandrels for all available sizes are provided on **pages 50/51**.

Delivery scope per device:

- Straight screwdriver with quick-change chuck 1/4" hexagon socket
- Speed adjustable through ramp control on the control unit, type EDU 2AE
- Case

Technical data:

	Type E-S 410	Type E-S 1216
Idle speed:	1.200 rpm	200–850 rpm
	Steplessly adjustable. Automatic reversal of the direction of rotation when the screw-in depth is reached	
Torque:	0.9 to 3 Nm	0.5 to 6 Nm
	Torque steplessly adjustable at the control unit	
Tool holder:	quick-change chuck 1/4" hexagon socket with radial bearing for installation mandrel	
Weight:	0.57 kg	0.6 kg
Order No:	4160 540 0000	4160580000

Type E-PSG 256 with leader cartridge

For the quick processing of HELICOIL® Plus thread inserts M2.5 to M6 using the HELICOIL® Plus exchange unit



i The exchange units for all available sizes are provided on **pages 61 and 63**.

Delivery scope: See type E-S 410.

Technical data:

Idle speed: 1,200 rpm (steplessly adjustable)
 automatic reversal of the direction of rotation when the screw-in depth is reached
 Torque: 0.9 to 3 Nm
 Torque steplessly adjustable at the control unit
 Tool holder: Connection for leader cartridges of P-PSG 256
 Weight: 0.75 kg
 Order No: **0160 470 0000**



HELICOIL® E-PSG Process-Controlled



Fast installation of HELICOIL® thread inserts with high process reliability

The new E-PSG Process-Controlled electrical installation tool is used to install HELICOIL® Classic and HELICOIL® Plus thread inserts in a monitored process.

During the entire installation process, sensors on the nose-piece monitor the correct positioning of the tool relative to the component. This ensures the accurate installation of the HELICOIL® thread insert.

Moreover does the rotation angle- and torque-controlled installation allow the precise insertion depth for the HELICOIL®.

Benefit from a documented accurate installation and thus reduce production times.

The advantages at a glance:

- Monitoring of the entire installation process
- Automatic identification of non-conforming installations
- Documentation of correct and incorrect installation processes
- Positioning accuracy for the HELICOIL® ranging between 0.25 and 2 x P below the surface
- Rotation angle and torque monitoring
- Easy connection to a robot

Technical data:

- Length: 370 mm
- Diameter: 52 mm
- Weight: 970 g
- Size range: M6*
- Steplessly adjustable speed between 350 and 850 rpm
- Steplessly adjustable torque between 0.6 and 6 Nm
- Special exchange units and mandrels

Delivery scope:

The following is included in the handy transport case for protection and safe long-term storage:

- E-PSG PC M6 installation tool incl. exchange unit
- Control unit
- Power cord
- Connecting line
- Mount for parallel system
- Function checking tool for contact sensors
- Two open-end wrenches
- Technical documentation GER/EN



* Further sizes on request.



HELICOIL® E-PSG 256 Quick Exchange

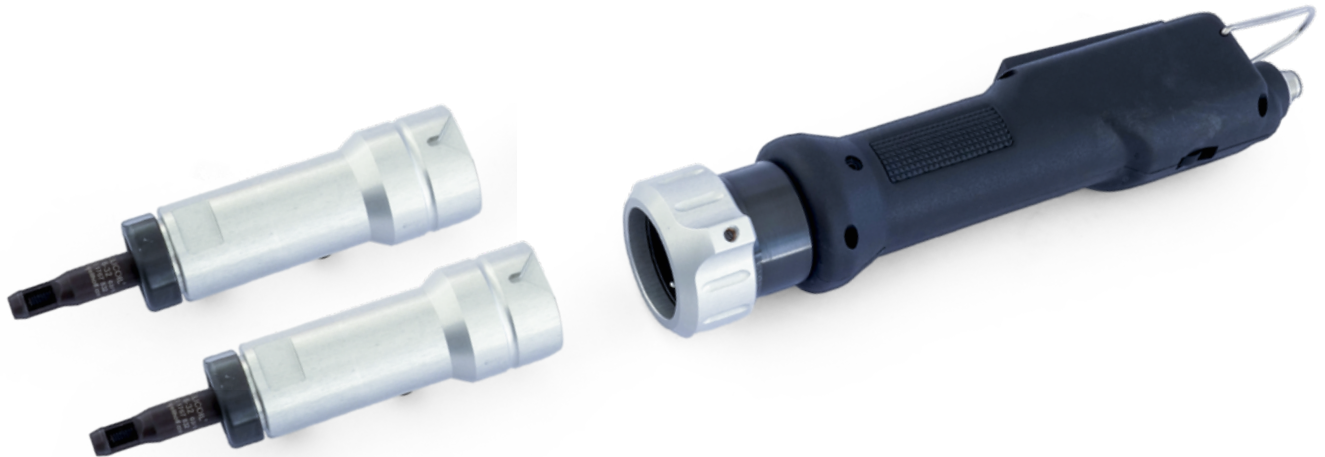

Quick change of different sizes without loss of performance

These new electrical installation tools are used to very reliably install HELICOIL® Classic, HELICOIL® Tangfree and HELICOIL® Plus thread inserts. The HELICOIL® E-PSG 256 Quick Exchange is a perfect solution which stands for a long tool life, process reliability and short installation times.

Benefit from those advantages, particularly for medium and large series.

The advantages at a glance:

Quick change of exchange units for different HELICOIL® types, sizes and lengths:

- Time-saving
- Brushless motor for cleanroom applications
- Small and transportable tool
- Stepless adjustment: speed/torque
- Easy control of spinning on and off

The HELICOIL® E-PSG 256 Quick Exchange tool is supplied with a process control which guarantees the reliable installation of HELICOIL® once the recommended parameters have been set up.

An LED (red/green) indicates whether the installation has been correct or whether it failed.

- Optimised software for HELICOIL®
- Automatic switchover upon reaching the insertion depth
- Stepless adjustment: speed/torque
- With the brushless motor, the tool is perfectly suited for cleanroom applications
- Manual switchover possible (fault clearance)
- Presetting of up to eight different programs
- Display program names and sequences can be set individually
- Built-in piece counter

Complete installation tool

The complete installation tool is available with item number 0160 870 0000.

Delivery scope:

- EDU2AE/TOP/E control unit
- Electric motor type Pluto 3 including the Quick Exchange system
- BitBox without size-specific adapters
- 4 x basic tool*
- Cables and wrench
- Plastic case with foam padding
- Operating instructions

* If more than four HELICOIL® sizes are required, please order another basic tool for each additional size (item number: 0160 870 0040).



Pneumatic installation tools for **HELICOIL® Plus**

Pneumatic installation tool type P-S 412

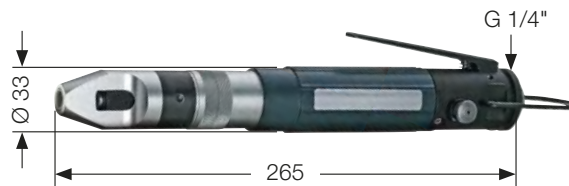

For the quick processing of HELICOIL® Plus thread inserts M4 to M12 using the respective HELICOIL® Plus installation mandrel

Technical data:

Idle speed:	1,500 rpm at p = 6.3 bar adjustable via air pressure
Air consumption:	5.5 l/s at p = 6.3 bar
Torque:	M = 1.2–4.5 Nm steplessly adjustable shut-off clutch
Tool holder:	1/4" hexagon socket with radial bearing
Weight:	0.8 kg
Order No:	4160 270 0010

Pneumatic installation tool type P-S 1216

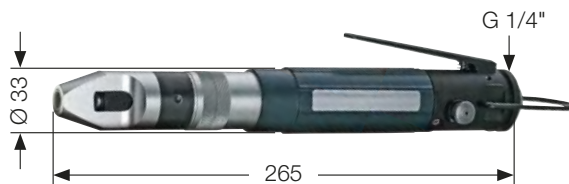

For the quick processing of HELICOIL® Plus thread inserts M12 to M16 using the respective HELICOIL® Plus installation mandrel

Technical data:

Idle speed:	950 rpm at p = 6.3 bar adjustable via air pressure
Air consumption:	5.5 l/s at p = 6.3 bar
Torque:	M = 1.2–5.5 Nm steplessly adjustable shut-off clutch
Tool holder:	1/4" hexagon socket with radial bearing
Weight:	0.8 kg
Order No:	4160 180 0010



Size-specific HELICOIL® Plus installation mandrels with depth stop must be ordered separately, **see pages 50/51.**

Pneumatic installation tools for **HELICOIL® Plus**

Spare handle for P-S 1216

Handle for the safe compensation of the installation torque for sizes \geq M12

Order No: **4160 180 0006**



Suspension bracket for P-S 412 and P-S 1216

for the horizontal suspension of the tools on balancer systems

Order No: **4160 180 0007**



Pneumatic installation tool with leader cartridge
type P-PSG for **HELICOIL®**

For HELICOIL® Classic as well as HELICOIL® Plus
Free Running and Screwlock

Pitch-controlled HELICOIL® Classic and HELICOIL® Plus installation tool for **bulk material processing**.
The installation tool is equipped with a reversible compressed-air motor and a size-specific exchange unit.
The HELICOIL® installation depth is adjusted with compensation washers.
We recommend this tool for medium- and large-scale series.

Complete tool

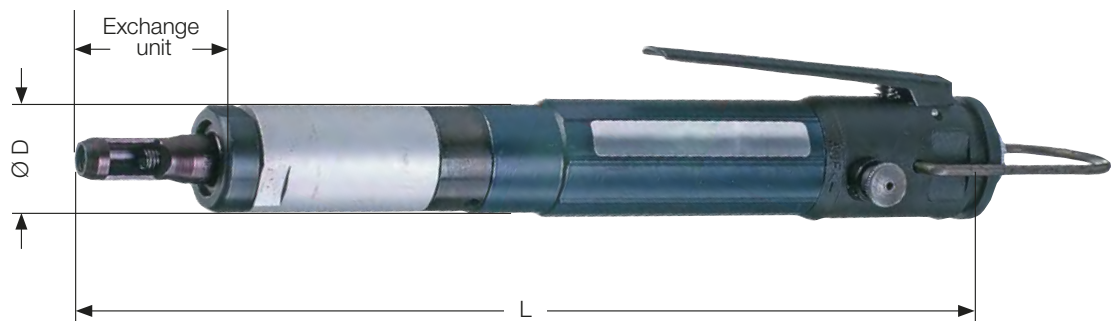

Type***	Nominal thread Ø d	Complete tool Order No	Structural dimensions		Weight kg	Connection bar	Air consumption** l/min
			Ø D	L			
P-PSG 256	M2.5	0160 372 5000	28	240	0.6	2.5-4.0	204
	M3	0160 370 3000	28	240	0.6	2.5-4.0	204
	M4	0160 370 4000	28	240	0.6	2.5-4.0	204
	M5	0160 370 5000	28	240	0.6	2.5-4.0	204
	M6	0160 370 6000	28	240	0.6	2.5-4.0	204
P-PSG 714	M7	0160 280 7000	42	360	1.4	4.0-5.0	282
	M8	0160 280 8000	42	360	1.4	4.0-5.0	282
	M8 x 1	0160 280 8300	42	360	1.4	4.0-5.0	282
	M10	0160 281 0000	42	360	1.4	4.0-5.0	282
	M10 x 1.25	0160 281 0900	42	360	1.4	4.0-5.0	282
	M10 x 1	0160 281 0300	42	360	1.4	4.0-5.0	282
	M12	0160 281 2000	42	360	1.4	4.0-5.0	282
	M12 x 1.5	0160 281 2400	42	360	1.4	4.0-5.0	282
	M12 x 1.25	0160 281 2900	42	360	1.4	4.0-5.0	282
	M12 x 1	0160 281 2300	42	360	1.4	4.0-5.0	282
	M14*	0160 281 4000	42	360	1.4	4.0-5.0	282
	M14 x 1.5	0160 281 4400	42	360	1.4	4.0-5.0	282
M14 x 1.25	0160 281 4900	42	360	1.4	4.0-5.0	282	
P-PSG 1626	M16	0160 191 6000	42	440	2.5	4.0-6.0	282
	M16 x 1.5	0160 191 6400	42	440	2.5	4.0-6.0	282
	M18 x 1.5	0160 191 8400	42	440	2.5	4.0-6.0	282
	M20	0160 192 0000	42	440	2.5	4.0-6.0	282
	M20 x 1.5	0160 192 0400	42	440	2.5	4.0-6.0	282
	M22 x 1.5	0160 192 2400	42	440	2.5	4.0-6.0	282
	M24 x 1.5*	0160 192 4400	42	440	2.5	4.0-6.0	282
M26 x 1.5*	0160 192 6400	42	440	2.5	4.0-6.0	282	

Important order information:

When you order tools, specify type, size and length of the HELICOIL® Plus thread inserts to process. Tools for the installation of HELICOIL® Plus thread inserts with lengths > 2.5 d on request. As required by the German accident prevention regulations (UVV), types P-PSG 714 and P-PSG 1626 are equipped with a sliding sleeve for finger protection. This finger protection must not be removed. The installation tools are equipped with Bosch motors.

* Basic tool with stronger motor.

** Air consumption at 6.3 bar. (See page 58.)

*** Exchange units can be interchanged within the individual series.

Adapted tools for Inconel X 750, Nimonic 90 and aluminium inserts on request.



Exchange unit — nosepiece



Basic tool



Motor

Assemblies

Type***	Nominal thread Ø d	Exchange unit Order No	Basic tool Order No	Motor Order No
P-PSG 256	M3	0160 270 3050	0160 370 0040	0160 370 0010
	M4	0160 270 4050		
	M5	0160 270 5050		
	M6	0160 270 6050		
P-PSG 714	M7	0160 280 7050	0160 180 0040	0160 180 0010
	M8	0160 280 8050		
	M8 x 1	0160 280 8350		
	M10	0160 281 0050		
	M10 x 1.25	0160 281 0950		
	M10 x 1	0160 281 0350		
	M12	0160 281 2050		
	M12 x 1.5	0160 281 2450		
	M12 x 1.25	0160 281 2950		
	M12 x 1	0160 281 2350		
	M14*	0160 281 4050		0160 090 0011
	M14 x 1.5	0160 281 4450		0160 180 0010
P-PSG 1626	M14 x 1.25	0160 281 4950	0160 090 0040	0160 090 0011
	M16	0160 191 6050		
	M16 x 1.5	0160 191 6450		
	M18 x 1.5	0160 191 8450		
	M20	0160 192 0050		
	M20 x 1.5	0160 192 0450		
	M22 x 1.5	0160 192 2450		
	M24 x 1.5*	0160 192 4450		
M26 x 1.5*	0160 192 6450			

Wear and spare parts — exchange unit



Leader cartridge



Installation mandrel



Coupling for installation mandrel



Range of compensation washers

Type***	Nominal thread Ø d	Leader cartridge Order No	Installation mandrel Order No	Coupling for installation mandrel Order No	Range of compensation washers Order No
P-PSG 256	M2.5	0160 172 5032	0160 372 5020	0160 170 0006	0160 170 0060
	M3	0160 170 3032	0160 270 3020		
	M4	0160 170 4032	0160 270 4020		
	M5	0160 170 5032	0160 270 5020		
	M6	0160 170 6032	0160 270 6020		
P-PSG 714	M7	0160 280 7032	0160 280 7020	0160 180 0006	0160 280 0060
	M8	0160 280 8032	0160 280 8020		
	M8 x 1	0160 280 8332	0160 280 8320		
	M10	0160 281 0032	0160 281 0020		
	M10 x 1.25	0160 281 0932	0160 281 0920		
	M10 x 1	0160 281 0332	0160 281 0320		
	M12	0160 281 2032	0160 281 2020		
	M12 x 1.5	0160 281 2432	0160 281 2420		
	M12 x 1.25	0160 281 2932	0160 281 2920		
	M12 x 1	0160 281 2332	0160 281 2320		
	M14*	0160 281 4032	0160 281 4020		
	M14 x 1.5	0160 281 4432	0160 281 4420		
M14 x 1.25	0160 281 4932	0160 281 4920			
P-PSG 1626	M16	0160 191 6032	0160 191 6020	0160 180 0006	0160 190 0060
	M16 x 1.5	0160 191 6432	0160 191 6420		
	M18 x 1.5	0160 191 8432	0160 191 8420		
	M20	0160 192 0032	0160 192 0020		
	M20 x 1.5	0160 192 0432	0160 192 0420		
	M22 x 1.5	0160 192 2432	0160 192 2420		
	M24 x 1.5*	0160 192 4432	0160 192 4420		
	M26 x 1.5*	0160 192 6432	0160 192 6420		

Pneumatic installation tool with leader cartridge type P-PSG for **HELICOIL® STRIPFEED®**

For HELICOIL® Classic STRIPFEED® and
HELICOIL® Plus STRIPFEED®

Pitch-controlled HELICOIL® Classic and HELICOIL® Plus installation tool for processing **collated thread inserts**.

The installation tool is equipped with a reversible compressed-air motor and a size-specific exchange unit.

The HELICOIL® installation depth is adjusted with compensation washers.

We recommend this tool for medium- and large-scale series.

Complete tool

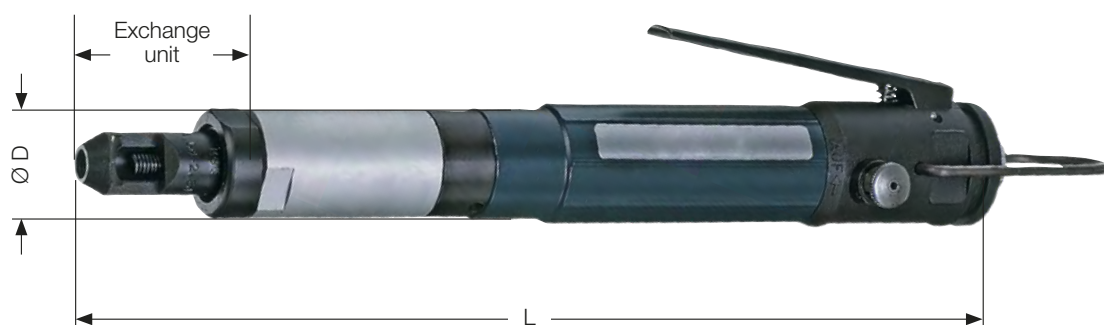

Type**	Nominal thread Ø d	Complete tool Order No	Max. length	Structural dimensions		Weight kg	Connection bar	Air consumption* l/min
				Ø D	L			
P-PSG 256 SF	M2.5	0160 372 5002	≤ 1.25 d	28	240	0.6	2.5–4.0	204
	M2.5	0160 372 5003	1.5–2.5 d	28	240	0.6	2.5–4.0	204
	M3	0160 370 3002	≤ 1.25 d	28	240	0.6	2.5–4.0	204
	M3	0160 370 3003	1.5–2.5 d	28	240	0.6	2.5–4.0	204
	M4	0160 370 4002	≤ 1.25 d	28	240	0.6	2.5–4.0	204
	M4	0160 370 4003	1.5–2.5 d	28	240	0.6	2.5–4.0	204
	M5	0160 370 5002	≤ 1.25 d	28	240	0.6	2.5–4.0	204
	M5	0160 370 5003	1.5–2.5 d	28	240	0.6	2.5–4.0	204
	M6	0160 370 6002	≤ 1.25 d	28	240	0.6	2.5–4.0	204
	M6	0160 370 6003	1.5–2.5 d	28	240	0.6	2.5–4.0	204
P-PSG 714 SF	M7	0160 280 7002	≤ 1.25 d	42	360	1.4	4.0–5.0	282
	M7	0160 280 7003	1.5–2.5 d	42	360	1.4	4.0–5.0	282
	M8	0160 280 8002	≤ 1.25 d	42	360	1.4	4.0–5.0	282
	M8	0160 280 8003	1.5–2.5 d	42	360	1.4	4.0–5.0	282
	M10	0160 281 0002	≤ 1.25 d	42	360	1.4	4.0–5.0	282
	M10	0160 281 0003	1.5–2.5 d	42	360	1.4	4.0–5.0	282

Important order information:

When you order tools, specify type, size and length of the HELICOIL® Plus thread inserts to process.

Tools for the installation of HELICOIL® Plus thread inserts with lengths > 2.5 d on request.

The installation tools are equipped with Bosch motors.

* Air consumption at 6.3 bar.

** The exchange units can be interchanged within the individual series.

Adapted tools for Inconel X 750, Nimonic 90 and aluminium inserts on request.

Pneumatic installation tool with leader cartridge type P-PSG for **HELICOIL® STRIPFEED®**



Exchange unit — nosepiece



Basic tool



Motor

Assemblies

Type**	Nominal thread Ø d	Exchange unit ≤ 1.25 d Order No	Exchange unit 1.5–2 d Order No	Basic tool Order No	Motor Order No
P-PSG 256 SF	M2.5	0160 272 5052	0160 272 5053	0160 370 0040	0160 370 0010
	M3	0160 270 3052	0160 270 3053		
	M4	0160 270 4052	0160 270 4053		
	M5	0160 270 5052	0160 270 5053		
	M6	0160 270 6052	0160 270 6053		
P-PSG 714 SF	M7	0160 280 7052	0160 280 7053	0160 180 0040	0160 180 0010
	M8	0160 280 8052	0160 280 8053		
	M10	0160 281 0052	0160 281 0053		



Leader cartridge



Installation mandrel



Coupling for installation mandrel



Range of compensation washers

Wear and spare parts — exchange unit

Type**	Nominal thread Ø d	Exchange unit ≤ 1.25 d Order No	Exchange unit 1.5–2 d Order No	Basic tool Order No	Motor Order No
P-PSG 256 SF	M2.5	0160 172 5035	0160 172 5033	0160 272 5020	0160 170 0006
	M3	0160 170 3035	0160 170 3034	0160 270 3020	
	M4	0160 170 4035	0160 170 4033	0160 270 4020	
	M5	0160 170 5035	0160 170 5033	0160 270 5020	
	M6	0160 170 6035	0160 170 6033	0160 270 6020	
P-PSG 714 SF	M7	0160 180 7035	0160 180 7033	0160 280 7020	0160 180 0006
	M8	0160 180 8035	0160 180 8033	0160 280 8020	
	M10	0160 181 0035	0160 181 0033	0160 281 0020	

Range of compensation washers ≤ M 6: Order No 0160 170 0060, ≥ M8: 0160 280 0060.



Parallel system type S for HELICOIL® Classic and HELICOIL® Plus installation tools

Type	Product characteristics		Order No
S 600	Work radius	130 mm – 450 mm	0182 080 0003 (see delivery scope)
	Work height	50 mm – 450 mm	
	Weight without tool	8 kg	
	Torque absorption	15 Nm max.	

Advantages

- Rationalisation
- Quick and safe positioning particularly for small sizes
- Easy handling, no operator fatigue
- No return rotation forces
- Absorption of screwdriver weight
- Can be used with electrical and pneumatic HELICOIL® installation tools
- Quick retooling
- 360° rotatable
- Smooth and precise roller guides
- Optimum workstation layout

Delivery scope

- 3-axis guiding system
- Tool holder
- 1 balancer 1–3 kg
- Base plate made of extruded aluminium profile with grooves, dimensions w x h x l: 240 x 40 x 500 mm

Accessories

Type	Size	Order No
Service unit	at 6 bar nominal flow G 01" = 700l/min	0182 080 1001
Stationary roller holder for HELICOIL® Plus STRIPFEED®		0182 080 0004
Hose	ID 6	0196 000 1130
Hose clip	8–12 mm	0196 000 1150
Hose tail	G 1/8"-6	0196 000 1151
Hose tail	G 1/4"-6	0196 000 1152
Exhaust air hose	Ø 15 mm	0196 000 1131

Drill chuck with external hexagon

DIN 3126 - E 6.3 for type B-S 206
Order No **4160 000 0100**



Manual installation tools for **HELICOIL®**

Manual installation tool for HELICOIL® Classic and HELICOIL® Plus

Only required for HELICOIL® Plus for fine screw threads and special applications.
For manual installation mandrels, see **page 50** (HELICOIL® Plus installation mandrels).



Type **H-PSG**:
Threaded mandrel, pitch-controlled,
with depth stop
Order No 0150 **01**. ...*



**Fly-over tool for
HELICOIL® Classic and HELICOIL® Plus**
Type **H-M**
with depth stop
Order No 0150 **07**. ...*



Type **H-PMG**:
Smooth mandrel, pitch-controlled,
with depth stop
on request



Type **H-PM**:
Smooth mandrel, without pitch control,
with depth stop
on request

Nominal thread Ø	Type	Installation tool with leader cartridge Order No	Fly-over tool Type H-M Order No
M2	H-PSG	0150 010 2000	–
M2.5	H-PSG	0150 012 5000	–
M3	H-PSG	0150 010 3000	–
M3.5	H-PSG	0150 013 5000	–
M4	H-PSG	0150 010 4000	–
M5	H-PSG	0150 010 5000	–
M6	H-PSG	0150 010 6000	–
M7	H-PSG	0150 010 7000	–
M8	H-PSG	0150 010 8000	–
M8 x 1	H-PSG	0150 010 8300	–
M9	H-PSG	0150 010 9000	–
M10	H-PSG	0150 011 0000	–
M10 x 1	H-PSG	0150 011 0300	–
M10 x 1.25	H-PSG	0150 011 0900	–
M11	H-PSG	0150 011 1000	–
M12	H-PSG	0150 011 2000	–
M12 x 1	H-PSG	0150 011 2300	–
M12 x 1.25	H-PSG	0150 011 2900	–
M12 x 1.5	H-PSG	0150 011 2400	–
M14	H-PSG	0150 011 4000	–
M14 x 1	H-PSG	0150 011 4300	–
M14 x 1.25	H-PSG	0150 011 4900	–
M14 x 1.5	H-PSG	0150 011 4400	–
M16	H-PSG	0150 011 6000	–
M16 x 1.5	H-PSG	0150 011 6400	–
M18	H-M	–	0150 071 8000
M18 x 1.5	H-PSG	0150 011 8400	–
M18 x 2	H-PSG	0150 011 8500	–
M20	H-M	–	0150 072 0000
M20 x 1.5	H-PSG	0150 012 0400	–
M20 x 2	H-PSG	0150 012 0500	–
M22	H-M	–	0150 072 2000
M22 x 1.5	H-PSG	0150 012 2400	–
M22 x 2	H-PSG	0150 012 2500	–
M24	H-M	–	0150 072 4000
M24 x 1.5	H-PSG	0150 012 4400	–
M24 x 2	H-PSG	0150 012 4500	–
M26 x 1.5	H-PSG	0150 012 6400	–
M27	H-M	–	0150 072 7000
M27 x 1.5	H-PSG	0150 012 7400	–
M27 x 2	H-PSG	0150 012 7500	–
M28 x 1.5	H-PSG	0150 012 8400	–
M30	H-M	–	0150 073 0000
M30 x 1.5	H-PSG	0150 013 0400	–
M30 x 2	H-PSG	0150 013 0500	–
M33	H-M	–	0150 073 3000
M33 x 2	H-PSG	0150 013 3500	–
M36	H-M	–	0150 073 6000
M36 x 1.5	H-PSG	0150 013 6400	–
M36 x 2	H-PSG	0150 013 6500	–
M36 x 3	H-PSG	0150 013 6600	–

* Adapted tools for Inconel X 750, Nimonic 90 and aluminium inserts on request.

Tang break-off tools and extraction tools for **HELICOIL®**



Tang break-off mandrel



Mechanical tang break-off tool with spring tension **type TB-M**



Pneumatic tang break-off tool with thrust trigger **type TB-P**

Tang break-off tools for HELICOIL® Plus

Nominal thread Ø	Tang break-off mandrel Order No	Type TB-M Order No	Type TB-P pneumatic system* Order No
M2	0158 040 0000	0158 602 0000	–
M2.5	0158 040 1000	0158 625 0000	–
M3	0158 040 1000	0158 603 0000	0168 040 3000
M3.5	0158 040 2000	0158 635 0000	–
M4	0158 040 2000	0158 604 0000	0168 040 4000
M5	0158 040 3000	0158 605 0000	0168 040 5000
M6	0158 040 3000	0158 606 0000	0168 040 6000
M7	0158 040 4000	0158 607 0000	0168 040 7000
M8	0158 040 4000	0158 608 0000	0168 040 8000
M9	0158 040 4000	0158 609 0000	–
M10	0158 040 5000	0158 610 0000	0168 041 0000
M11	0158 040 5000	0158 610 0000	–
M12	0158 040 6000	0158 612 0000	0168 041 2000

* Operating pressure 3–4 bar, connection G 1/4".

From M14, the tang must be removed with snipe nose pliers.



HELICOIL® extraction tool M3 to M5

HELICOIL® extraction tool

For the manual and machine extraction of HELICOIL® thread inserts M3 to M14 (larger sizes on request).

Delivery scope:

- Extraction tool
- Adapter for 1/4" hexagon
- Operating instructions
- Telescopic sleeve

Deep-installed HELICOIL® thread inserts can be extracted without damage to the holding thread:

	Steel	Aluminium R _m > 200 N/mm ² **	Aluminium R _m < 200 N/mm ² **
Flush-installed HELICOIL®	OK	OK	OK
Deep-installed HELICOIL®	OK	OK	conditional



HELICOIL® extraction tool M6 to M56

Nominal thread Ø	Order No
M3	0180 603 0000
M4	0180 604 0000
M5	0180 605 0000
M6	0180 606 0000
M8	0180 608 0000
M10	0180 610 0000
M12	0180 612 0000
M14	0180 614 0000

From M16 on request.

The tool can be mounted using a tap wrench, ratchet or cordless screwdriver. The delivery scope includes an adapter for a cordless screwdriver.

** 1 N/mm² equals 1 MPa.



For thread repair, HELICOIL® thread inserts are internationally approved for the economical and permanent repair of damaged or worn out threads.

Damaged nut threads must be repaired on spark plugs, studs, oil drain plugs or exhaust fixtures, for example. Such thread damage occurs rather frequently and often requires time-consuming and complicated repair.

We also offer solutions for those applications — our HELICOIL® repair kits.

They are used to quickly and easily form threads in the previous nominal diameter — even at points which are difficult to access. Besides the repair of valuable individual components, parts used in large-scale production which have been rejected due to faults during thread production can be reintegrated into the production process.

Perfect handling, reliable and sustainable result — circular economy.*



Example: standard solution**

HELICOIL® Kit — metric

M2 – M16 x 1.5

Metric ISO thread, stainless steel A2

Items:

- HELICOIL® Plus thread inserts in 3 lengths
- Twist drills (up to M12)
- HELICOIL® HSS manual tap
- HELICOIL® Plus installation mandrel
- Tang break-off tool (up to M12)

*"The circular economy is a model of production and consumption, which involves sharing, leasing, reusing, repairing, refurbishing and recycling existing materials and products for as long as possible. This way, the life cycle of products is extended."

Source: www.europarl.europa.eu/ (...) 07/10/2019

** Further HELICOIL® kits, ranges and refill packs in metric (M2 to M36) and imperial sizes (UNC, UNF, BSW, BSF, G) on request.

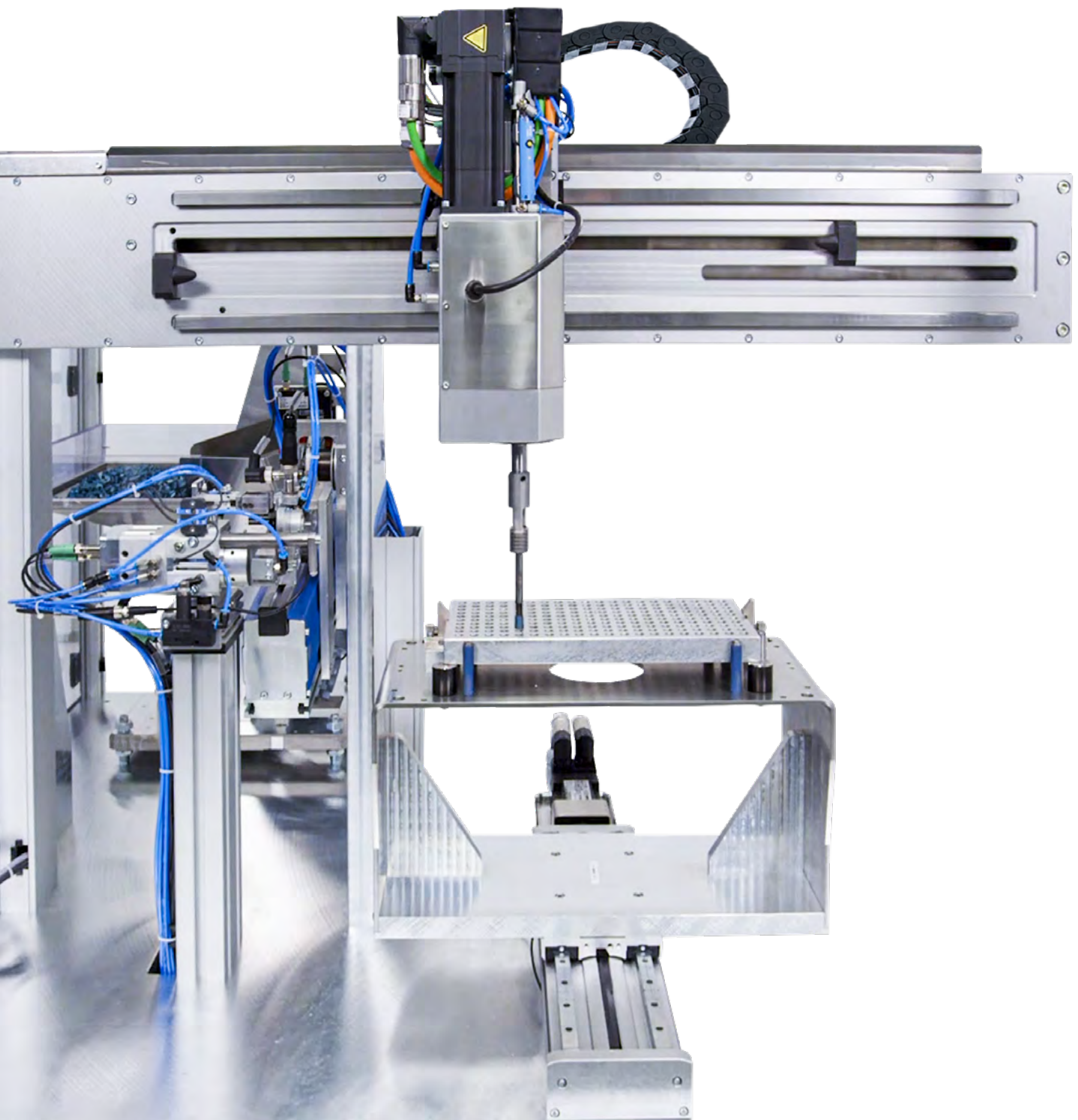

HELICOIL® system modules — automated processing	70
Stationary screwdriver system	70
Automatic 3-axis system	71
Screwdriver module for robot connection	72
Feeders and pre-separation through blow feed or anyfeed	73
Robot-coupled hand tools	74

HELICOIL® system modules — automated processing



Automated screw joints with high process reliability that make maximum use of the potentials of lightweight construction. As your partner for the 360° Joining Technology, we strive to improve your competitiveness, optimise processes and allow for sustainable savings. By intertwining fastener know-how and our competence in automation, efficient solutions are created. Processing systems for the integration into automation systems as well as complete systems are available. We have the focus on your requirements. All HELICOIL® automations — components as well as complete systems — feature a built-in control, drive and operating system with high flexibility and connectivity for linked system concepts.

Please find examples of processing systems below.

Stationary screwdriver system

**Do you employ robot handling with a robot holding the component?
Do you use a rotary indexing table or a transfer system?**

The solution is the stationary screwdriver system with an automatic feed of HELICOIL® thread inserts through pick-and-place or blow feed.

The standard configurations of all systems are as follows:

- Feeder
- Screwdriver system
- Tang break-off tool
- Operating panel

Your advantages — an overview:

- 100-% process monitoring (see ¹⁾ on **page 71**)
- Suited for large-scale production
- Integration into automatic production processes

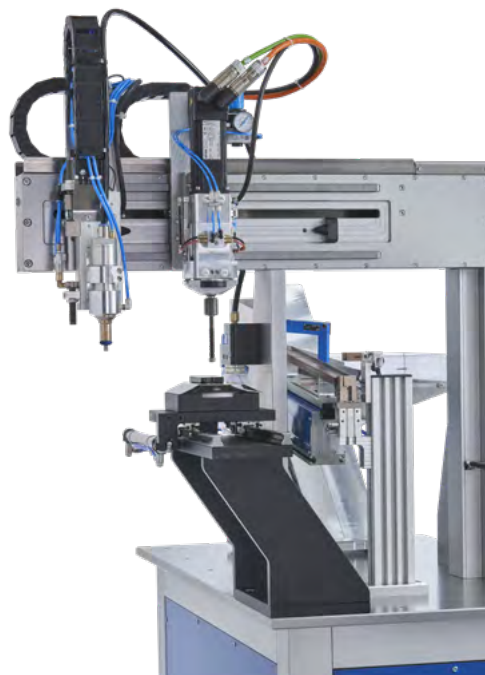

Automatic 3-axis system

You require complete process monitoring of the HELICOIL® installation and do not want to use a fully automatic system for economical reasons?

The automatic 3-axis system can be easily integrated into a manual workstation. The component to be installed is manually fixed on a holding fixture. Then, the fully automatic HELICOIL® installation is started.

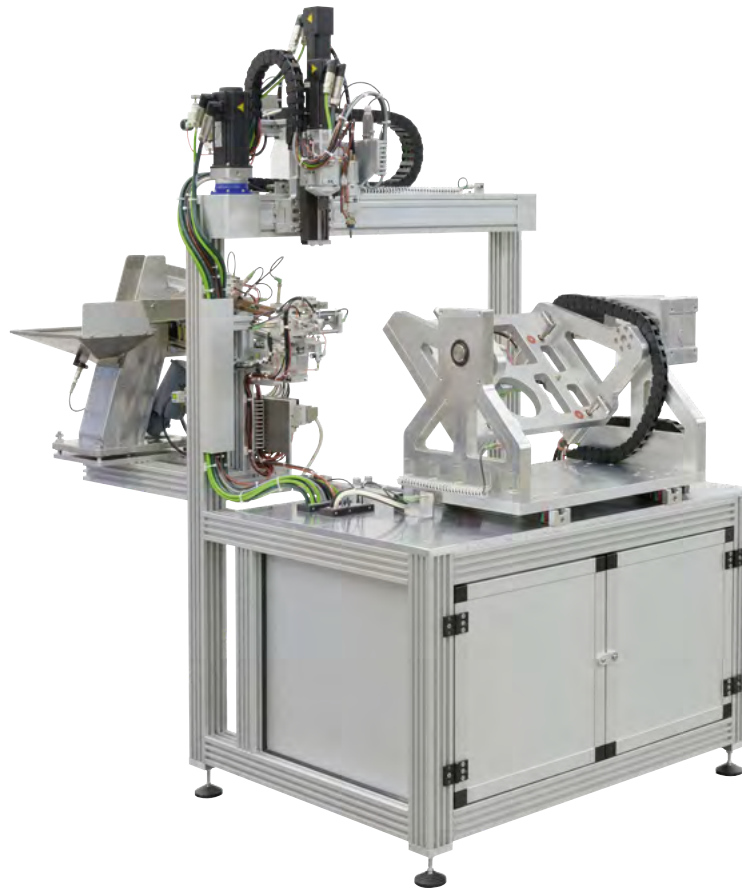

Your advantages — an overview:

- 100-% process monitoring¹⁾
- Economical, automated production, also for a smaller number of pieces
- Low personnel occupation
- Saving potential through parallel processing of upstream and downstream installation steps
- Suited for large-scale production
- Integration into manual workstations or robot cells with a handling robot

¹⁾ Parameter monitoring:

- Controlled number of rotations of the installation mandrel required for screwing-in
- Check of the HELICOIL® Plus installation depth (final tang position) by means of a linear measuring system
- Power consumption of the servo motor to detect too tight holding threads not true to gauge
- For blind holes, tang break is directly queried.
For through holes, the customer issues the query indirectly.
- Time window for the HELICOIL® Plus installation

Screwdriver module for robot connection

Your production is robot-aided? You need a flexible production process?

The HELICOIL® screwdriver module with a standard adapter plate to connect a robot is perfect for applications in large-scale production if you need maximum flexibility.

The component is fixed in a holding fixture.

The thread inserts are continuously fed by means of a pick-and-place system.

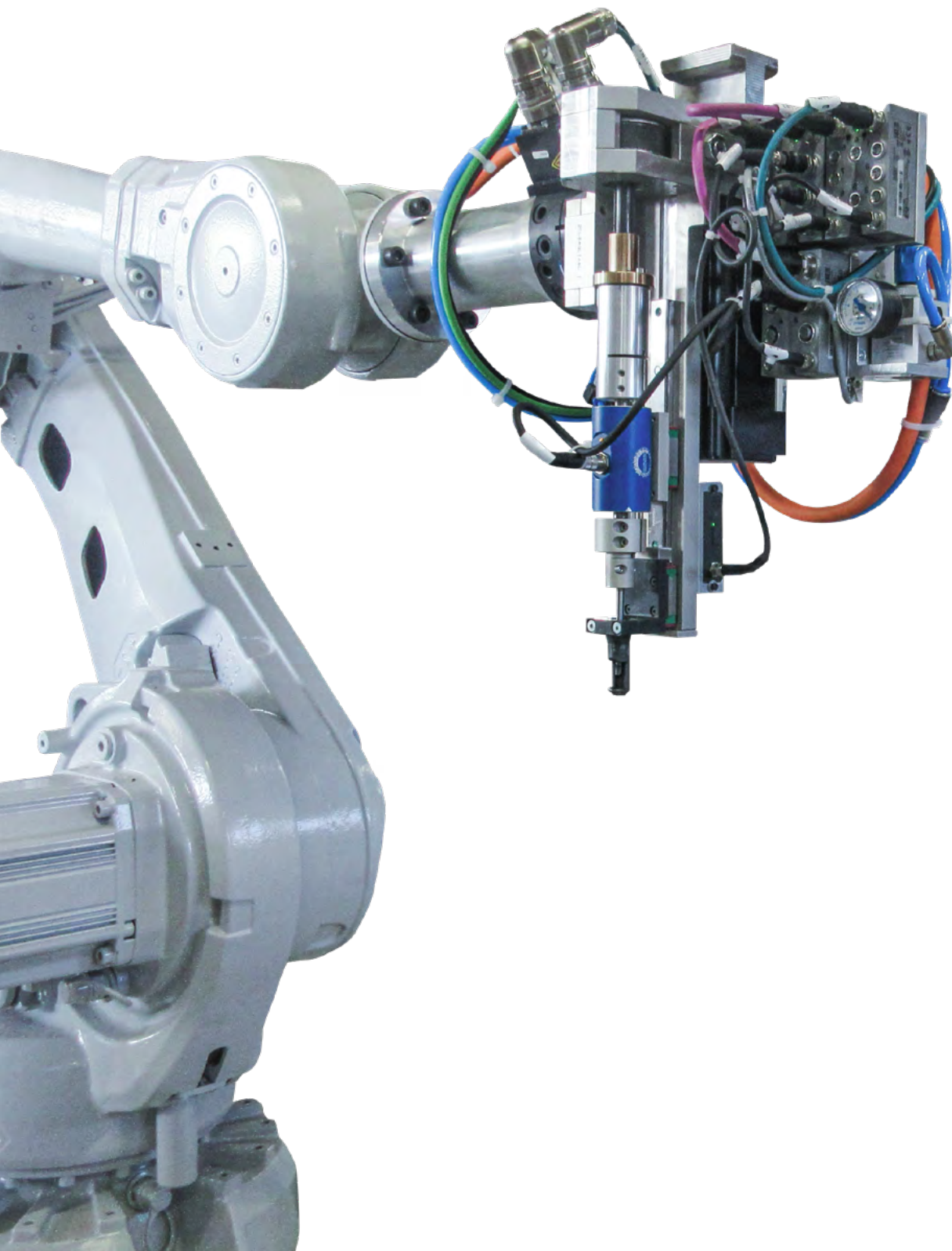

Blow feed

According to the customer requirements, pick-and-place or blow feed systems are used for the automatic feed of HELICOIL® thread inserts. Since it is a system of high economic efficiency, the fast-working blow feed system is particularly suited for large-scale productions.

Depending on the type of system, several screwdriver systems can be supplied by one separation unit through the respective switches. The screwdriver systems and the parts separation (incl. hopper system) can also be placed separately at some distance toward each other so that the system layout is very flexible.



Anyfeeder



Robot-coupled hand tools



Closing the gap between power tools and full automation

Efficient combination: a robot handling system combined with our power tools to form a flexible automation system which ensures an installation process in all space and angular positions with high process reliability. The robot allows to adjust the joining positions fast and easily.

Your advantages — an overview:

Efficiency

- Smaller work load on employees
- Performance of non-ergonomic tasks
- More productive time

Flexibility

- Fast and easy adaptation to new joining scenarios and components
- Installation in any angular position

Reliability

- Enhanced process monitoring by the robot
- Position detection, force-torque sensor
- Reproducible quality

Simplification

Full package from a single source:

- Robot with built-in safety technology
- Installation tool
- Control system
- Installation table and installation bracket

Passion for successful joining.



So what does this mean for you?

Our passion to provide you with the perfect solution when it comes to joining technology – standardised as well as customer-specific. Worldwide.

For that, we rely on our enthusiastic team, our innovation capacity as well as our 360° Joining Technology which stands for a wide portfolio of joining solutions, processing systems and services.

Innovation and development partner

- Modern methods, organisational forms and processes
- Trend analyses
- Research cooperations
- Open innovation
- In-house research and development
- Application engineering and consulting
- Customer-specific development parts
- Manufacture of samples and prototypes
- Value analyses

Procurement and assembly partner

- Engineering competence thanks to in-house production
- Fourteen modern production facilities worldwide
- Production methods
 - Injection moulding
 - Turning
 - Cold working
 - Wire winding
 - Mechanical and plant engineering
- Acceleration of your assembly processes
- Wide range of manual and automated assembly solutions

Logistics and quality partner

- Supply chain solutions
- Quality management according to IATF 16949
- Quality management according to EN 9100
- Distinctive quality and environmental awareness
 - Accreditation of the in-house laboratory according to DIN EN ISO/IEC 17025
 - Certification according to DIN EN ISO 14001
 - Certification according to DIN EN ISO 19443
- Regular audits through customers

Distributor and service partner

- Efficient consulting, assistance and service
- Local expert specialists
- Proximity to customers thanks to global presence
- After-sales service
- Expert seminars, training and workshops
- Online seminars
- Customer in-house fairs

Please do not hesitate to contact us.

We are looking forward to our next joint success story.



Innovative thread technology meets die-cast aluminium — **HELICOIL® Cast**



The new HELICOIL® Cast allows to form metallic threads in light-metal components (die-cast aluminium) through in-moulding.

The thread insert consists of an asymmetric rolled A2 stainless steel wire (A4 option) which is wound to form a fixed bushing with at least one flange-like expansion. With the successful use of the IMTEC® CO — its counterpart for plastic injection moulding — and the intelligent interplay of idea and innovation management, Böllhoff discovered the demand to explore the amplification of the field of use to die-cast aluminium.

The focus was on two manufacturing processes during which liquid or pasty aluminium is cast or forced into pre-heated steel moulds (tools or dies) under pressure (in one case) or high pressure (in the other case).

Special challenges resulted from a mass melting temperature ≥ 660 °C, thermal damage to surfaces and thread inserts (effects of corrosion), an extremely low viscosity and different casting methods such as low-pressure casting (gravity casting, permanent mould casting ...) and die casting (10–200 MPa; 12 m/s).

Product news

Low-pressure casting



Permanent metal mould

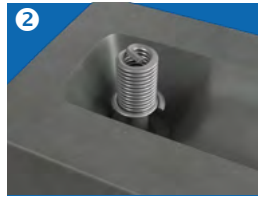

Plugging the HELICOIL® Cast on a smooth core pin



Casting the liquid melted aluminium into the transfer chamber without pressure using dosing machines or manually from a ladle

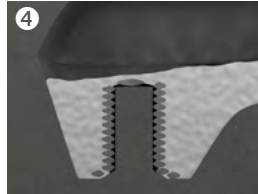

The liquid melted aluminium fills the mould and encloses the HELICOIL® Cast without flowing into the internal thread.

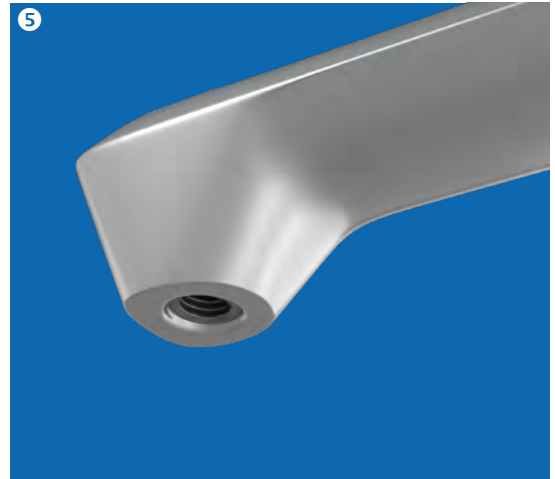

After the solidifying melt has cooled, a wear-free, high-strength thread has been formed in your high-quality light-metal components.

Die casting



Steel mould, HELICOIL® Cast and automatic spindle device



Spun on HELICOIL® Cast



The liquid melted aluminium forced in under high pressure fills the mould and encloses the HELICOIL® Cast on the spindle core without flowing into the internal thread.

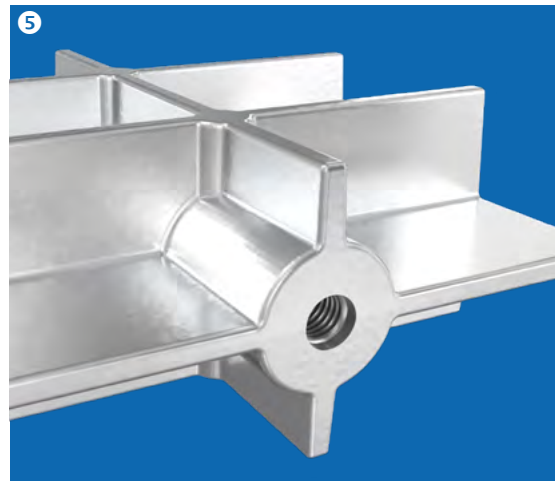
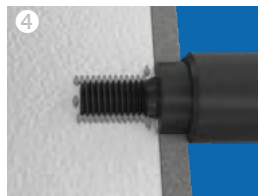

After the solidifying melt has cooled, a wear-free, high-strength thread has also in this case been formed in your high-quality light-metal components.

The performed tests showed that smooth core pins are sufficient for the use of the HELICOIL® Cast for the low-pressure method and that spindle cores (= threads) are required for methods involving higher compressive forces in order to prevent the liquid aluminium from flowing into the internal thread. The validation tests with automatic spindle devices as well as the corrosion tests were passed on the OEM level.

The user benefits from this intelligent combination among other things because of the possibility to mould functional elements directly to the component with high process reliability — functional integration.

Whichever method you choose, in any case a wear-free and stable thread will be formed in high-quality lightweight components.

Do you have any questions?
Please do not hesitate to contact us.

Catalogues – fasteners and processing systems



HELICOIL® Smart

The new generation of thread technology for high-strength joints
Catalogue No 0155

<https://www.boellhoff.com/en/pdf/helicoil-smart>



**HELICOIL® Plus
thread technology**

Intelligent system solution comprising a fastener and efficient processing for high-strength screw joints
Catalogue No 0100

<https://www.boellhoff.com/en/helicoil-plus>



HELICOIL® Plus

Thread technology for high-strength joints – imperial threads UNC, UNF, BSW, BSF, BSP/G, BA
Catalogue No 0101

<https://www.boellhoff.com/en/pdf/helicoil-plus-imperial>



HELICOIL® Tangfree

The tangfree coil thread insert for high-strength threads – metric threads – imperial threads: UNC and UNF
Catalogue No 0150

<https://www.boellhoff.com/en/helicoil-tangfree>



**HELICOIL® E-PSG
Process-Controlled**

Fast installation of HELICOIL® thread inserts with high process reliability
Catalogue No 0157

<https://www.boellhoff.com/en/pdf/helicoil-epsq-process-controlled>

Product overview



360° Joining Technology

Catalogue No 1190

<https://www.boellhoff.com/en/pdf/product-guide>

Industry-specific catalogues – automotive industry/aerospace industry



**Automotive engineering meets
360° Joining Technology**

Exterior – headlights and rear lights
Catalogue No 0943

<https://www.boellhoff.com/en/pdf/lighting-solutions>



**360° Joining Technology
Car repair solutions**

Catalogue No 0195

<https://www.boellhoff.com/en/pdf/car-repair-solutions>



**E-mobility meets
360° Joining Technology**

Catalogue No 8024

<https://www.boellhoff.com/en/pdf/e-mobility>



**Aerospace industry meets
360° Joining Technology**

Catalogue No 0951

<https://www.boellhoff.com/en/pdf/aerospace>

Fastener videos



HELICOIL® Plus Free Running

Thread inserts for high-strength joints — free running

<https://www.boellhoff.com/video/helicoil-plus>



HELICOIL® Plus Screwlock

Thread inserts for high-strength joints — with screw loss protection

<https://www.boellhoff.com/video/helicoil-plus-screwlock>



HELICOIL® Smart

The new generation of thread technology for high-strength joints

<https://www.boellhoff.com/video/helicoil-smart>



HELICOIL® Tangfree Free Running

Tangfree thread inserts for high-strength joints — free running

<https://www.boellhoff.com/video/helicoil-tangfree>



HELICOIL® Tangfree Screwlock

Tangfree thread insert for high-strength joints — with screw loss protection

<https://www.boellhoff.com/video/helicoil-tangfree-screwlock>



HELICOIL® Cast

High-strength thread inserts for in-moulding processes — die-cast aluminium

<https://www.boellhoff.com/video/helicoil-cast-for-cast-aluminium>

Installation videos



HELICOIL® Smart

P-S 408S pneumatic installation tool

<https://www.boellhoff.com/video/helicoil-smart-installation-with-p-s-408>



HELICOIL® E-PSG 256 Quick Exchange

Electrical HELICOIL® installation tool for the quick change of different sizes

<https://www.boellhoff.com/video/helicoil-installation-with-e-psg-256>



HELICOIL® Smart

Thread technology for high-strength joints in automation

<https://www.boellhoff.com/video/helicoil-smart-automation>



HELICOIL® depth gauge

Easy measuring and documentation of the installation depth for installed HELICOIL® thread inserts

<https://www.boellhoff.com/video/en/good2know/helicoil-depth-gauge>

You have any questions or a running project?
Feel free to contact us.

BÖLLHOFF

Passion for successful joining.

Böllhoff Group

Innovative partner in the field of joining technology offering assembly and logistics solutions.

Please go to www.boellhoff.com to find the contact details of our locations worldwide.

Archimedesstraße 1–4 | 33649 Bielefeld | Germany
Phone +49 521 4482-515 | fat@boellhoff.com | www.boellhoff.com

Technical changes reserved.
Reprint, in extracts or in whole, only with explicit authorisation.
Observe protection notice according to ISO 16016.