

# OPERATION MANUAL

Cross Section Monitor

# CS07

Version 4.0  
Jan 18, 2024





# TABLE OF CONTENTS

<b>1</b>	<b>CS07 MAIN UNIT &amp; ACCESSORIES</b> .....	<b>6</b>
<b>2</b>	<b>PRODUCT DESCRIPTION</b> .....	<b>7</b>
2.1	FRONT.....	7
2.2	REAR.....	8
<b>3</b>	<b>OPERATION OF LCD PANEL</b> .....	<b>9</b>
3.1	HOME SCREEN.....	9
3.2	ADVANCED SETTINGS.....	9
<b>4</b>	<b>STANDARD WIRE CROSS SECTION</b> .....	<b>10</b>
4.1	SETTING THE TERMINALS .....	10
4.2	ADJUSTING THE CUTTING POSITION .....	15
4.3	CUTTING THE TERMINALS.....	17
4.4	GRINDING THE TERMINALS.....	18
4.5	TAKING CROSS SECTION PHOTOS.....	19
<b>5</b>	<b>REPLACING &amp; CLEANING CONSUMABLES</b> .....	<b>20</b>
5.1	REPLACING THE CUTTING WHEEL.....	20
5.2	REPLACING THE SANDPAPER.....	21
5.3	CLEANING THE INTERNAL CUTTING AREA .....	23
5.4	DISPOSING THE CUTTING DEBRIS.....	24
<b>6</b>	<b>TROUBLE SHOOTING</b> .....	<b>26</b>
<b>7</b>	<b>BIG WIRE CROSS SECTION</b> .....	<b>28</b>
7.1	BIG WIRE CUTTING OPTIONAL COMPONENTS .....	28
7.2	INSTALLING THE VACUUM DEVICE.....	29
7.3	INSTALLING THE AUXILIARY LENS .....	31
7.4	SETTING THE TERMINALS .....	32
7.5	CUTTING THE BIG WIRES.....	35
7.6	TAKING CROSS SECTION PHOTOS.....	36
7.7	CLEANING THE VACUUM UNIT .....	37
<b>8</b>	<b>LONGITUDINAL CROSS SECTION</b> .....	<b>38</b>
8.1	LONGITUDINAL CROSS SECTION OPTIONAL COMPONENTS .....	38
8.2	ASSEMBLING THE GRINDING WHEEL.....	39
8.3	SETTING THE TERMINALS .....	41
8.4	GRINDING THE TERMINALS.....	43
8.5	TAKING CROSS SECTION PHOTOS.....	45
<b>9</b>	<b>SPECIFICATIONS</b> .....	<b>46</b>
9.1	CS07 SPECIFICATIONS .....	46
9.2	STANDARD LENS SPECIFICATIONS .....	46
9.3	CAMERA SPECIFICATIONS.....	46
9.4	CS07 DIMENSIONS .....	47
<b>10</b>	<b>WARRANTY</b> .....	<b>48</b>

## BEFORE USE



Please read this instruction manual carefully before handling this device. These instructions contain important information which helps you prevent harm to human life and property, while getting the best out of the appliance and ensure safe and proper installation, use and maintenance.

In case of connecting CS07 to other measuring devices, please also refer to “Precautions” of those devices.

Please keep the instruction manual in convenient places so that you can always refer to it for the safe and proper use of the device.

**WARNING DEFINITIONS** (Be sure to read these guidelines and precautions before handling the equipment)

The safety precautions are classified into 2 categories: “Warning” and “Caution”. Depending on circumstances, procedures indicated by  may result in serious consequences, so be sure to follow the directions for usage.

 <b>WARNING</b>	Procedures which may lead to dangerous conditions and cause death or serious injury, if not carried out properly.
 <b>CAUTION</b>	Procedures which may lead to dangerous conditions and cause superficial to medium injury or physical damage, property damage, or may degrade or damage the product, if not carried out properly.



When using this machine, these safety precautions should always be followed to reduce the risk of fire, electric shock, damage to property, or injury to people:

(1)	Only use the adapter provided with your device. Otherwise, make sure the power supply is within the range of this device before supplying power.
(2)	Unplug the device from the AC socket immediately when there is unusual smell, heating or smoke. Please contact your local dealership or contact us for inspection.
(3)	Do not use CS07 in case there was a strong impact on it or it was dropped. Please contact your local dealership or contact us for inspection.
(4)	Do not attempt to repair, modify or disassemble the equipment. These procedures should only be undertaken by True Soltec or other qualified service personnel.
(5)	Unplug the machine and other surrounding devices from AC outlet, before installing or connecting CS07 to other devices.
(6)	Do not let liquids or foreign objects (such as staple or clip) enter CS07, as it could result in short circuit. Should any liquids or foreign objects enter the device, switch the power off immediately and contact your dealership or contact us for inspection.
(7)	Avoid places where high moisture or humidity (such as bathroom) are present. Do not touch or use the device with wet or damp hands when the power is on.
(8)	Wear rubber gloves and insulated boots in order to avoid electric shock that might happen if accidentally touch the conductor.
(9)	Wear safety goggles to avoid the risk of etching solution flying into your eyes when handling this equipment.
(10)	Do not touch the terminal surface within the first few minutes after etching. It might cause a burn.



	<p><b>USAGE AND STORAGE</b></p> <p>CS07 is intended to be used under the following environmental conditions to avoid damage to the product, and prevent it from malfunctions or deformation:</p> <ul style="list-style-type: none"><li>● No exposure to direct sunlight. Operation temperature range: 10~40°C, Humidity range: 20~85%</li><li>● Do not place it near sources of heat or fire.</li></ul> <p>(1)</p> <ul style="list-style-type: none"><li>● Do not place it near salt, oil, or corrosive gas.</li><li>● Avoid places where power leakage, vibration, and static electricity are present.</li><li>● Do not place it inside a car, trunk, or magnetic fields.</li><li>● Do not place it on unstable or rough surfaces.</li></ul>
<p>(2)</p>	<p><b>POWER SUPPLY</b></p> <ul style="list-style-type: none"><li>● The interval between power ON &amp; OFF should be at least 10 seconds.</li><li>● Do not use the power supply that exceeds the rating. It may cause damage to the device.</li></ul>

# 1 CS07 MAIN UNIT & ACCESSORIES

## CS07 COMPONENTS:

CS07 Main Unit



USB Camera



USB cable



Microscope lens



Ring LED



Calibration Stand



Micro Gauge

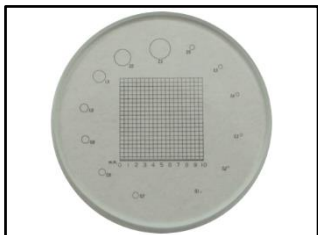

Power cord



Male to male USB cord



Standard Clamp



Sandpaper (#1200) 25pcs

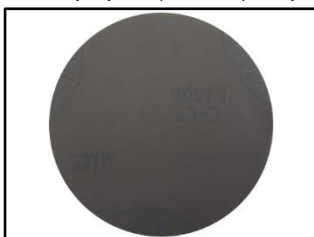

Cutting wheel 10pcs



Wheel Bearing (Standard)



Cross Section Analysis Software (CS07HI or X-SCAN) and dongle key



## 2 PRODUCT DESCRIPTION

### 2.1 FRONT

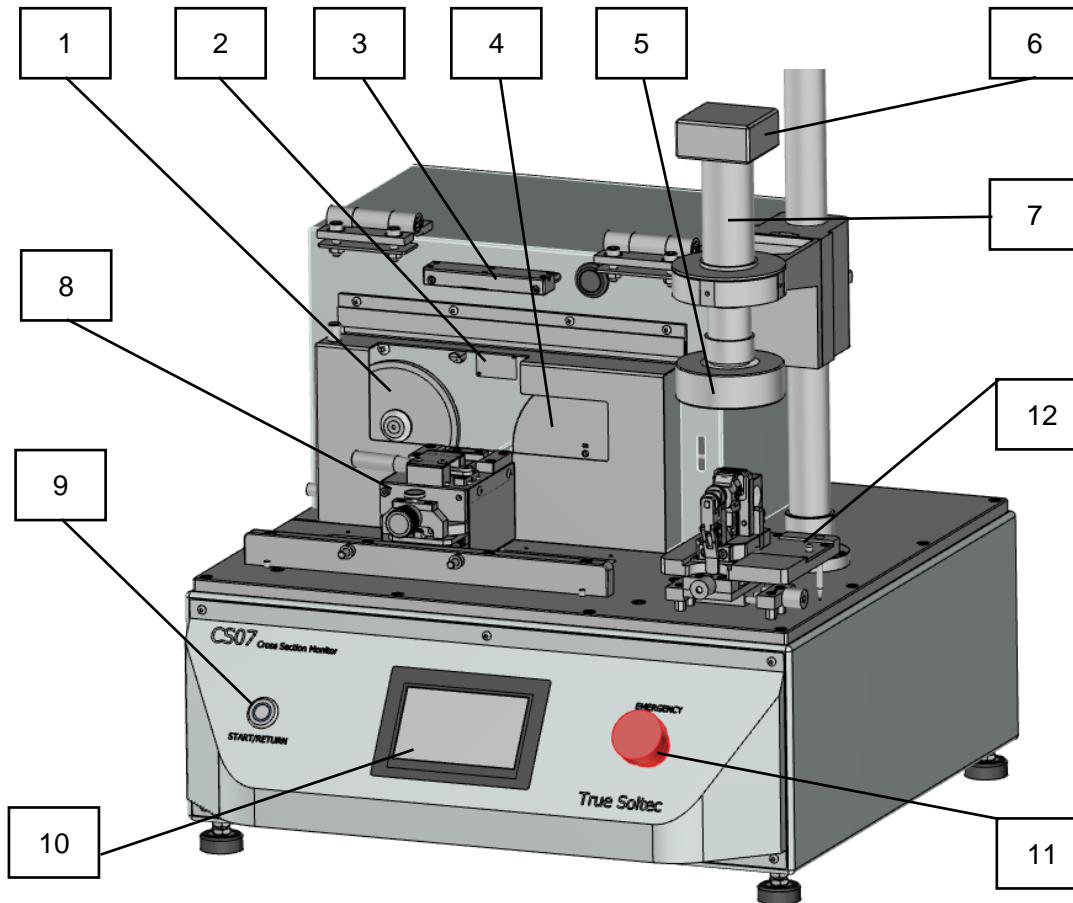

1	Cutting wheel	Cut terminals Press <b>START</b> button → The cutting disc rotates and cuts the terminal.
2	Box LED	Provide light for the position checking camera. Adjust the LED brightness via the LCD screen.
3	Position checking camera	Check a cutting position. Only valid when using with CS07HI software. Refer to <b>CS07HI Instruction Manual</b> for details on usage.
4	Grinding disc	Grind the terminal surface. Only activate in standard cutting mode. CS07 automatically grinds the surface after cutting it, or when pressing <b>START</b> button at grinding mode.
5	Ring LED	Provide light for USB camera. Adjust the Led brightness via the LCD screen.
6	USB Camera	Connect with your computer to take cross-section photos
7	Microscope lens	Connect with USB camera and ring LED
8	Clamp Transfer Unit	Set the clamp onto this unit. It is a moving part that moves the clamp to cutting disc and grinding wheel during operation.
9	<b>START / RETURN</b> button	Press <b>START</b> button → CS07 automatically cut and/or grind the terminals
10	LCD Operation Panel	Control the operation (cutting, grinding, changing LED brightness....)
11	<b>EMERGENCY</b> button	Immediately stop the machine if there are abnormalities.
12	Clamp Holding Stand	Set the clamp onto this stand → Take cross-section photos



## 2.2 REAR

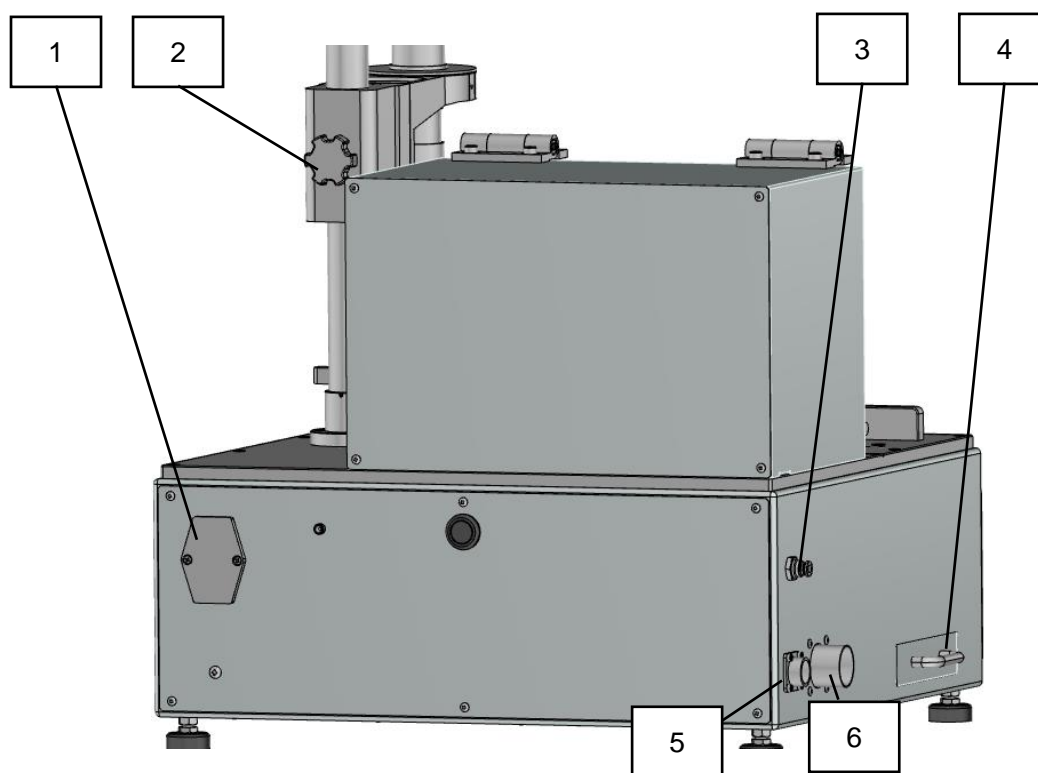

1	Power switch	Plug the power cable in → Turn on the power
2	Lens lock screw	Loosen this lock screw to move the camera & lens up and down. ※Hold the camera while loosening this screw
3	Air flow	Connect with an air tube to let the air into the main unit.
4	Metal debris tray	Hold terminal dust/ debris after being cut. Periodically clean this tray
5	Power supply for vacuum unit	Provide power for the vacuum unit.
6	Metal dust	Hold the metal dust discharged by the vacuum unit



## 4 STANDARD WIRE CROSS SECTION

### 4.1 HOW TO INSTALL THE CAMERA UNIT

1. Attach the column to the camera unit base and tighten the set screws to secure it.

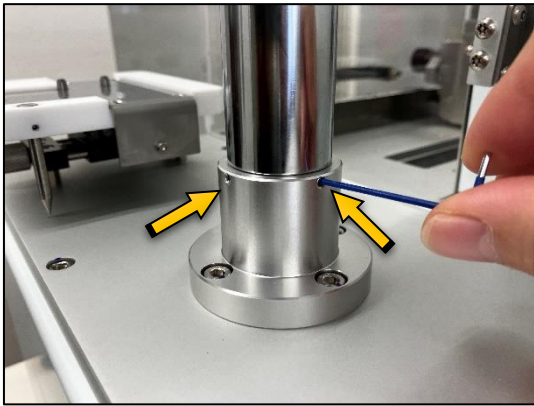

2. Attach the lens lifting unit to the column and tighten the fixing knob.

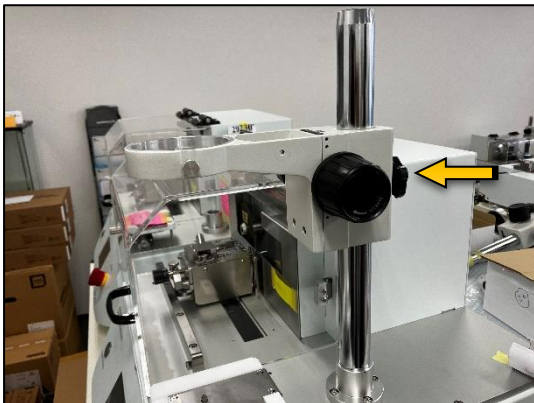

3. Remove the cap at the bottom of the lens.



4. Attach the lens to the lens lifting unit.

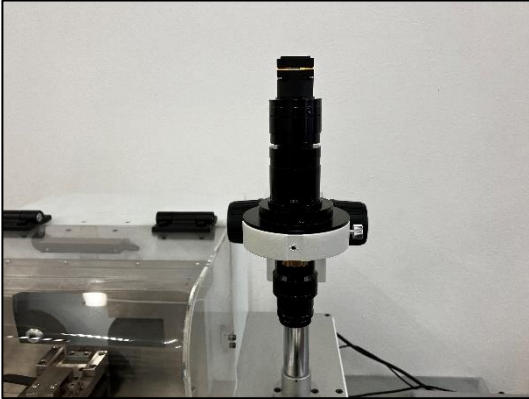

5. Turn the magnification display and white vertical line of the lens toward the front.



6. Tighten the lens fixing knob to fix the lens.

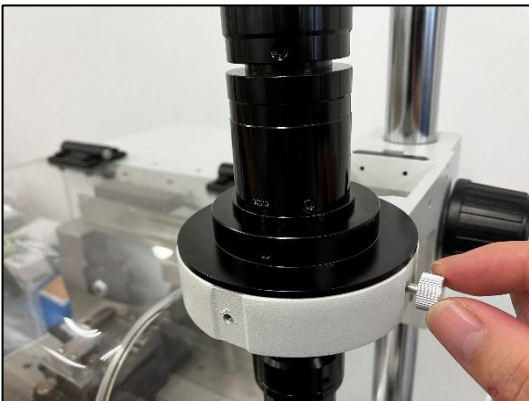

7. Attach the ring light to the lens while rotating it.

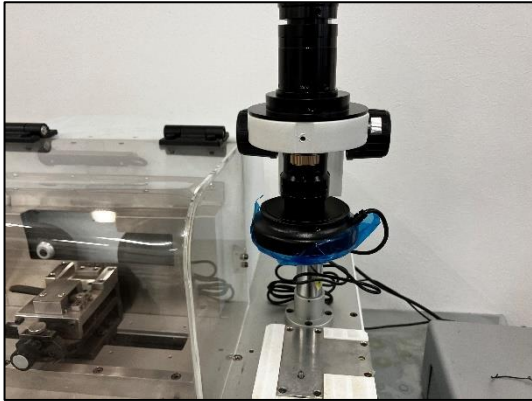

8. Plug the cable into the ring lighting power jack on the back of the main unit.



## 4.2 SETTING THE TERMINALS

1. Loosen the clamp screw by rotating it counterclockwise (red circle).
2. Place the wire into the V groove vertically (below photo).  
The sample should be straight up, not bending to the left/ right or up/ down
3. Rotate the screw clockwise to tighten the terminal firmly.

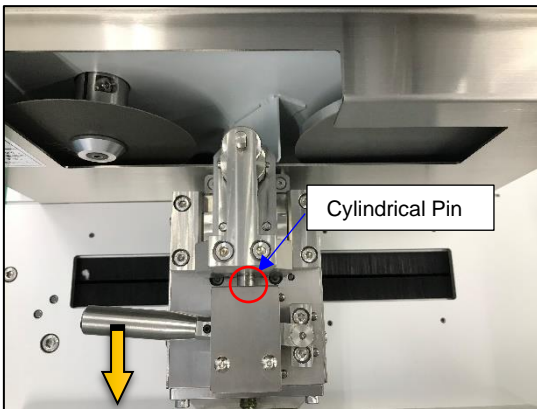
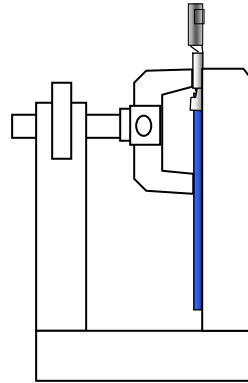
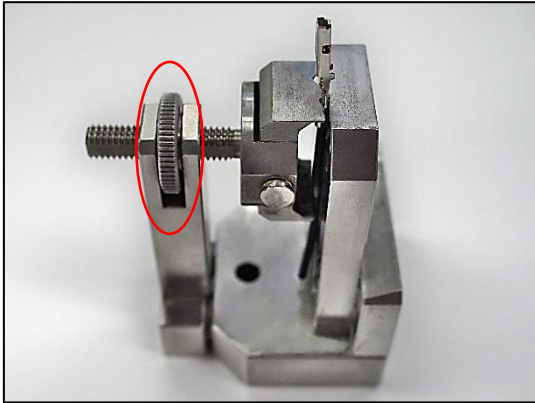

### At Clamp Transfer Unit:

4. Pull the lever down
5. Place the clamp on the transfer unit.  
Align the clamp fixing hole with the cylindrical pin.
6. Release the lever.

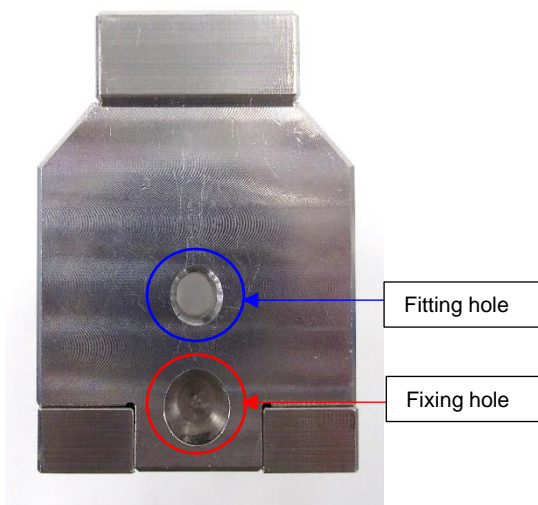

※Each type of clamp is designed to have 2 holes on its body:

- **Fixing hole:** Used when placing the clamp on the transfer unit.
- **Fitting hole:** Used when placing the clamp on the clamp holding stand.

※Choose a proper V groove depending on the terminal size.

Applicable wire size (for reference):

- **Small V groove (Width 1.3mm, Height 0.4mm)**

AWG24 ~ AWG32

- **Medium V groove (W 2.7mm, H 0.8mm)**

AWG14 ~ AWG28

- **Large V groove (W 5.6mm, H 1.6mm)**

AWG10 ~ AWG16 (Big-wire clamp)

The protrusion length of wires after fixing into the clamp should be 30mm or less.

If the wire protrudes more than 30mm, cut off the wire tip to make it shorter.



Large V groove

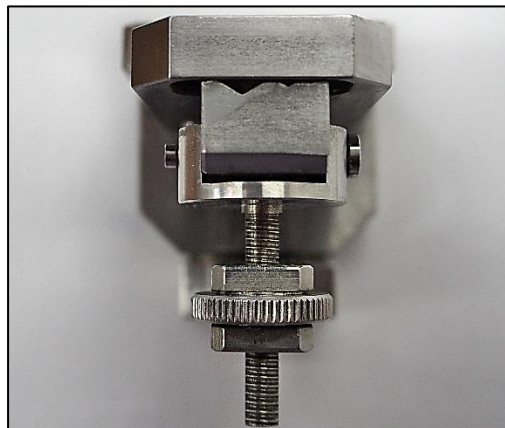

Small and Medium V groove

 **CAUTION**

- The samples should be placed firmly into the clamp. The clamp should be placed correctly on the transfer unit. Improper placements may cause damage to the cutting and grinding wheel.
- The clamp tightening bracket should not be pushed forward. Improper placements may cause damage to the cutting and grinding wheel.

### 4.3 ADJUSTING THE CUTTING POSITION

This function is only valid if using with CS07HI software. It helps locate a proper cutting position (measurement position).

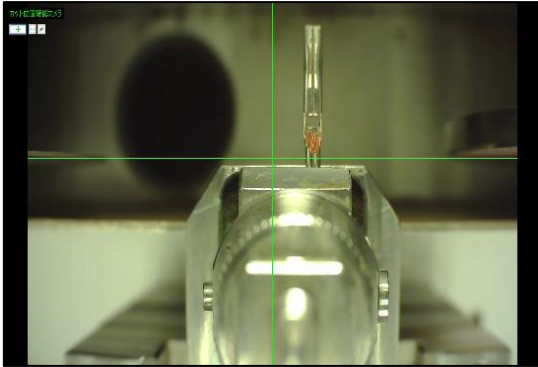

#### **Usage:**

1. Open CS07 software.
2. Activate the position checking camera.  
→ 2 green lines appear.  
→ Check if the terminal is set up straight vertically, and if it is perpendicular to the horizontal line or not, based on these lines.

(Refer to **CS07HI operation manual** for details)

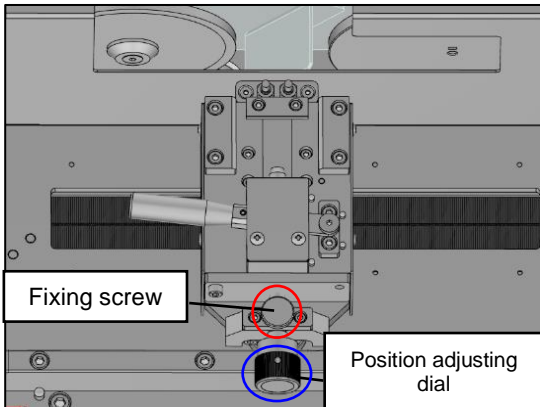

3. Loosen the fixing screw by rotating it counterclockwise.  
This screw prevents the position adjusting dial from moving.

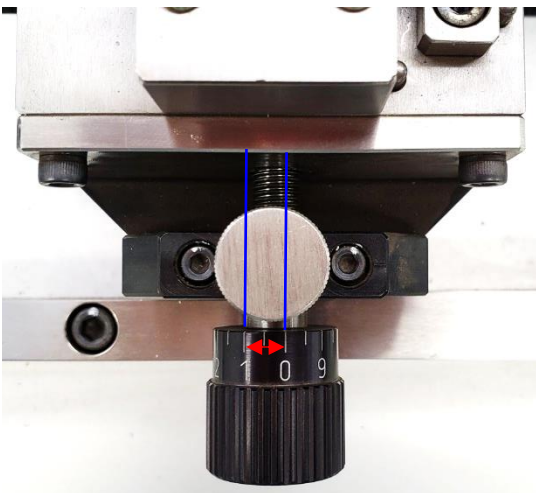

4. Rotate the position adjusting dial clockwise to change the cutting position.

The position, where the horizontal green line goes across, is the cutting position.

Each step = 0.1mm  
e.g: 0~1 = + 0.1mm  
0~2 = + 0.2mm  
0~3 = + 0.3mm

5. After changing the position, tighten the fixing screw again.  
Close the safety cover.



**NOTE:**

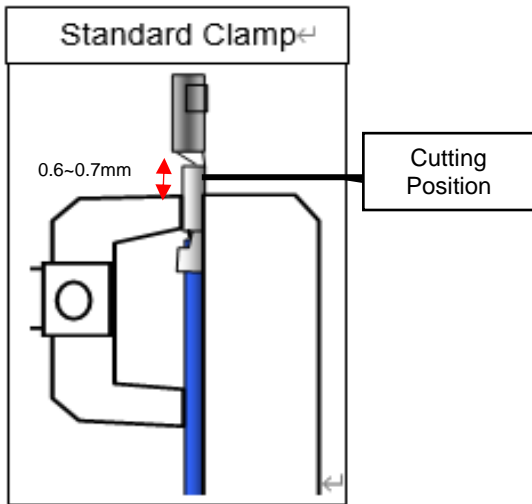

※Moving range of the transfer unit: **5mm**

When the transfer unit is at its innermost position (nearest position from the cutting wheel), after cutting, the distance from the cutting position to the clamp surface is approx. **0.6 ~ 0.7mm**.

After grinding, this distance is approx. **0.5mm**

 **CAUTION**

- The fixing screw must be tightened firmly before operation. Otherwise, it may cause damage to the device.
- When grinding the surface again, only move the clamp to the front **0.2mm or less each time**. Otherwise, it may cause damage to the device.

## 4.4 CUTTING THE TERMINALS

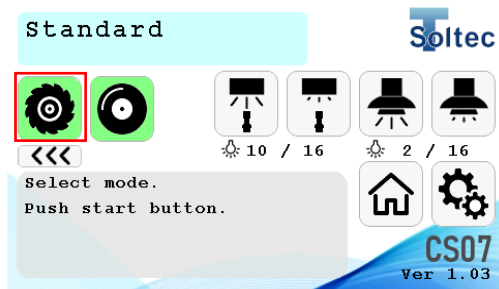

On LCD operation screen, check if both cutting mode and grinding mode are activated.

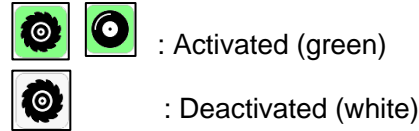

Touch the buttons to activate/ deactivate them.

⏪⏪⏪ Touch this button to select a proper cutting speed – 3 modes

Standard ⏪⏪⏪ 1mm/sec

Medium ⏪ 0.5mm/sec

Slow 0.15mm/sec

※This function is only valid when the standard clamp is used.



- Press **START** button.  
→ CS07 automatically cuts the terminal.  
When the transfer unit reaches its leftmost limit, it will return to its home position.

Then, it will keep moving to the right to have the terminal ground.  
Finally, it returns to the home position again.

※After the sample is cut, if you want the transfer unit to return to its home position immediately, press **START** button.

※In case either the cutting mode/ grinding mode is activated:

- Press **START** button → Only the selected mode is done.

### CAUTION

- Do not press **START** button to return the transfer unit to its home position when the terminal has not been completely cut apart yet.

- In case only the grinding mode is activated, be sure the the terminal is already cut. Otherwise, it may cause damage to CS07.

- When cutting the terminal again, make sure to bring the terminal forward - **at least 1mm** (higher). This is to protect the cutting disc from damage.

## 4.5 GRINDING THE TERMINALS

The following procedures describe the grinding operation, applied when only the grinding mode is activated.

Standard

10 / 16

2 / 16

Select mode.  
Push start button.

CS07  
Ver 1.03

1. Place the clamp on the transfer unit. Close the safety cover.

On operation screen, only activate the grinding mode.

: Activated

: Deactivated

Touch the buttons to activate/ deactivate them.



Press **START** button  
 → CS07 will move the terminal to the right and grind the terminal surface.  
 When it is complete, the transfer unit will automatically return to its home position.

※While grinding the terminal, if you want the transfer unit to return to its home position immediately, press **START** button.

### CAUTION

- Do not grind the terminal if it has not been cut yet. It may cause serious damage to the device.
- When grinding the sample surface again, only move the clamp to the front **0.2mm or less each time**.  
 Moving the terminal more than 0.2mm upward each time may cause damage to the device.

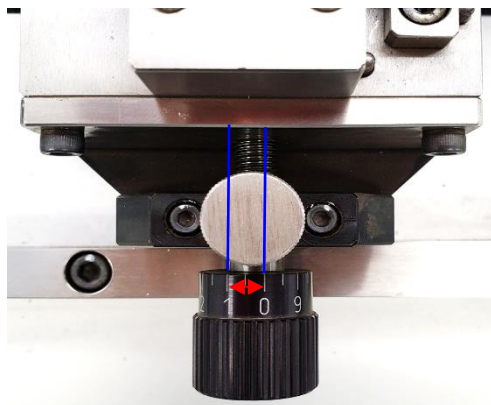

Each step = 0.1mm  
 e.g: 0~1 = + 0.1mm  
 0~2 = + 0.2mm  
 0~3 = + 0.3mm

## 4.6 TAKING CROSS SECTION PHOTOS

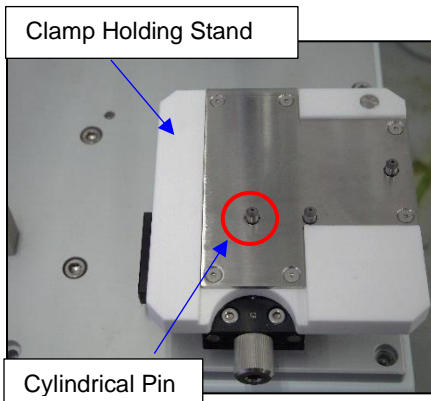

After the terminal returns to its home position, open the safety cover.

1. Take the clamp out.
2. Place it on the clamp holding stand.  
Align the clamp fitting hole with the cylindrical pin

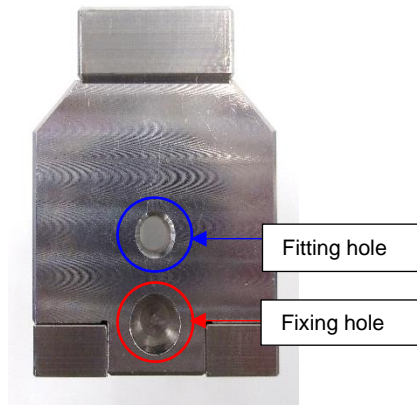

※Each type of clamp is designed to have 2 holes on its body:

- **Fixing hole:** Used when placing the clamp on the transfer unit.
- **Fitting hole:** Used when placing the clamp on the clamp holding stand.

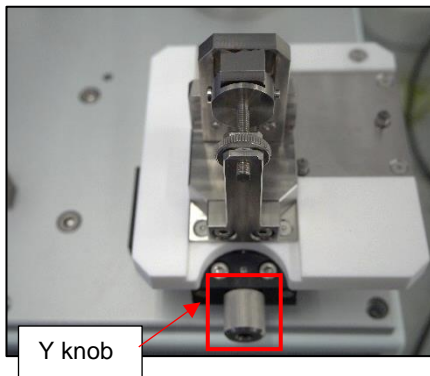

3. Adjust X and Y knobs so that the terminal cross section is at the center of the image.

- X knob: Move left and right
- Y knob: Move up and down

Adjustment range for X and Y knobs:  $\pm 7.5\text{mm}$ .

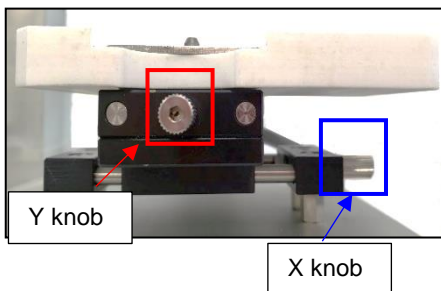

4. Adjust the camera focus.

5. Start etching the surface.
6. Take a cross section photo.

## 5 REPLACING & CLEANING CONSUMABLES

### 5.1 REPLACING THE CUTTING WHEEL

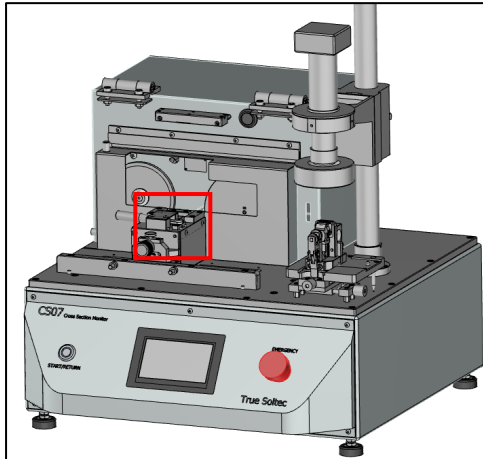

1. Remove the clamp from the transfer unit.  
Close the safety cover

On LCD operation panel, press **Setting**



→ CS07 setting screen appears.



2. At **Slide Clamper**, press **Right** button.  
→ The transfer unit starts moving to the right.  
→ Turn off the power of CS07.

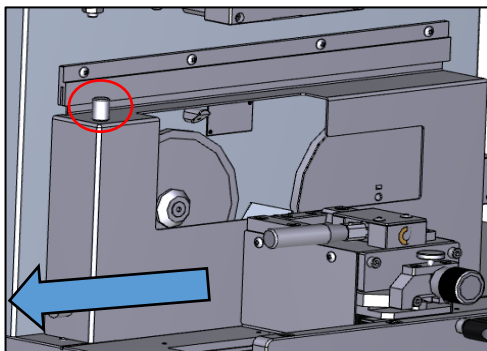

3. Open the metal protective cover by sliding it to the left while holding the metal knob (red circle).

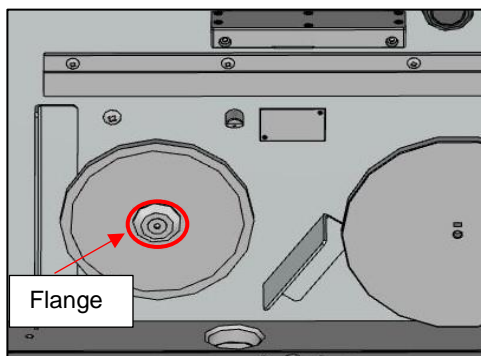

4. On the cutting side, remove the cutting wheel by rotating the flange **clockwise**.

※Do not rotate the flange counterclockwise.

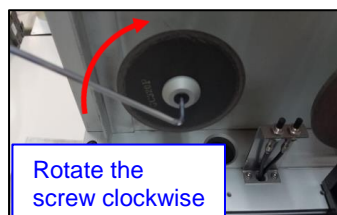

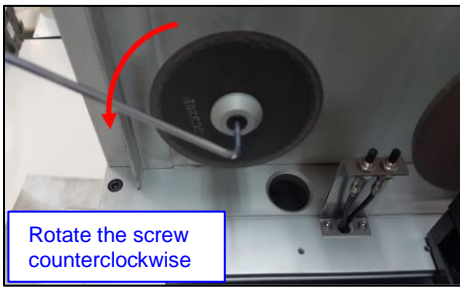

5. Replace the cutting wheel with a new one. Then, tighten the flange again by rotating it **counterclockwise**.

※This is a reverse screw.

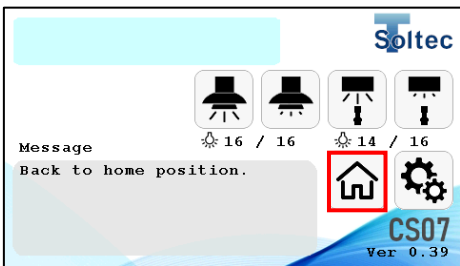

6. Return the metal protective cover to its original location.

→ Turn on the power of CS07.

→ Press **HOME** button to move the transfer unit to its home position.

Setting is completed.

## 5.2 REPLACING THE SANDPAPER

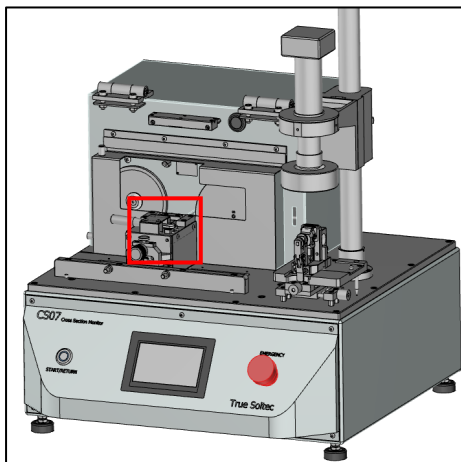

1. Remove the clamp from the transfer unit. Close the safety cover

On LCD operation panel, press **Setting**



button.

→ CS07 setting screen appears.



2. At **Slide Clamper**, press **Left** button.

→ The transfer unit starts moving to the left.

→ Turn off the power of CS07.

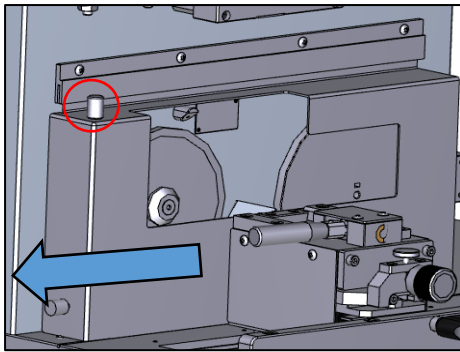

3. Open the metal protective cover by sliding it to the left while holding the metal knob (red circle).

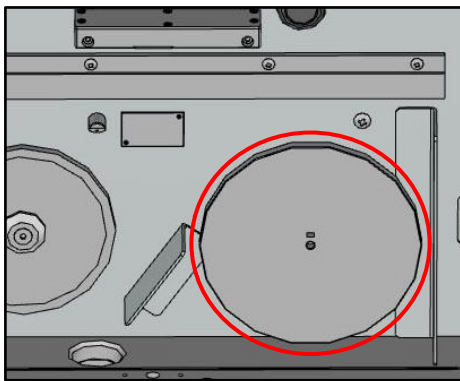

4. Peel off the sand paper from the grinding wheel. Use sticker removers or similar tools to clean and remove the remaining glue completely.

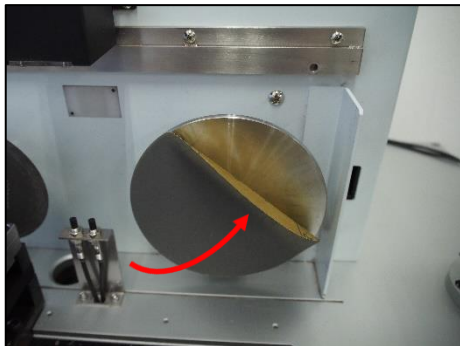

5. Firmly attach a new sandpaper to the grinding disc so that there are no wrinkles and no part can curl off.

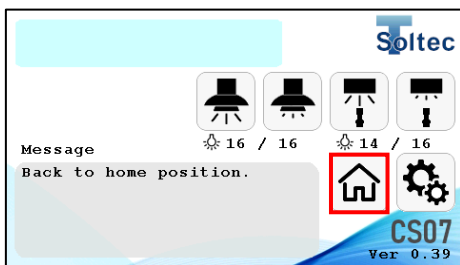

6. Return the metal protective cover to its original location.  
 → Turn on the power of CS07.  
 → Press **HOME** button to move the transfer unit to its home position.

Setting is completed.

### 5.3 CLEANING THE INTERNAL CUTTING AREA

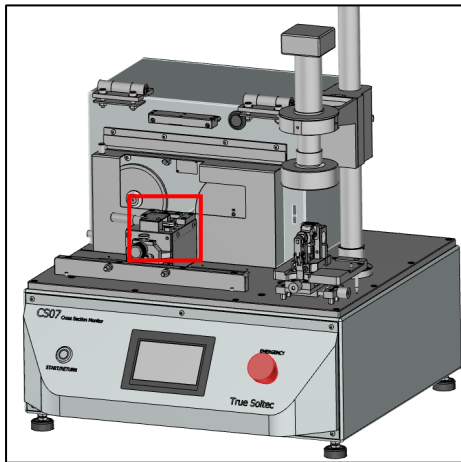

1. Remove the clamp from the transfer unit.  
Close the safety cover

On LCD operation panel, press **Setting** button.  
→ CS07 setting screen appears.



2. At **Slide Clamper**, press **Right** button.  
→ The transfer unit starts moving to the right.  
→ Turn off the power of CS07.

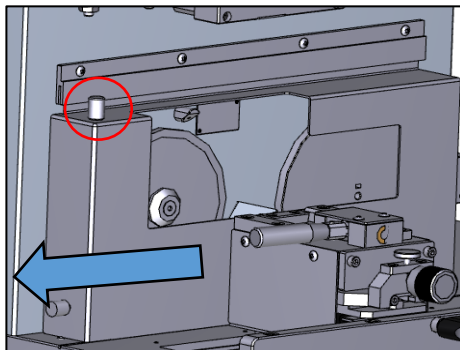

3. Open the metal protective cover by sliding it to the left while holding the metal knob (red circle).  
→ Use a brush or similar tools to wipe all the cutting dust into the hole below the cutting wheel.

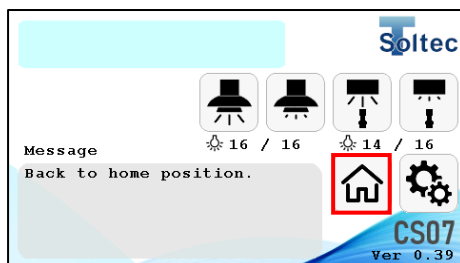

4. After cleaning the cutting area, return the metal protective cover to its original location.  
→ Turn on the power of CS07.  
→ Press **HOME** button to move the transfer unit to its home position.

Setting is completed.



Do not let any metal objects fall into the black brush area under the clamp transfer unit.



## 5.4 DISPOSING THE CUTTING DEBRIS

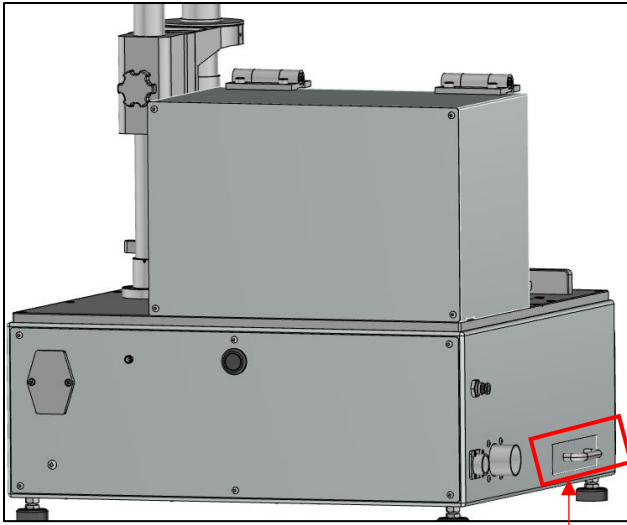

After cutting the terminals, their matting sections will fall into the metal debris tray.

Please clean this tray periodically (once a day if possible).

Metal Debris Tray

## 5.5 FUSE EXCHANGE



Remove the power cable.



Take out the fuse holder.



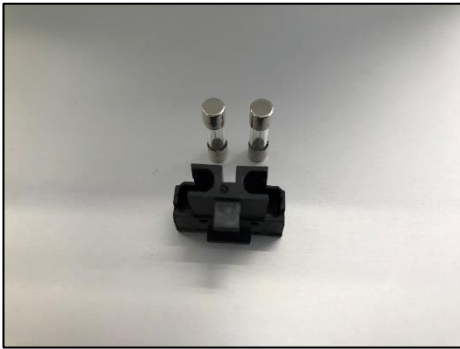

Take out the fuse from the holder.



Attach the new fuses and return them to the power unit.



## 6 TROUBLE SHOOTING

TROUBLE	POSSIBLE CAUSES & COUNTERMEASUREMENT	OTHER CAUSES & COUNTERMEASUREMENTS
Cutting disc or grinding wheel stop working.	<ul style="list-style-type: none"> <li>● Check the power of CS07</li> <li>● On LCD operation panel, check if the cutting/ grinding mode is activated (Green means activated)</li> <li>● Press <b>HOME</b> button</li> <li>● Check if the clamp is placed correctly. Then, press <b>START</b> button</li> </ul>	<ul style="list-style-type: none"> <li>● The motor, power supply, or <b>START</b> button may be broken.</li> </ul> <p>Please contact us or our local sales agencies for inspection.</p>
Strange noise appears.	Remove the cutting disc. Check if there are any foreign objects get caught. It is quiet when rotating with no load. Place the clamp with no terminal on CS07, press <b>START</b> button and check if there is any abnormal noise.	Please contact us or our local sales agencies for inspection.
The cutting wheel is loose.	Remove the cutting wheel flange and check if the cutting disc is installed correctly.	The axis of the motor may have trouble.  Please contact us or our local sales agencies for inspection.
The grinding disc is loose.	-	The grinding part may be damaged or deformed. Please contact us or our local sales agencies for inspection.
Strange smell appears.	-	Stop using the equipment immediately. Please contact us or our local sales agencies for inspection.
The <b>START</b> button is broken.	-	Stop using the equipment. Please contact us or our local sales agencies for inspection.
The clamp cannot set on the clamp transfer unit.	Check if there are any foreign objects on the clamp transfer unit.  If the transfer unit is rusted/ dirty, use a sandpaper to clean it.  Check if there are any parts misaligned or loose.	The clamp may be deformed.  Please contact us or our local sales agencies for inspection.
The terminal surface is not clean after grinding.	Check if there are any foreign protrusions on the surface of the sandpaper.	Replace the sandpaper.

After grinding, the terminal surface is burnt	Check if there are any foreign protrusions on the sandpaper's surface.	Replace the sandpaper.
The clamp is ground/cut.	Make sure the clamp and its screws are not loose. Check if there is abnormality with the transfer unit.	Please contact us or our local sales agencies.
The camera stops working.	If you recently upgrade your windows version or replace/ change your computer, reinstall the camera driver.  Check if the camera is correctly recognized via Windows device manager.	The camera may be broken.  If you have recently updated your windows, the camera may not be compatible with the new windows.  Please contact us or our local sales agencies.
LED is not bright enough. (The photo appears quite dark)	On the LCD operation panel, check the LED brightness. → Increase the brightness if necessary.  Check the LED power cable if it is connected properly or not.	The LED or its power supply may be broken.  Use a tester to check if the voltage is output at the AC jack of the LED. If the voltage is output, the lights on the LED may be broken.  Please contact us or our local sales agencies for inspection.
The LED keeps blinking. (It goes on and off)	<ul style="list-style-type: none"> <li>● Check the LED power cable(s) if it is properly connected.</li> <li>● Check if the power supply to the CS07 is stable. The LED may turn on and off if the power is not stable.</li> </ul>	If the LED blinks when you touch the power cable, there may be a problem with the cable or the AC jack.  If the LED blinks even there is no impact, the power supply may be unstable or there may be poor contact due to the power supply.  Please contact us or our local sales agencies for inspection.
Photos are blurry.	Gently clean the camera and lens with a clean and soft cloth.	The lens surface may have been burnt. Replace your lens. Please do not place the lens too close to the terminal while etching.
X and Y knobs at the clamp holding stand, do not move	-	The internal gear screws may be broken. The clamp holding stand need to be replaced/ repaired.  Please contact us or our local sales agencies.

## 7 BIG WIRE CROSS SECTION

With CS07 big-wire cutting option, it is possible to cut up to 60sq terminals (Length: 14mm or less, Width: 20mm or less).

Cross sections of big wires are very clean and clear, even without grinding.

CS07 automatically recognizes and switches to big-wire cutting mode based on the clamp placed on the transfer unit.

**Applicable wire range: AWG10 ~ AWG1/0**

※Distance from the cutting and grinding wheel to CS07 cover: 30mm.

If the terminal mating section is longer than that, please cut it off before operation.

### 7.1 BIG WIRE CUTTING OPTIONAL COMPONENTS

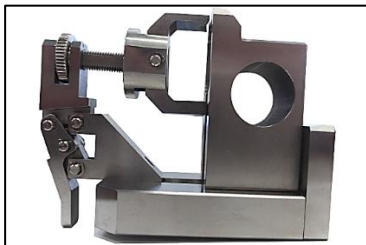

Big wire clamp



Coin type washer



Vacuum Unit



0.5X auxiliary lens

## 7.2 INSTALLING THE VACUUM DEVICE

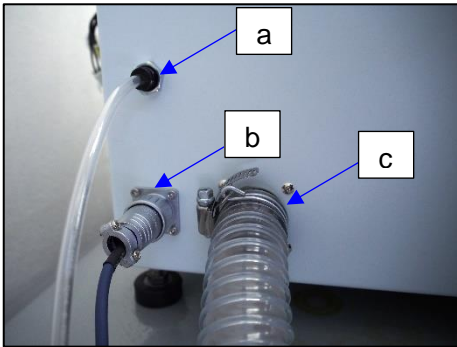

1. On the left side of CS07, connect the following items to the main unit:

- a. Air tube
- b. Power cable for vacuum unit
- c. Duct hose

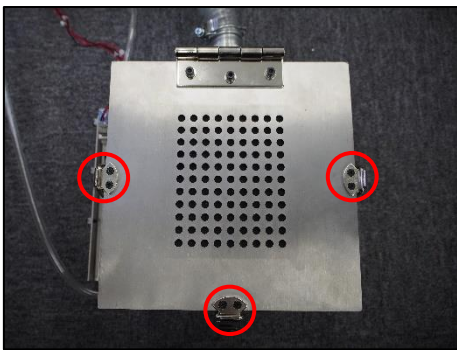

2. Open the vacuum unit by unlocking 3pcs individual locks (red circles)

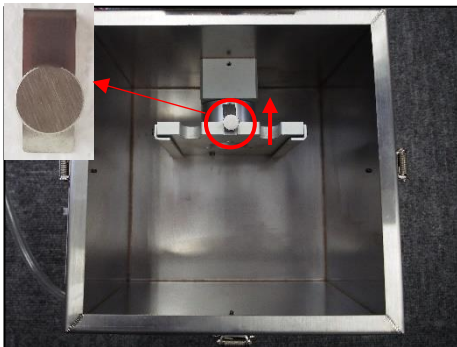

3. Loosen the screw (red circle).  
Then, pull the metal plate up (red arrow)



4. Slide the vacuum bag into the slot.

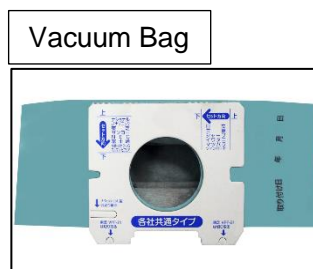

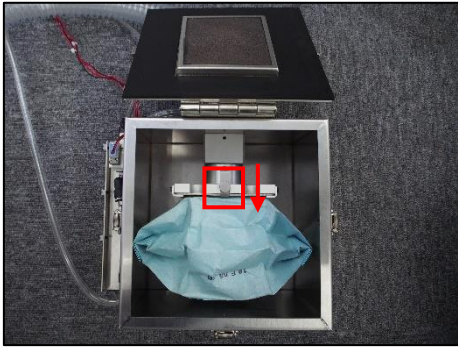

5. Return the metal plate to its original location.  
→ Tighten the screw to fix the bag.

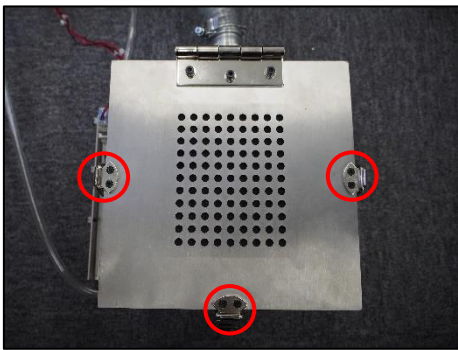

6. Close the vacuum box and lock it again.

 **CAUTION** ←

- Place the vacuum box at well-ventilated locations.
- Do not block the air vent of the vacuum box.

### 7.3 INSTALLING THE AUXILIARY LENS



It is possible to attach the auxiliary lens to the camera without removing the LED.



Prepare the 0.5X auxiliary lens.



Rotate the auxiliary lens clockwise to attach it to the camera.

#### CAUTION

- Camera working distance will become longer after installing the auxiliary lens. It is necessary to raise the camera up, further from the cross-section surfaces.
  - Loosen the screw on the back of the camera unit.
  - Hold the camera firmly while raising it up.
  - Tighten the screw firmly.



## 7.4 SETTING THE TERMINALS

The following procedures describe how to place the large crimps into the clamp.

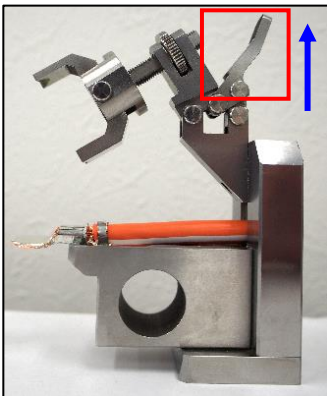
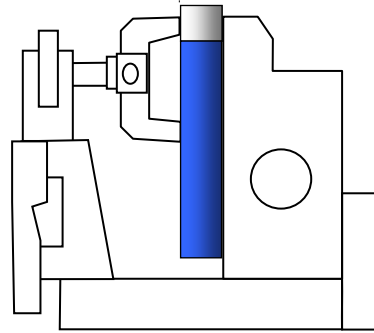
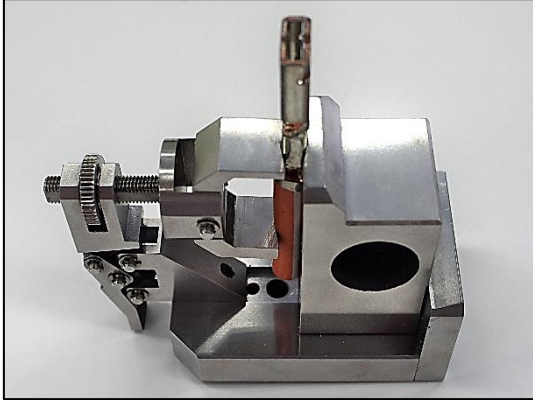

1. Pull the clamp lever up (red frame).

2. Place the sample into the V groove of the clamp. The terminal should be vertical (above photo), not bending to the left/ right or up/ down.

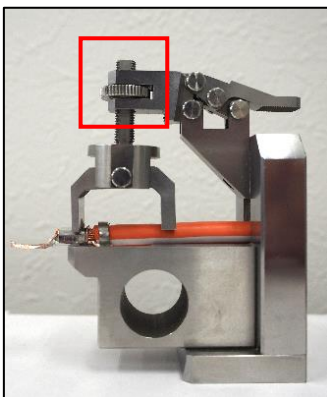

3. Push the lever down. Rotate the screw clockwise to tighten the crimp firmly.

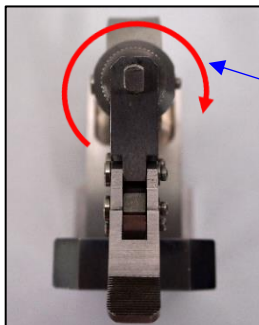

Rotate the screw clockwise

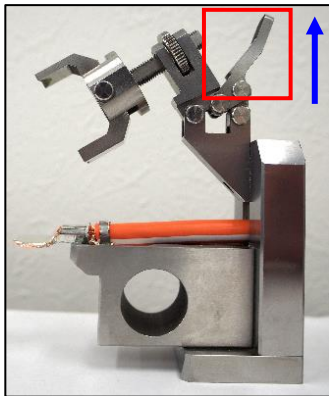

4. Next, pull the lever up again.  
Rotate the screw clockwise one more time - about half of a round (Max: 1 round only).

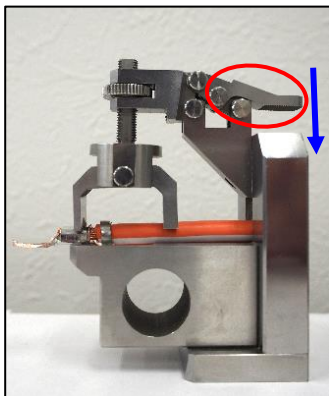

4. Finally, press the lever down again.  
You will hear a slightly "tick". This means the crimp is completely tightened. Check the terminal again to see if it is stable or not.

※When pressing the lever down, it may require a little force.  
The more you rotate the screw at step 4, the more force you have to use to push it down.  
Therefore, do not rotate the screw too much.

\* 下図のように端子が跳ね上がってしまう場合は付属のコイン型ワッシャーの治具をクランパー下部にセットして保持してください。

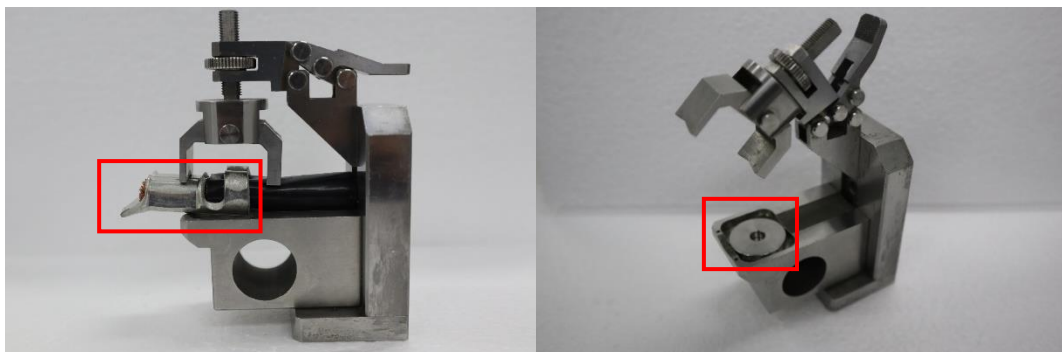

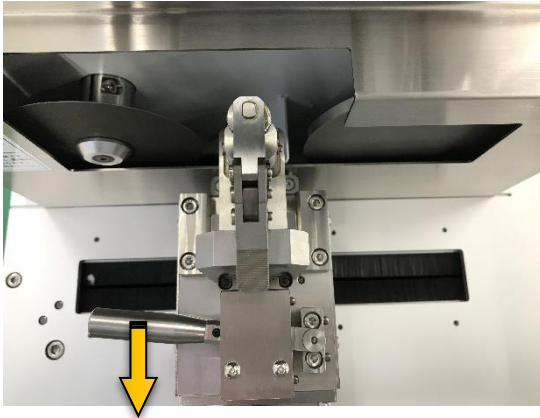

**At Clamp Transfer Unit:**

- Pull the lever down
- Place the clamp on the transfer unit.
- Release the lever.

6. Change the cutting position if necessary. Refer to [4.2 Adjusting the cutting position](#) (page 12) for details.

7. Close the safety cover.

**NOTE:**

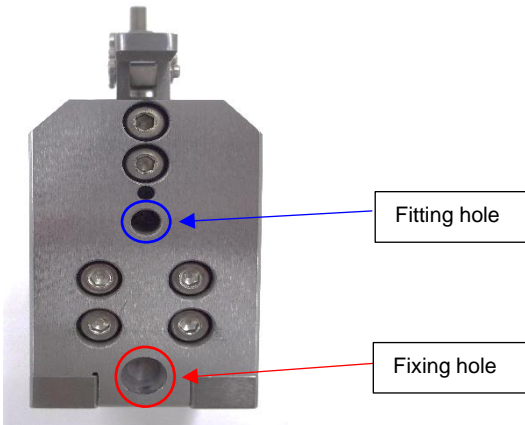

※Each type of clamp is designed to have 2 holes on its body:

- **Fixing hole:** Used when placing the clamp on the transfer unit.
- **Fitting hole:** Used when placing the clamp on the clamp holding stand.

Applicable wire AWG10 ~ AWG1/0  
 Wire max. protruding length from the clamp surface: Less than 30mm  
 (Cut off the wire tip if it is more than 30mm)

## 7.5 CUTTING THE BIG WIRES

Cutting big terminals will produce a large amount of metal dust. Therefore, it is necessary to activate the vacuum cleaner.

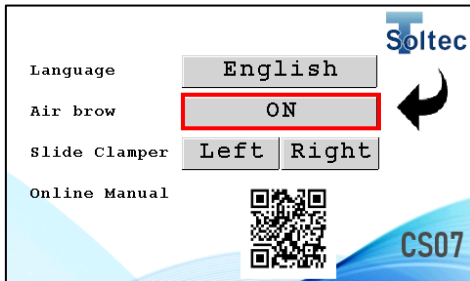

1. On LCD operation panel, select **Setting** button. 
  - Setting screen appears

At **Air brow**, touch **OFF** button  
 → It will switch to **ON**

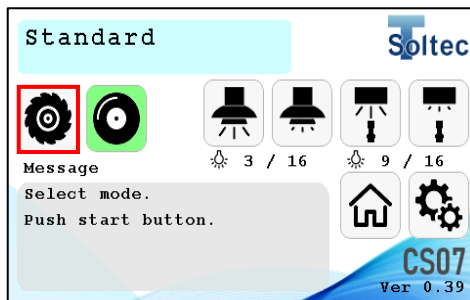

2. On the LCD panel, big wire cutting mode (Large) is automatically recognized. Check if cutting mode is activated or not.

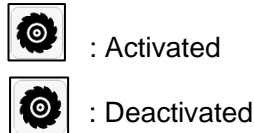

If the cutting mode is not activated, touch **Cutting** button  
 → It will switch to green (activated)



3. Press **START** button  
 → CS07 automatically cuts the terminal. When the transfer unit reaches its leftmost limit, it will then return to its home position.

※After the terminal is cut, if you want the transfer unit to return to its home position immediately, press **START** button.

## 7.6 TAKING CROSS SECTION PHOTOS

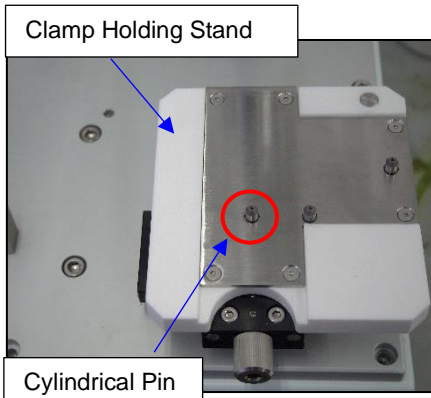

After the terminal returns to its home position, open the safety cover.

1. Take the clamp out
2. Place it on the clamp holding stand.

→ Align the clamp fitting hole with the cylindrical pin.

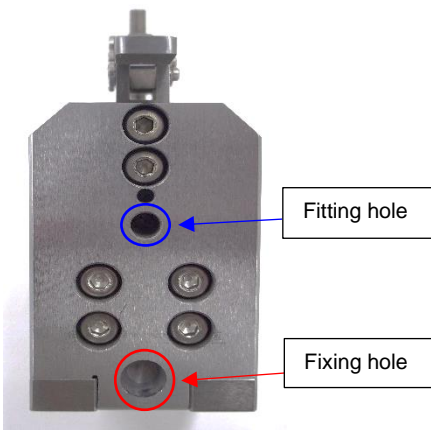

※Each type of clamp is designed to have 2 holes on its body:

- **Fixing hole:** Used when placing the clamp on the transfer unit.
- **Fitting hole:** Used when placing the clamp on the clamp holding stand.

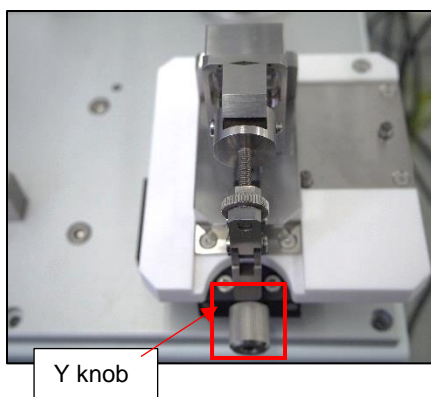

3. Adjust X and Y knobs so that the terminal cross section is at the center of the image.

- X knob: Move left and right
- Y knob: Move up and down

Adjustment range for X and Y knobs:  $\pm 7.5\text{mm}$ .

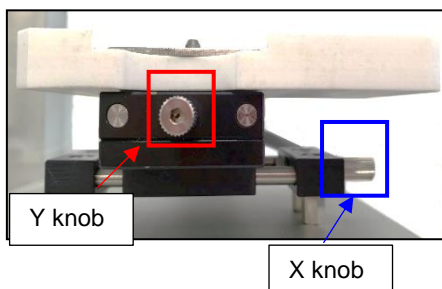

4. Change the camera focus.

5. Start etching the surface
6. Take a cross section photo.

## 7.7 CLEANING THE VACUUM UNIT

Each customer uses CS07 at a different frequency. For this reason, there is no specific instruction on how long a vacuum bag should be utilized.

We recommend you change the bag when the suction power becomes weak, or when the dust starts attaching to the safety cover.

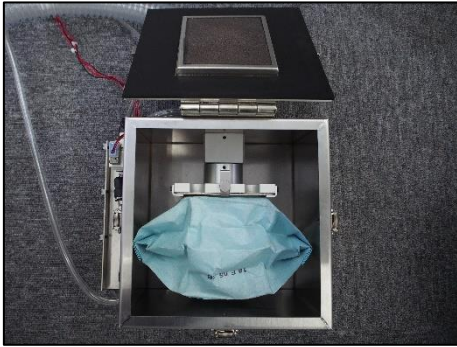

All the cutting dust will be stored in the vacuum bag inside the vacuum unit. Dispose this metal dust following your local guidelines and regulations.



1. Remove the vacuum bag by pulling it upward. Be careful not to squeeze the bag as it may make the metal dust flow outside.

2. Install a new vacuum bag. Refer to [7.2 Installing the vacuum unit](#) (page 25) for more details

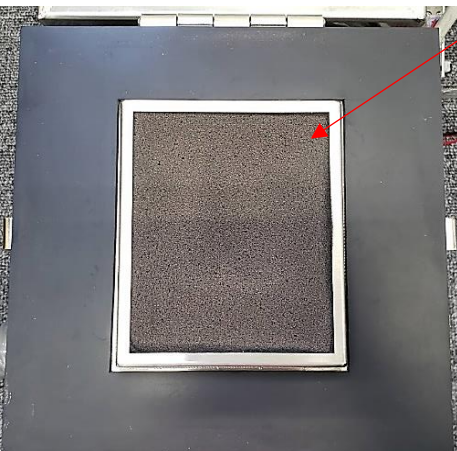

3. Remove the black sponge from the lid of the vacuum unit. Clean the sponge and return it back.

## 8 LONGITUDINAL CROSS SECTION

With CS07 longitudinal cutting option, it is very easy to create a longitudinal cross section. All terminals that have their total length up to **5mm**, can be used with CS07 optional gigs. CS07 automatically recognizes and switches to the longitudinal cutting mode based on the type of clamp that is being used.

At longitudinal cutting mode, operator manually moves the terminal close to the grinding wheel via controlling the LCD panel. The terminal is ground a little at a time until it reaches the measuring position.

### 8.1 LONGITUDINAL CROSS SECTION OPTIONAL COMPONENTS

1. Longitudinal cross section clamp

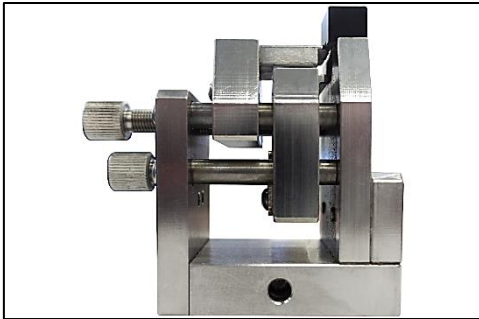

2. Longitudinal cross section grinding wheel  
Thickness: 5mm



3. Longitudinal cross section wheel bearing



## 8.2 ASSEMBLING THE GRINDING WHEEL

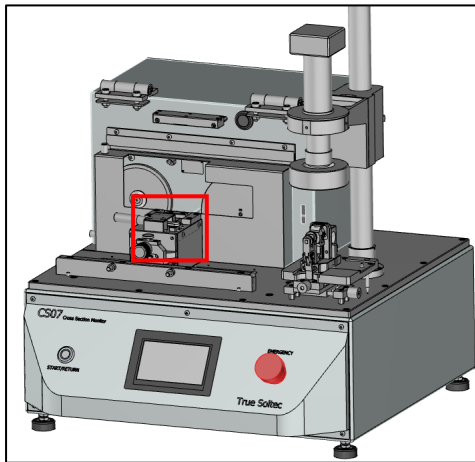

1. Remove the clamp from the transfer unit.  
Close the safety cover.

On LCD operation panel, select **Setting** button.  
→ CS07 setting screen appears



2. At **Slide Clamper**, select **Right** button  
→ The transfer unit will move to the right.  
→ Turn off the power of CS07.

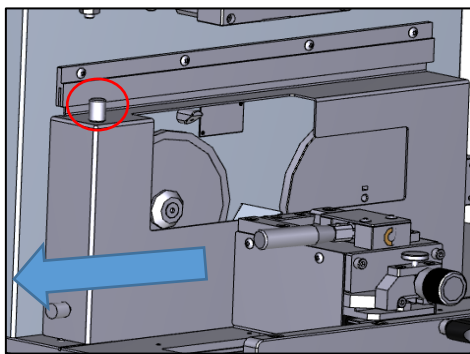

3. Open the metal protective cover by sliding it to the left while holding the metal knob (red circle)

4. On the cutting side, remove the standard cutting wheel by rotating the flange **clockwise**.  
**✘Do not rotate the flange counterclockwise.**

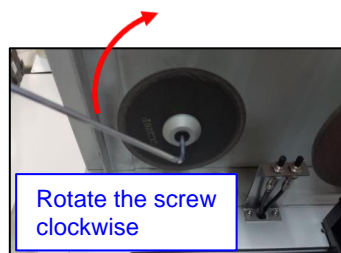
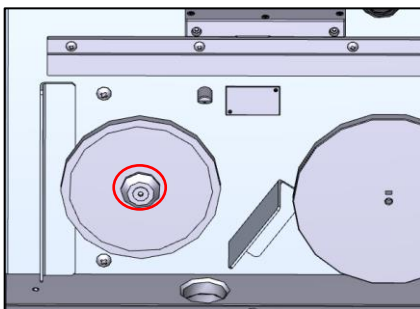





5. Remove the wheel bearing of the standard cutting disc.



6. Mount the wheel bearing of the longitudinal cutting disc.



7. Place the cutting wheel to the arbor. Then, mount the flange to the wheel firmly by rotating the screw **counterclockwise**.

※This is a reverse screw.

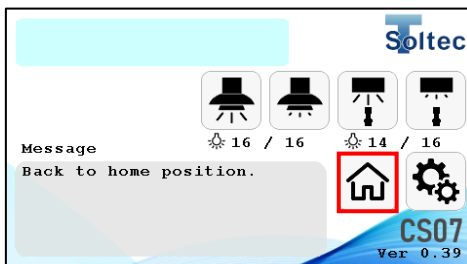

8. Return the metal protective cover to its original location.

→ Turn on the power of CS07.

→ Press **HOME**  button to move the transfer unit to its home position.

Setting is completed.

### 8.3 SETTING THE TERMINALS

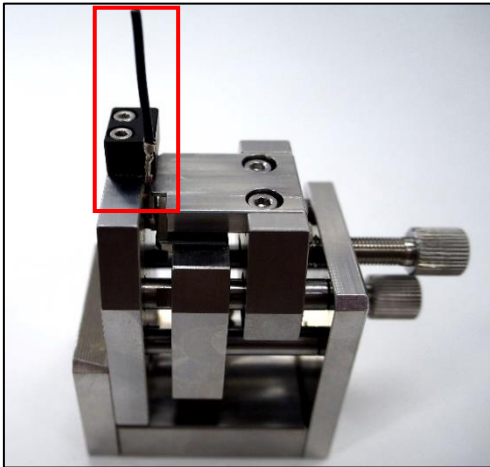

1. Place the terminal mating section into the clamp tightening bracket. Ensure the terminal is set straight and leans back on the fixing block (black). This block will prevent the terminal from bending during the grinding process.

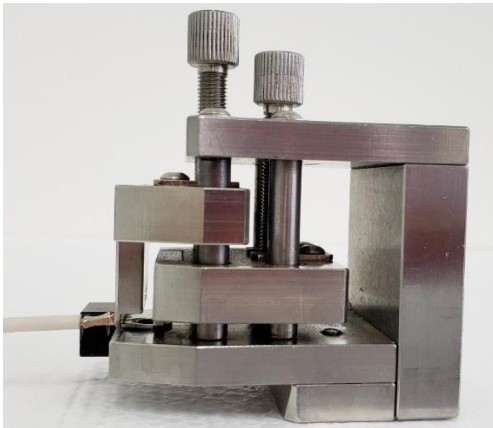
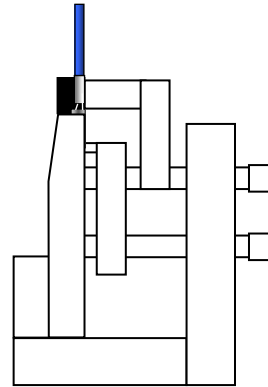

2. Longitudinal cutting clamp is designed to hold the terminal mating section at two positions. Ensure the mating section is hold firmly at these positions

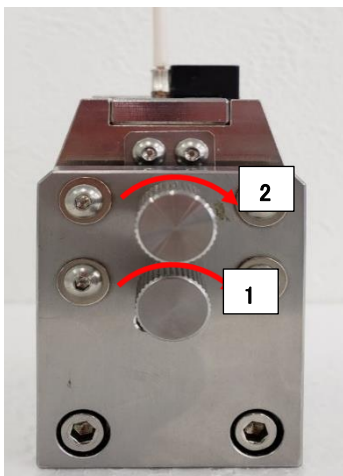
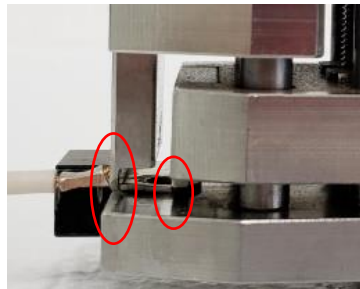

3. Rotate screw clockwise to tighten the terminal.

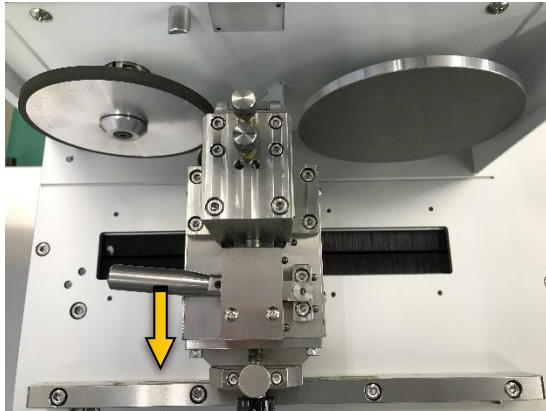

4. Pull the level down  
 → Place the clamp on the transfer unit.  
 Align the clamp fixing hole with the cylindrical pin.  
 → Release the lever.

Grinding wheel thickness: 5mm  
 Wire barrel total length: 5mm or less

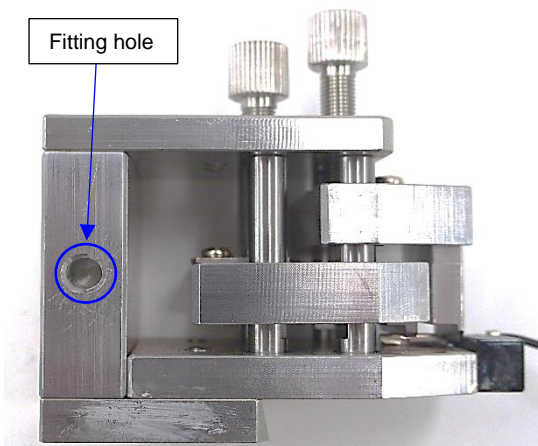

- ※Each clamp has 2 holes on its body:
- **Fixing hole:** Used when placing the clamps on the transfer unit.
  - **Fitting hole:** Used when placing the clamps on the clamp holding stand.



5. Adjust the cutting position.  
 → The conductive barrel should be within the range of the grinding wheel's thickness.  
 ※Refer to [4.2 Adjusting the cutting position](#) (page 12) and CS07HI operation manual for details.

## 8.4 GRINDING THE TERMINALS

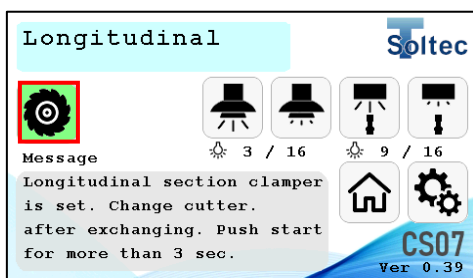

1. On the LCD operation panel, longitudinal grinding mode (Longitudinal) is automatically recognized.

Check if the cutting button is activated.



Activated



Deactivated

If it is not activated, touch the **Cutting**  Button → It will switch to green (activated)



2. Press **START** button.

※After changing the grinding wheel, press and

hold **START** button for approx. 3 seconds or

longer to activate the longitudinal cutting mode.

From the 2<sup>nd</sup> time, you only need to press **START** button.

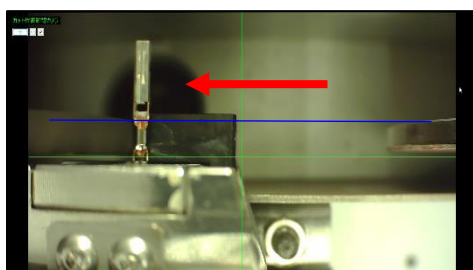

3. The terminal will move a certain distance to the left, while the grinding wheel starts rotating.

At this position, operators will control the LCD screen to move the terminal close the wheel a little at a time.

Check the camera while moving the terminal:

a. Press and hold  button to move the terminal close to the grinding wheel

b. When the terminal is about touching the wheel, release the button.

c. Next, press  button once at a time.

Each time pressing this button, CS07 will move the terminal a certain distance to the left.

※This distance is displayed below this button.

When the terminal starts touching the wheel, you will hear a grinding sound.

Wait until this sound disappears, then press  button again to move it further to the left. → The grinding sound appears again.

Wait until this sound disappears before pressing the  button again. Keep doing it until it reaches the measuring position.

## BUTTON DESCRIPTIONS:

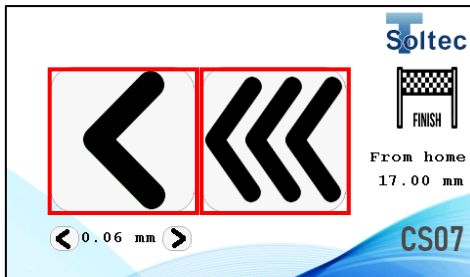

Move the terminals to the left continuously when you press this button.



Move the terminals a certain distance to the left each time you press it (one step at a time).

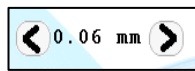

The moving range that the terminal will move each time you press the  button.

Setting range: 0.02 ~ 0.1mm



5. After finishing, select **FINISH** button.

→ The transfer unit returns to the home position.

Grinding is complete.

## 8.5 TAKING CROSS SECTION PHOTOS

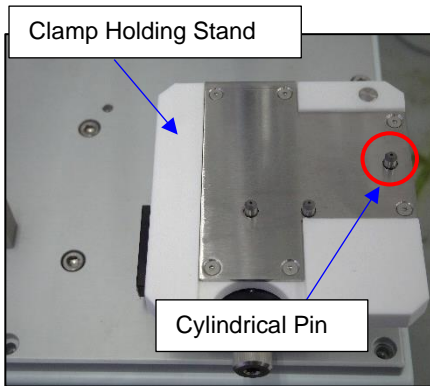

After the terminal returns to its home position, open the safety cover.

1. Take the clamp out.
2. Place it on the clamp holding stand.  
Align the clamp fitting hole with the cylindrical pin.

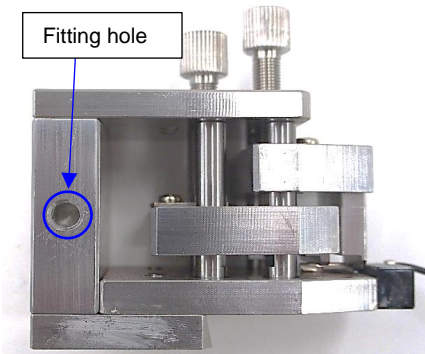

※Each clamp has 2 holes on its body:

- **Fixing hole:** Used when placing the clamps on the transfer unit.
- **Fitting hole:** Used when placing the clamps on the clamp holding stand.

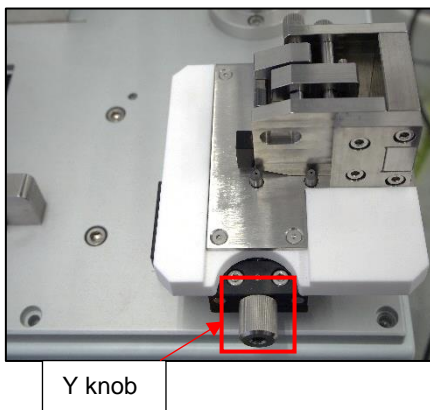

3. Adjust X and Y knobs so that the terminal cross section is at the center of the image.

- X knob: Move left and right
- Y knob: Move up and down

Adjustment range for X and Y knobs:  $\pm 7.5\text{mm}$ .

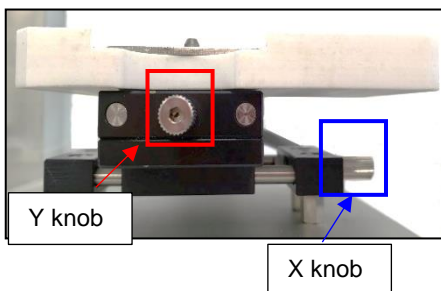

4. Adjust the camera focus.

5. Start etching the surface.
6. Take a cross section photo.

## 9 SPECIFICATIONS

### 9.1 CS07 SPECIFICATIONS

		Description
Cutting	Wire range	Standard cutting 5sq
		Big-wire cutting 60sq (Length: 14mm or less      Width: 20mm or less)
	Type	Dry
	Cutting disc (Standard & Big-wire cutting)	φ90      Thickness 0.5mm
		Longitudinal φ100      Thickness: 5mm
	Motor	120W
Rotation	Clockwise	
Grinding	Wire range	5sq
	Type	Dry
	Sandpaper	#1200 grain size      Sticker replacement
	Motor	120W
	Rotation	Clockwise
Air pressure (optional)	0.5Mpa	
Operating Temperature	5 ~ 40°C	
Humidity	0 ~ 90 % RH (No dew, no condensation)	
Dimensions	W500 x D522 x H693mm	
Weight	Approx. 50kg	
Power	AC100V ~240V / 50 ~ 60Hz	
Power consumption	Approx. 135W (Maximum)	

### 9.2 STANDARD LENS SPECIFICATIONS

Magnification	0.7X ~ 0.45X								
WD	87mm ± 2mm								
Zoom	0.7X	1.0X	1.5X	2.0X	2.5X	3.0X	3.5X	4.0X	4.5X
DOF	1.9	0.952	0.44	0.29	0.23	0.16	0.13	0.12	0.1
Focus	11.18	7.99	5.59	4.79	4.79	3.95	3.95	3.95	3.95
FOV (D)	8.57	6.00	4.00	3.00	2.40	2.00	1.71	1.50	1.33
FOV (H)	6.86	4.80	3.20	2.40	1.92	1.60	1.37	1.20	1.07
FOV (V)	5.14	3.60	2.40	1.80	1.44	1.20	1.03	0.90	0.80
Mount	C type								

0.5X auxiliary lens (when cutting big wires)

Magnification	0.7X ~ 0.45X	
WD	163mm	
Zoom	0.7X	4.5X
FOV (L)	27.4	4.3
FOV (W)	20.6	3.2
Mount	C type	

### 9.3 CAMERA SPECIFICATIONS

Sensor size	1/2.9 "
Pixel size (μm)	3.45 × 3.45
FPS/Resolution	60/ 1440 × 1080
Operating temperature	0°C ~85°C
Storage temperature	-30°C ~60°C
Power	5 V (USB 3.1)
OS	Windows or Linux (32bit or 64bit)
USB port	USB3.0
Lens	C mount lens
Dimensions	27 mm × 27 mm × 14.5 mm

#### 9.4 CS07 DIMENSIONS

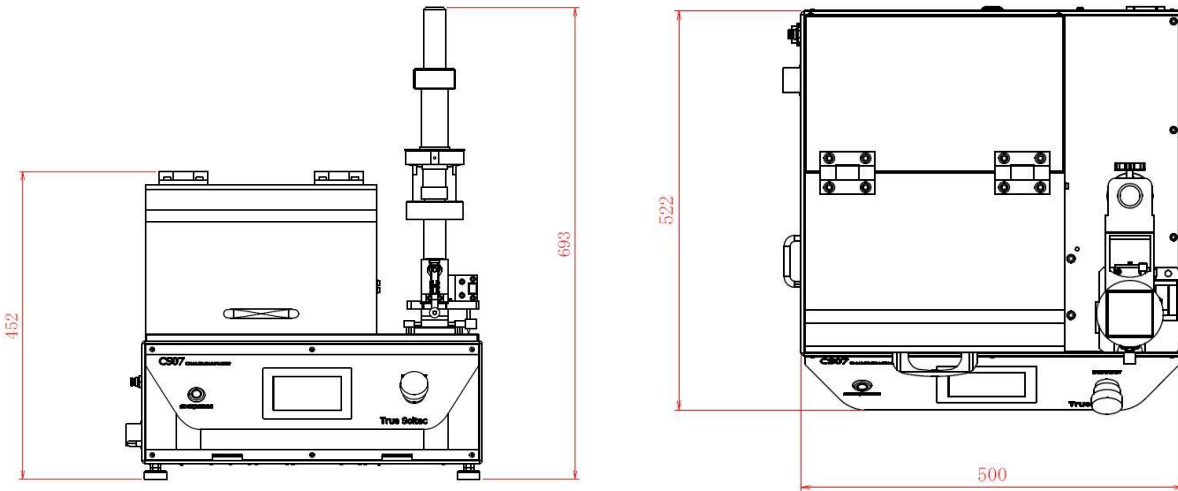



## 10 WARRANTY

### CONTACT US

Please contact our sales agency or contact us via the following phone/ email address for a repair or other services.

TEL: 049-242-9184

FAX: 049-242-3190

E-mail: [info@truesoltec.co.jp](mailto:info@truesoltec.co.jp)

When requesting for a repair, please mention the following information:

Product	
Model	
Date of purchase	
Trouble Details	Please described in as much detail as possible
Address	
Company	
Contact Person	
TEL	

### WARRANTY

1. The warranty period is 1 (one) year from the date of purchase.
2. If the failures are caused by reasons attributing to product design or production problems, they will be covered by the warranty. However, if the failures are caused by reasons attributing to customers such as improper operation, they are not covered by the warranty even if it is still within the warranty period. True Soltec shall make the judgement.

Example:

- Caused by improper operation, or by service modifications or repairs performed by personnel not authorized by True Soltec.
  - Caused by fire, earthquake, storm or flood, lightning, and other natural disasters, or external causes.
  - Caused by using power supply out of rated or abnormal power source.
  - Caused by drops or vibrations, or other improper usage.
3. If it is out of warranty period, customers shall bear all the repairing charge.

TRUE SOLTEC CO., LTD  
Suna 906-5, Kawagoe-city, Saitama 350-1133 Japan  
TEL 049-242-9184  
FAX 049-242-3190  
URL <http://www.truesoltec.co.jp/>  
E-mail [info@truesoltec.co.jp](mailto:info@truesoltec.co.jp)