



PCE Americas Inc.
711 Commerce Way
Suite 8
Jupiter
FL-33458
USA
From outside US: +1
Tel: (561) 320-9162
Fax: (561) 320-9176
info@pce-americas.com

PCE Instruments UK Ltd.
Units 12/13
Southpoint Business Park
Ensign way
Hampshire / Southampton
United Kingdom, SO31 4RF
From outside UK: +44
Tel: (0) 2380 98703 0
Fax: (0) 2380 98703 9
info@pce-instruments.com

www.pce-instruments.com/english
www.pce-instruments.com



User Manual

Inspection Camera

PCE-DHM 10

Table of Contents

EN

1.	Precaution.....	2
2.	Preparation.....	6
	● Standard Accessories.....	6
	● Part Names & Functions.....	7
3.	key features.....	8
4.	Use the Microscope.....	9
	● Install Battery.....	9
	● Insert a MicroSD Card.....	10
	● Display Icons & Meanings.....	11
	● Turn on the Microscope.....	12
	● Turn off the Microscope.....	12
	● How to Capture.....	13
	● Download to Computer.....	19
	● Preview on Computer.....	19
	● Charge Battery.....	20
	● Connect to TV.....	21
	● Mount Tripod.....	22
5.	Menu Introductions.....	23
	● Set Resolution.....	23
	● Timer.....	24
	● Quality.....	25
	● Sharpness.....	27
	● Language.....	27
	● Power Save.....	27
	● Frequency.....	28
	● Date Stamp.....	28
	● TV out.....	29
	● Date/Time.....	29
	● Format SD.....	30
	● System Reset.....	30

●	Version.....	30
6.	Specifications.....	31
7.	Computer System Minimum Requirement.....	31
8.	Troubleshooting.....	32

PortablCapture Software Introductions.....33

1.	Install Software.....	34
2.	Start Microscope.....	35
3.	Software Introductions.....	36
●	Preview size.....	36
●	Rotate Image.....	37
●	Date/Time.....	37
●	Language.....	38
●	Full Screen.....	38
●	Capture.....	40
●	Edit Photos.....	41
●	Edit Video.....	43
●	Quit PortableCapture	44
4.	Measurement.....	45
5.	PortableCapture for Mac.....	51
	Part I Install PortableCapture	51
	Part II Use PortableCapture	52
●	Preview.....	52
●	Date/Time.....	53
●	Photo Capture.....	54
●	Video Capture.....	55
●	Edit Photo/Video.....	56
●	Help.....	57
●	Quit.....	57

Welcome

Thank you for purchasing a Portable Digital Microscope. Please take a moment to read through this manual. Its contents will help you to get the best use of the smart microscope.

1. Precaution

Before using Portable Digital Microscope, please ensure that you read and understand the safety precautions described below. Always ensure that the Portable Digital Microscope is operated correctly.

- Never operate Portable Digital Microscope where operation of such devices is restricted. Improper use creates the risk of serious accident.
- Do not try to open the case of Portable Digital Microscope or attempt to modify Portable Digital Microscope in any way. Maintenance and repairs should be performed only by authorized service providers.
- Keep Portable Digital Microscope away from water and other liquids. Do not use Portable Digital Microscope with wet hands. Never use Portable Digital Microscope in the rain or snow. Moisture creates the danger of fire and electric shock.
- Keep Portable Digital Microscope and its accessories out of the reach of children and animals to prevent accidents or damage to the Portable Digital Microscope.

If you notice smoke or a strange odor coming from Portable Digital Microscope, turn the power off immediately. Take Portable Digital Microscope to the nearest authorized service center for repair. Never attempt to repair Portable Digital Microscope on your own.

- Portable Digital Microscope may become slightly warm during use. This does not indicate malfunction.
- If the exterior of Portable Digital Microscope needs cleaning, wipe it with a soft, dry cloth.

FCC Notice

EN

- This equipment has been tested and found to comply with the limits for a Class B digital device, pursuant to Part 15 of the FCC Rules. These limits are designed to provide reasonable protection against harmful interference in a residential installation.

CAUTION

To comply with the limits for a Class B digital device, pursuant to Part 15 of the FCC Rules, this device, when needed, must only be connected to computer equipment certified to comply with the Class B limits.

2. Preparation

■ Standard accessories

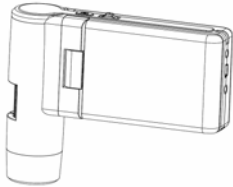

Portable Digital
Microscope

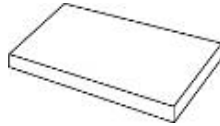

Lithium Battery

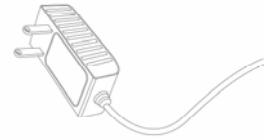

AC adaptor

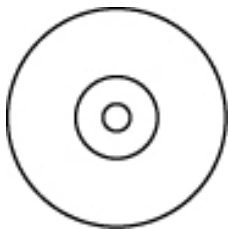

CD



USB cable



TV cable

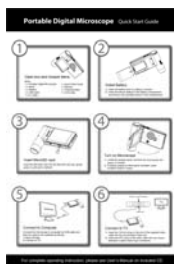

QSG

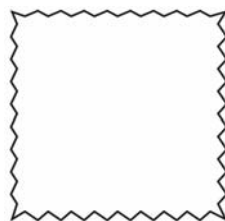

Cleaning fabric

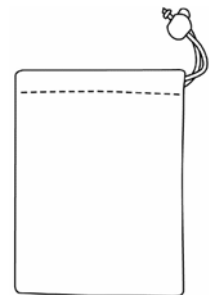

Carry bag



Stand



Strap

■ Parts Names & Functions

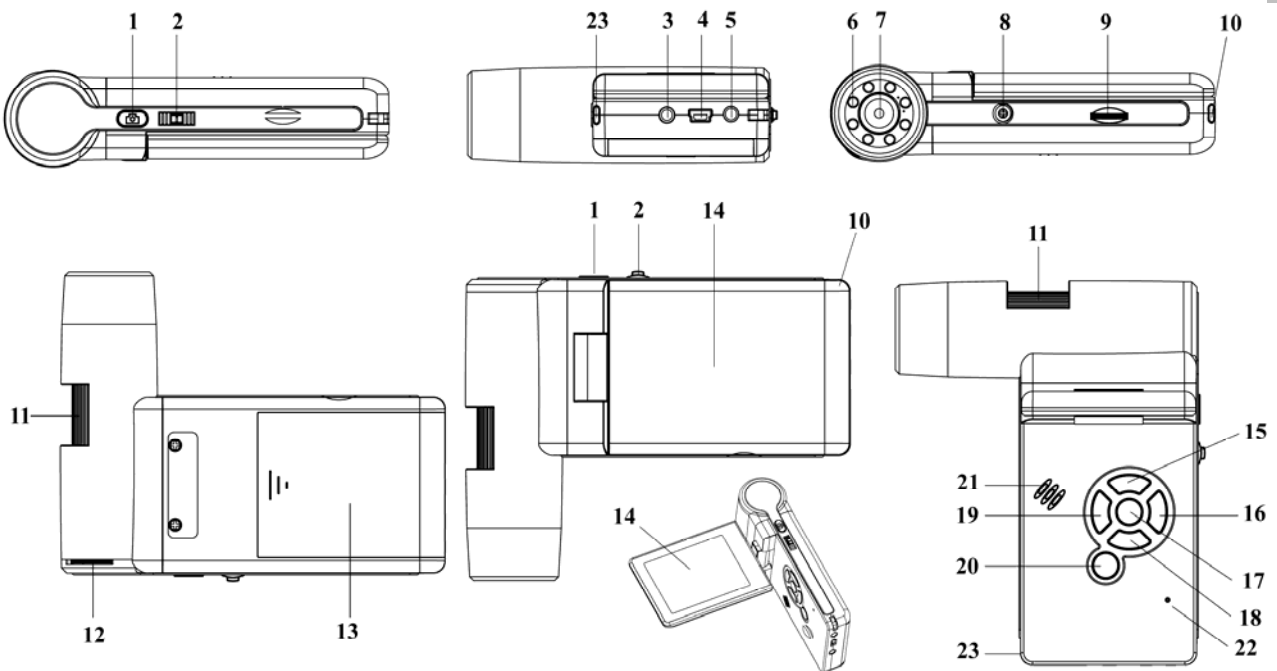

No.	Functions	No.	Functions
1	Capture	12	LEDs brightness dial
2	Zoom in/out; Screen icon display on/off	13	Battery compartment
3	TV-out	14	TFT display
4	USB port	15	UP Color mode switch
5	DC-in	16	Menu setup
6	Aux LEDs	17	OK
7	Lens	18	DOWN
8	Tripod mounting hold	19	LEFT / BACK
9	MicroSD card slot	20	Power on/off
10	Wrist grip hook	21	Speaker
11	Focus wheel	22	Microphone
23	Battery charging indicator		

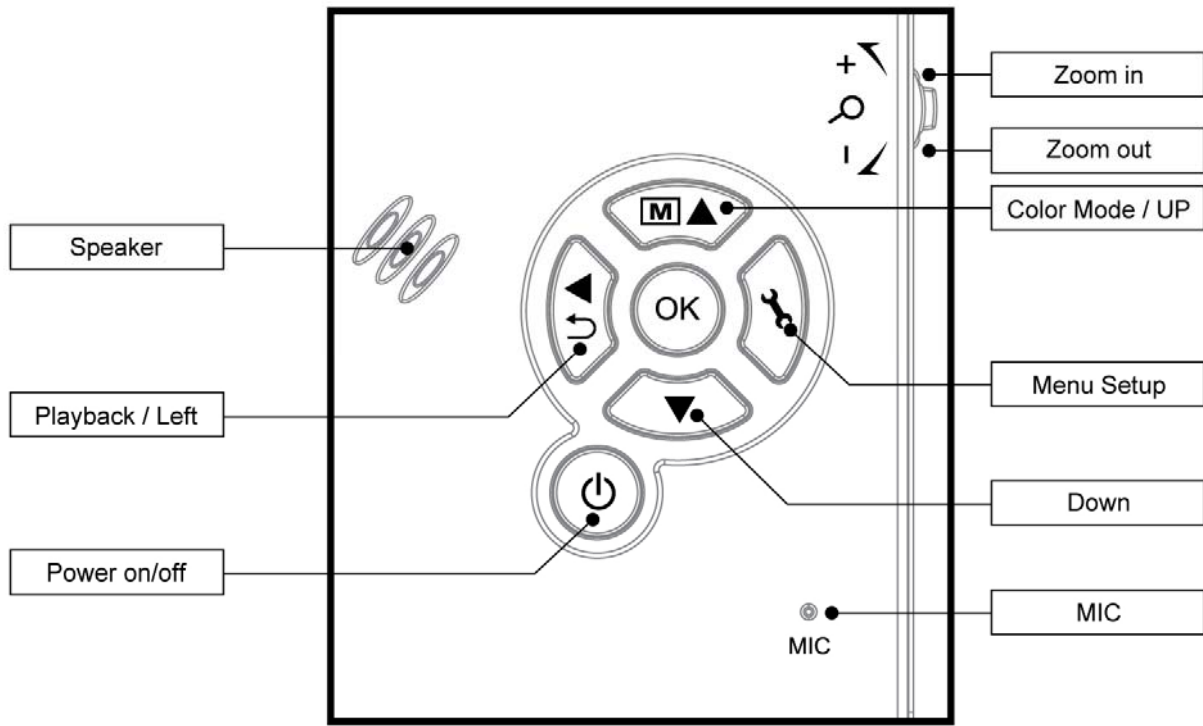

3. Key Features

- 3inches TFT panel
- 5M high quality image sensor (up to 12M by interpolation)
- 20x-200x-500x magnification
- Photo & Video
- Timer
- Measurement (when working on computer)
- Support MicroSD card up to 32GB
- Driver free to download for Windows XP SP2/ Vista/Win7/Win8 and Mac OS 10.6 ~ 10.8 (direct plug-in, driver installation not required)

- Lithium battery (rechargeable & changeable)

4. Use the Microscope

EN

4.1 Install battery

- 1). Open the battery door by sliding it outward.
- 2). Insert the lithium battery to the battery compartment according to the polarities shown in the compartment.

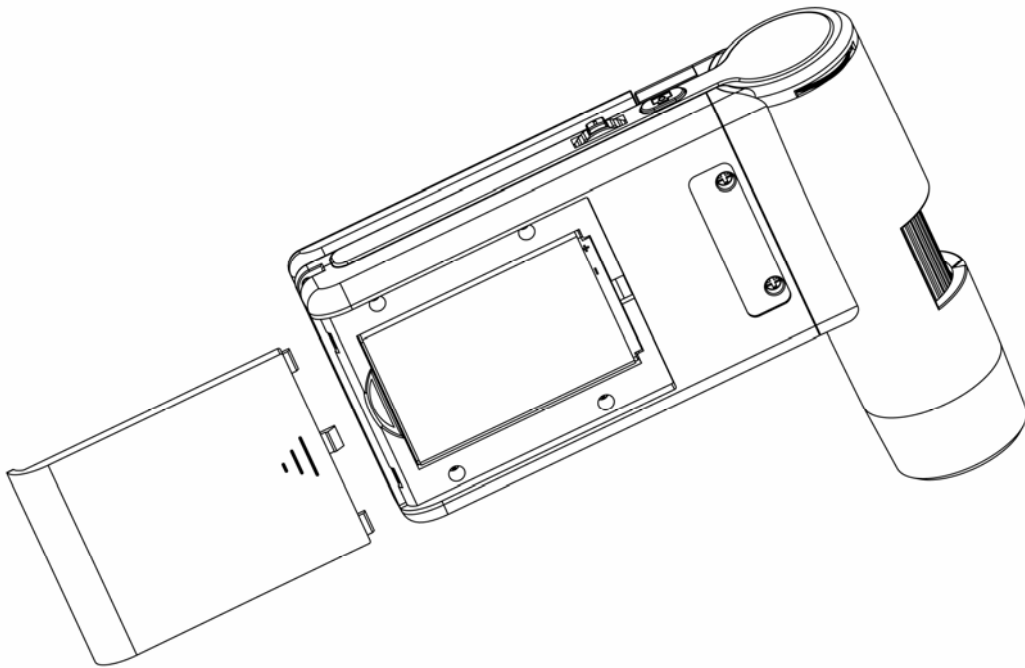

Note: Before using the microscope, you must charge its battery. Please refer to section 4.9 on how to charge the battery.

4.2 Insert a MicroSD Card (not included)

You must insert a MicroSD card (not supplied) to record and store your pictures and videos.

Inserting the MicroSD memory card:

- 1) Turn off the microscope
- 2) Insert the MicroSD card into the MicroSD card slot; gently press in until card is latched.

Note: Do not force the card into the slot; forcing may damage microscope and the MicroSD memory card. Align MicroSD card position (as marked) and try again. The MicroSD memory card must be formatted before capture.



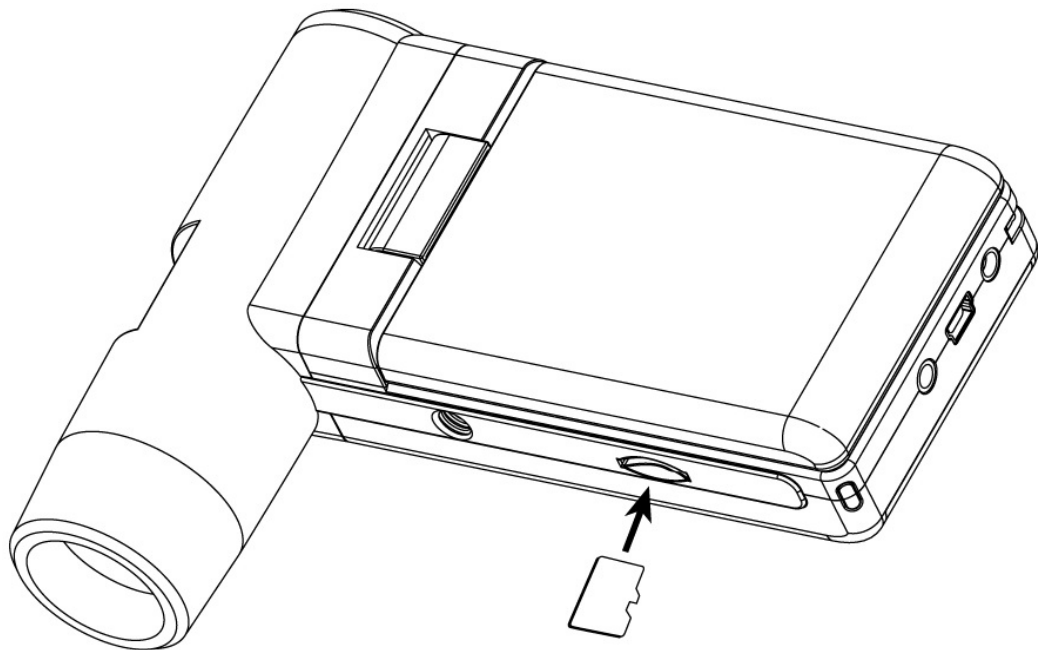

See the following instruction.

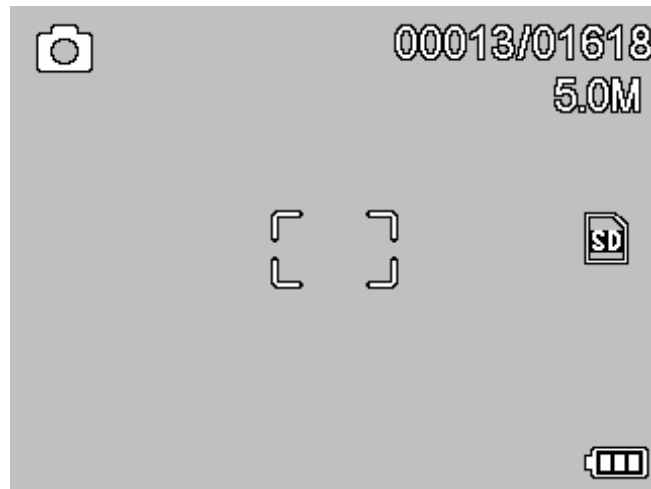

4.3 Display Icons & Meanings

EN

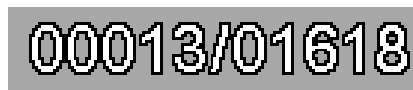
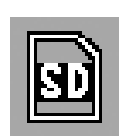

ICON	Meaning
	Still image capture
	Timer capture
	Captured image qty/total qty that could be captured (based on the current resolution)
	MicroSD inserted
	Current resolution
	Battery electricity indicator

Note: The icon displays can be switched on/off by

pressing Zoom Wheel¹⁽²⁾downward vertically.

4.4 Turn on the Microscope

1) Unfold the display panel, and then the microscope will power on directly.

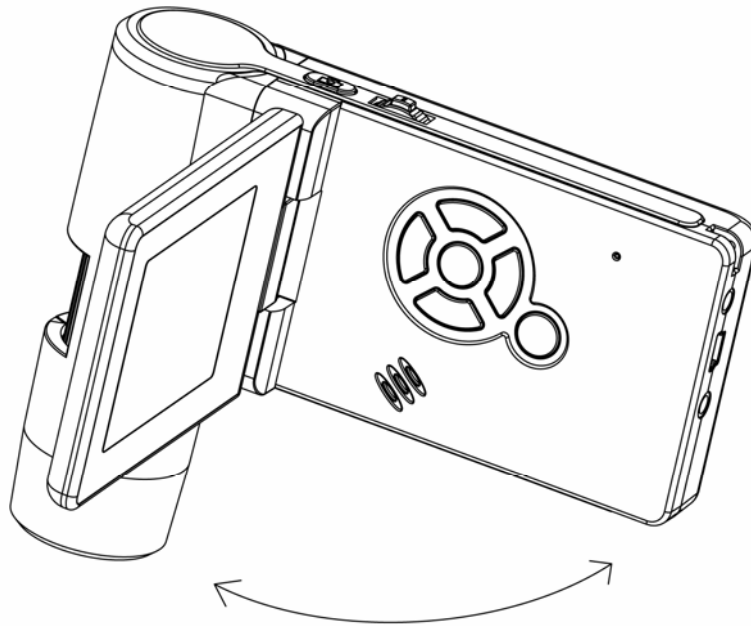

2) If need to power on when panel unfolded, press POWER ON/OFF button.

4.5 Turn off the Microscope

1) Fold the display panel and then the microscope will turn off automatically

2) Press ON/OFF button

3) By Power Save. Please refer to Section 5.2.2 for Power Save setup.

4.6 How to Capture?

- 1) Turn on the microscope by simply unfolding its display panel to a proper position, normally at an angle of 90 degree with the viewing end as follows:

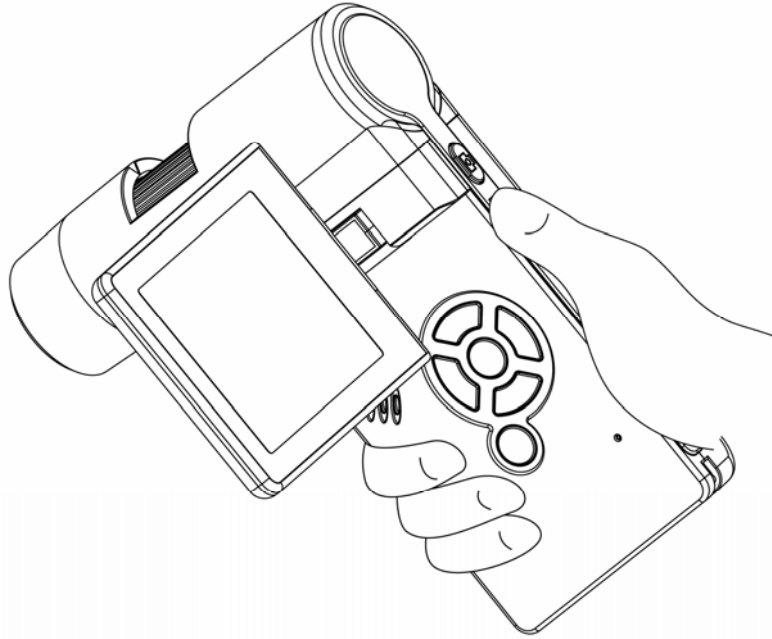

- 2) Adjust the LED brightness dial to get a proper brightness for the LEDs at the viewing end.

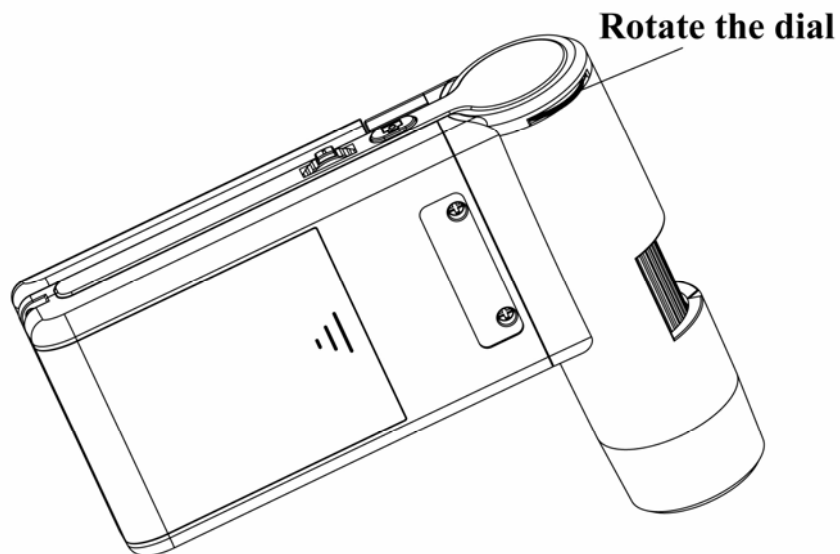

3) Hold the microscope main body by right hand; put the viewing end closely to target object; adjust focus wheel to get clear image by left hand.

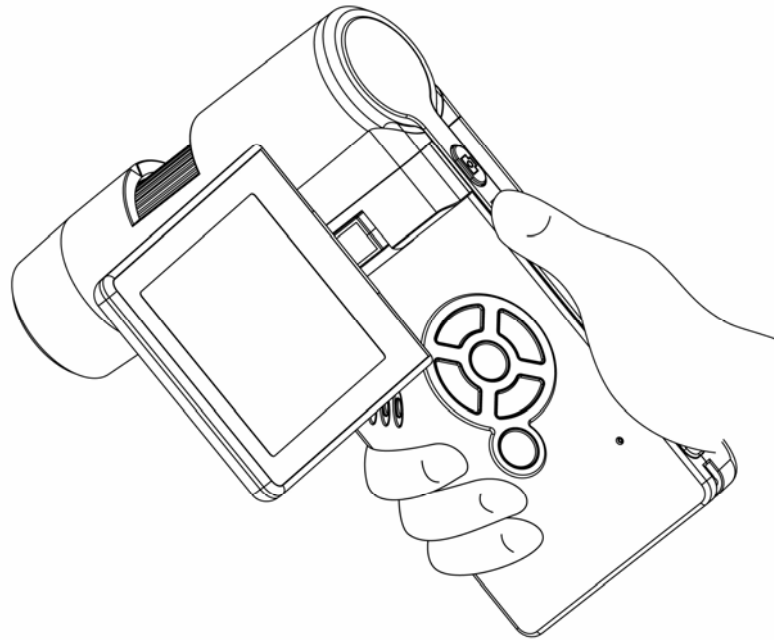

4) When a clear image got, hold the microscope steadily and press Capture button (1) one time.

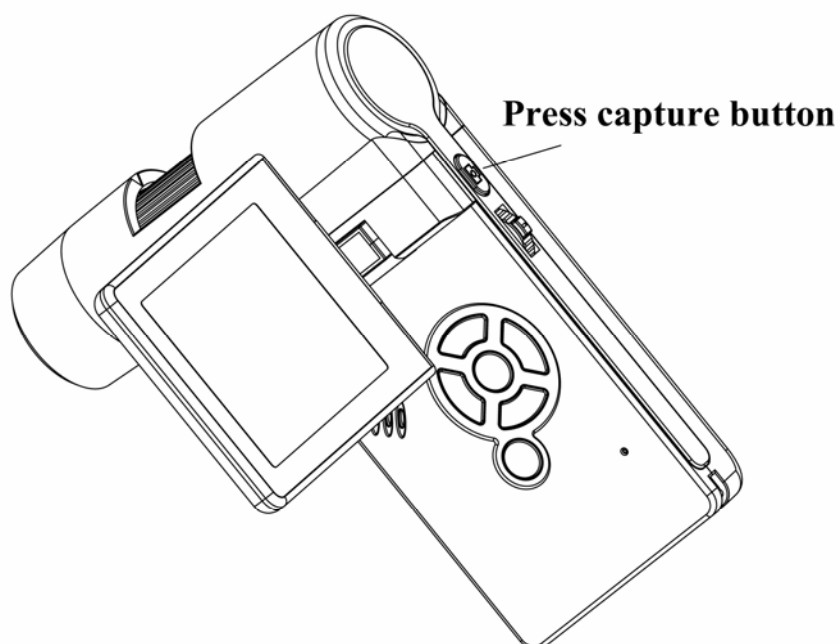

5) Record Video

EN

(1) Press LEFT/BACK (19) to enter video mode as follows. There is video icon on the left corner.

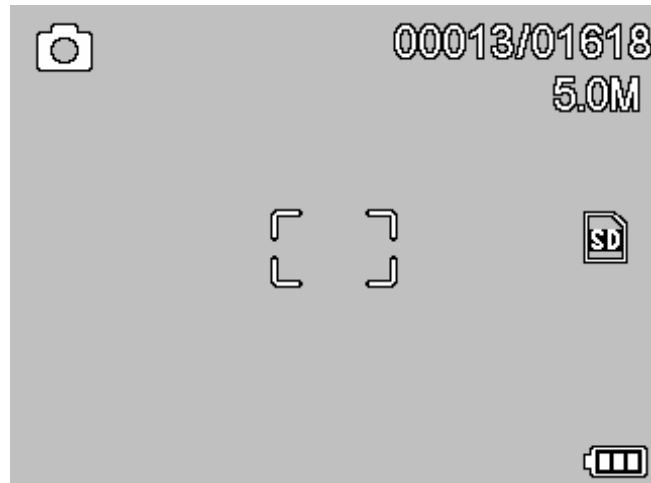

(2) Press Capture button (1) to start recording video. Press again to stop.

6) Play Back

(1) Press LEFT/BACK (19) to enter play back mode as follows. There is review icon on the left corner.



(2) Press UP/DOWN to select among captured

pictures and video clips.

(3) Delete

At play back mode, press  to enter sub-menu as follows, then confirm delete.

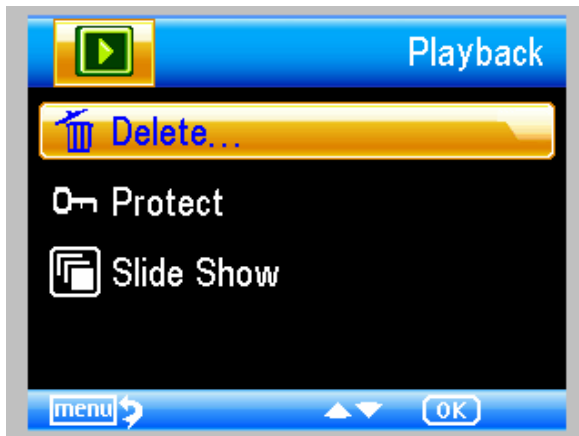

(4) Protect

At play back mode, press  to enter sub-menu as follows, then confirm protect pictures from delete.

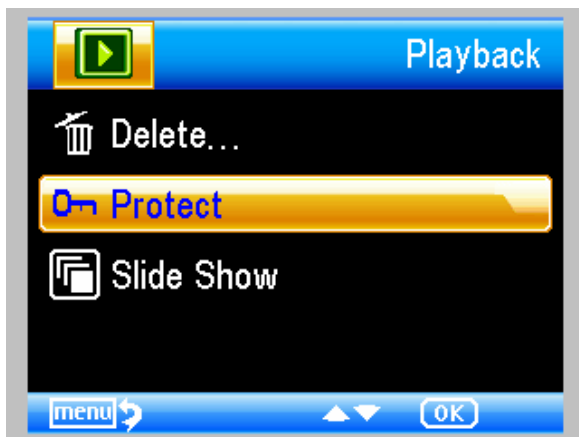

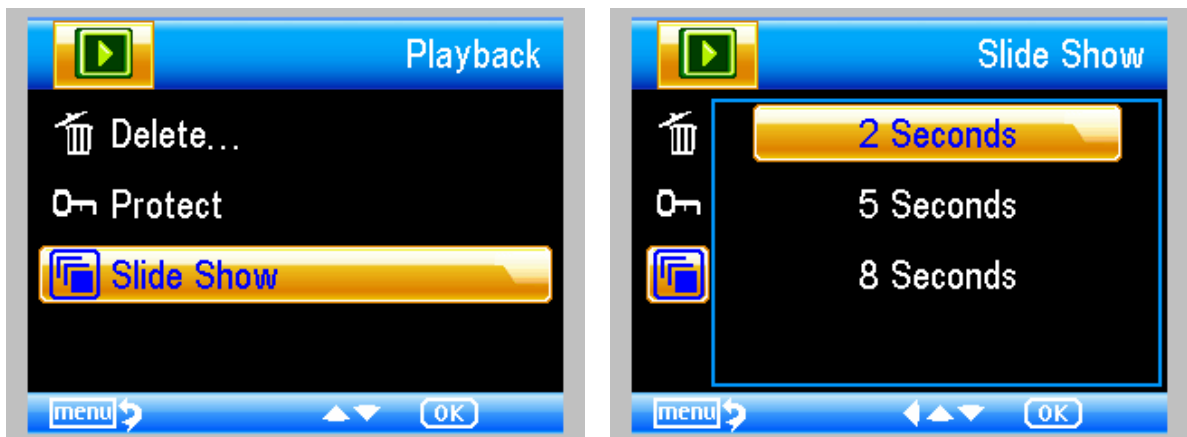

(5) Slide Show

At play back mode, press  to enter sub-menu as follows, select interval time, and then confirm by OK.



7) Color Mode

At preview status, press   to switch among Color/Positive/Negative.

8) **Zoom in:** push Zoom Wheel upwardly

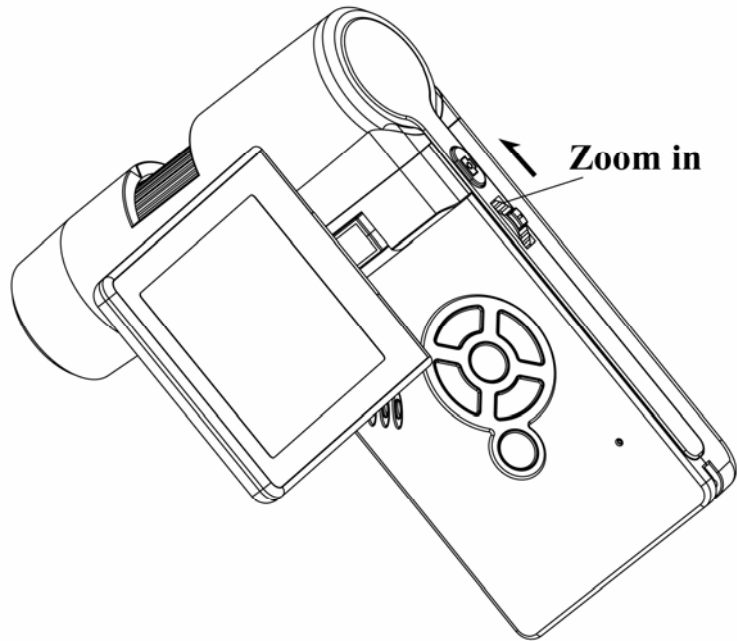

9) **Zoom out:** push Zoom Wheel downwardly

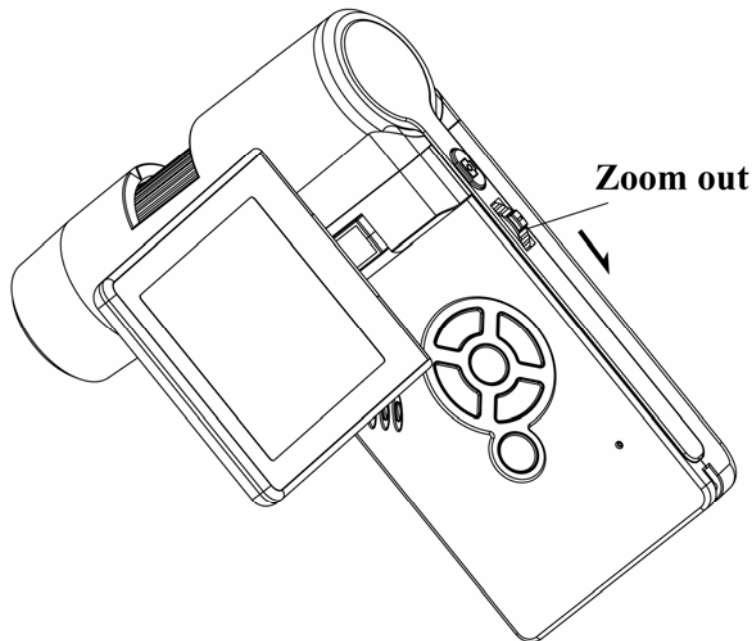

Note: The zoom ranges from 1x – 4x

4.7 Download to Computer

EN

- 1) Connect the microscope to computer by USB cable.
- 2) Choose Mass Storage and then you can view stored photos & videos.

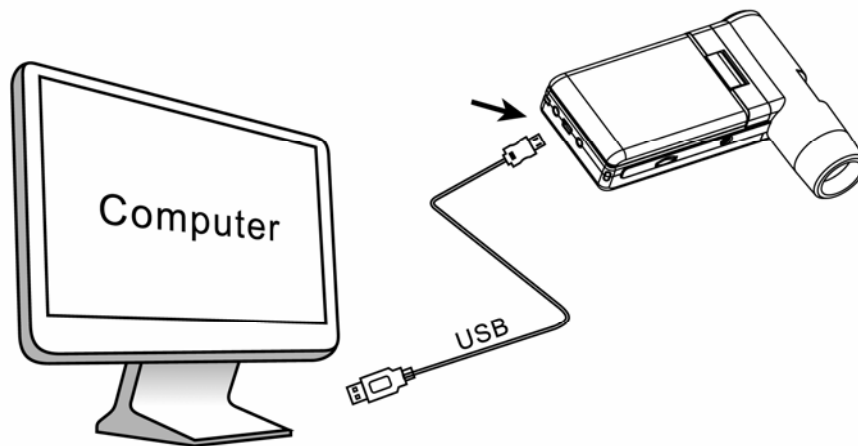

4.8 Preview on Computer

- 1) Connect the microscope to computer by USB cable.
- 2) Choose PC Camera mode
- 3) Start PortableCapture software. Please refer to Part II on how to use the microscope by PortableCapture software.

Note:

- 1) When working on computer, the button functions are no longer valid, but most of functions are available by PortableCapture software.
- 2) Voice recording is not available in PC camera mode
- 3) Images and videos captured from PC camera mode are not stored in micro SD card, they store in the PC.

4) The microscope can be used as a webcam device for microscopic live video.

4.9 Charge Battery

Before using the microscope, you must charge its battery.

1. Plug the small end of the power adaptor into the DC-in port located on the bottom side of the unit. Then plug the other end of the power adaptor into a standard AC outlet. The battery indicator LED at the end corner of the unit will be in red to show that the battery is charging.

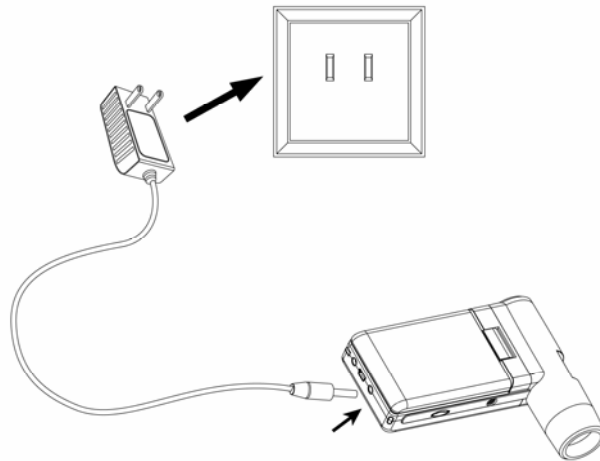

2. When the battery is finished charging, the battery indicator LED will be in off. Unplug the unit.
3. You can now use your microscope for up to four hours of continuous use. When the battery is low, there will be low-power indicator on the right down corner of the panel, front LED light will become weak and image quality becomes poor. Then you have to connect the power adaptor and plug it in to recharge the battery.

4.10 Connect to TV

EN

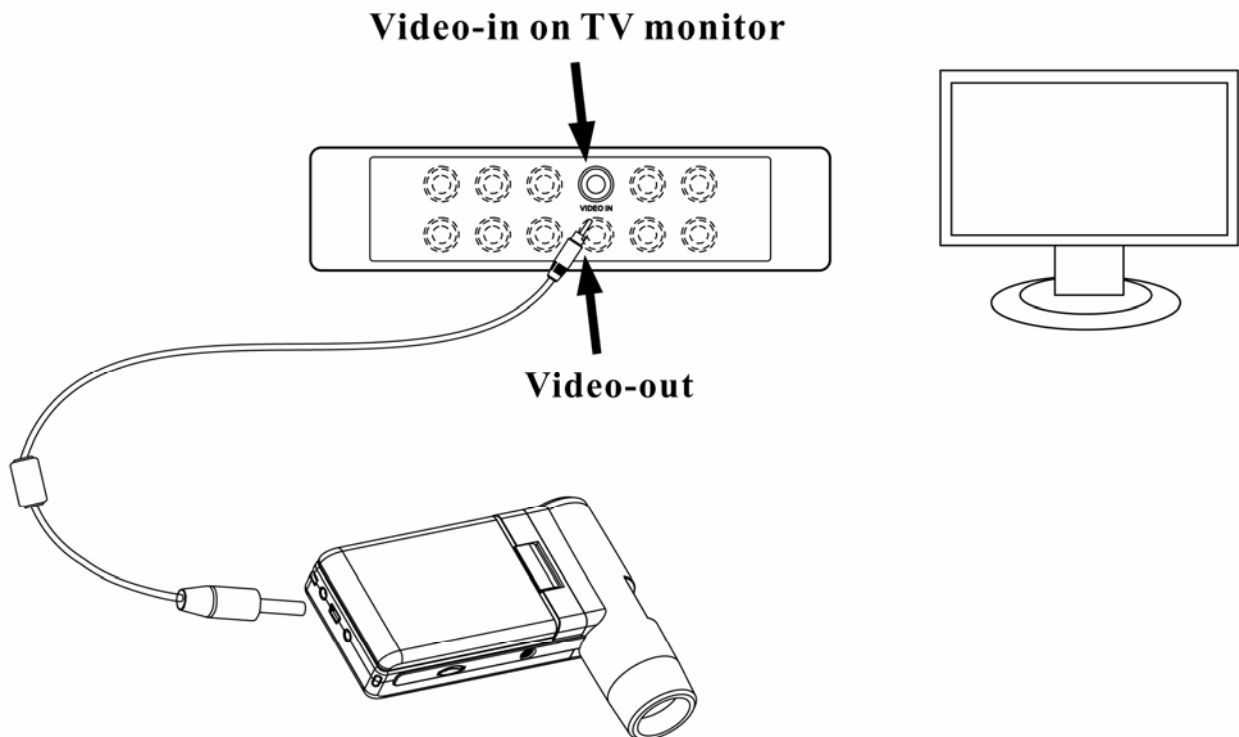

1. Insert the 1/8-inch plug on the end of the supplied video cable into the microscopes Video port.
2. Insert the RCA plug on the video cable into one of your television's yellow video input connectors. Refer to your television's manual for more information on locating these connectors.
3. Turn on the television. If necessary, switch your television to the appropriate input channel. Items that you magnify appear on the television screen.

4.11 Mount Tripod

1) Put the stand end with screw toward the mount hole on the microscope properly and rotate the end into the hold carefully.

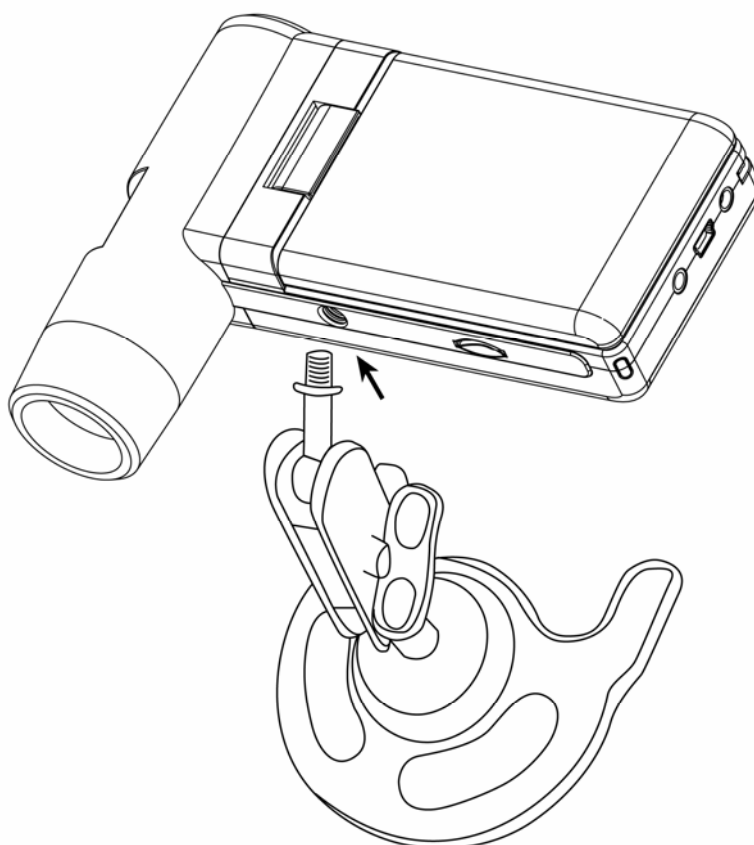

Do not force the end into the hole; forcing may damage the microscope.

2) Adjust the height of the stand at a proper position.

5.1 Main Menu I

Press  to enter main menu I as follows:



Here you can setup Resolution/Timer/Quality/Sharpness.

5.1.1 Set Resolution

1) From the main menu I, choose Resolution and then select a resolution between VGA / 1.3M / 3M / 5M / 9M / 12M.



2) Press OK to confirm selection.

5.1.2 Timer

1) From the main menu I , choose Timer and then enter Timer setup:

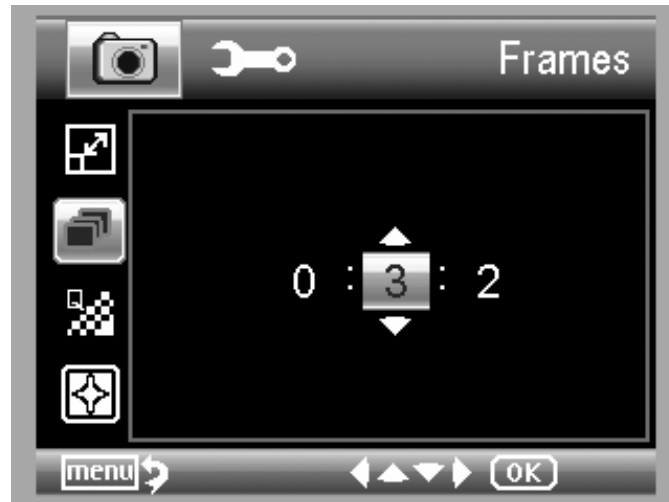

Frames: input quantity of frames you want to take by UP/DOWN and LEFT/RIGHT.

The above setup means 32 frames.



Interval: input interval time between frame capture by UP/DOWN and LEFT/RIGHT.

The above setup means interval time is 15 seconds between each two captures.

- 3) Press OK to confirm selection and press BACK (19) back to preview status. Then press Capture (1) to start auto capture. When at auto capture status, there is



at the left corner of the screen.

- 4) When all frames captured, microscope will return to normal preview.
- 5) If you need to stop auto capture during the capture process, press Capture one time.

5.1.3 Quality

From the main menu I , choose Quality and then select among Super Fine/Fine/Normal.



The three selections will result in different image compress ratio.

5.1.4 Sharpness

From the main menu I , choose Sharpness and then select among Super Fine/Fine/Normal.

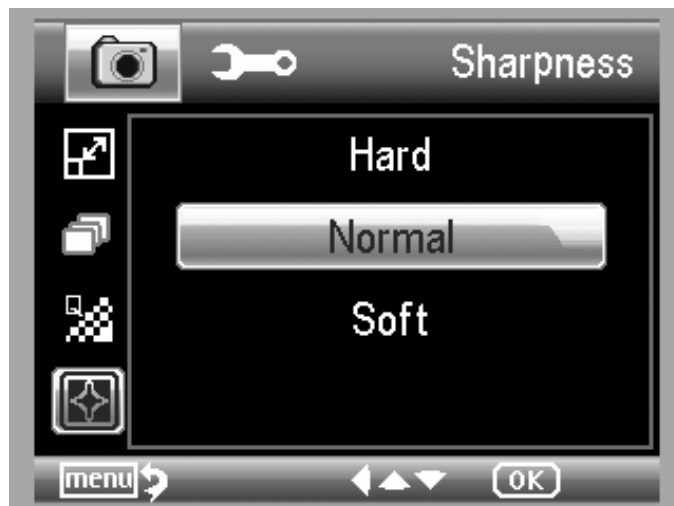

5.2 Main Menu II

Press  to enter main menu I, and then press LEFT to enter Main Menu II as follows:



Here you can setup Language/Power Save/Frequency/ Date Stamp/TV Out/Date and Time/Format SD/ System Reset/Version.

5.2.1 Language

EN

From the main menu II, choose Language and then select a target language by UP/DOWN.



5.2.2 Power Save

1) From the main menu II, choose Power Save and then select among the following a target time for the microscope to power off without key operation.



5.2.3 Frequency

From the main menu II, choose Frequency to enter the following menu:

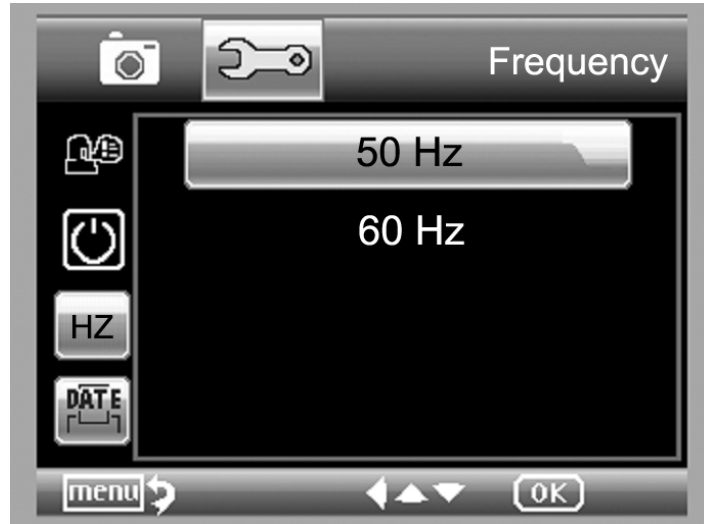

Set up frequency by up/down.

5.2.4 Date Stamp

1) From the main menu II, choose Date Stamp to enter the following menu:



2) Select Date/Time, Date or Off.

Date/Time: both date and time will be marked on images taken.

Date: on date will be marked on images taken

Off: None of date and time info will be marked on

images taken.

5.2.5 TV Out

From the main menu II, choose TV Out and then select, between NTSC and PAL, the correct mode compatible with your TV.



5.2.6 Date/time

From the main menu II, choose Date/Time to setup date and time.



- 1) Setup date and time by LEFT/RIGHT/UP/DOWN
- 2) Setup date mode among YY/MM/DD, DD/MM/YY, and MM/DD/YY.

5.2.7 Format SD

From the main menu II , choose Format SD to format the MicroSD card inserted.

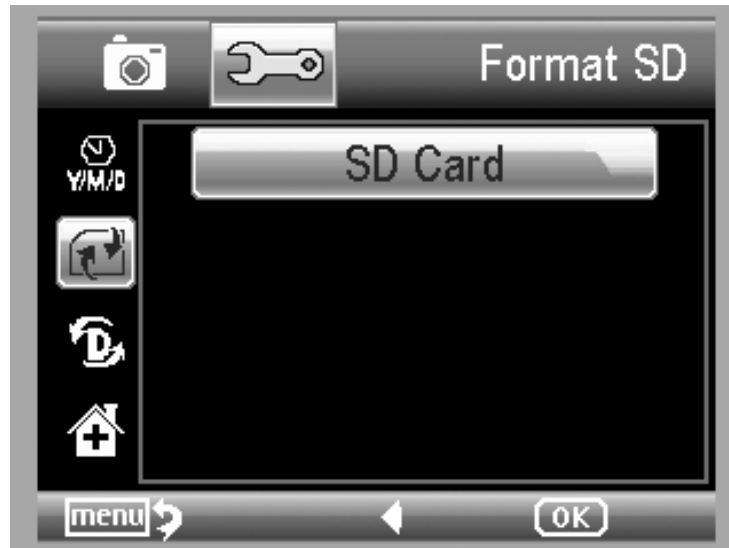

5.2.8 System Reset

From the main menu II , choose Sys. Reset to reset the system back to default.



5.2.9 Version

From the main menu II , choose Version to view the current machine version.

6. Specifications

EN

Image sensor:	5M high quality Image Sensor
Magnifications:	20x-200x-500x
Resolutions:	12M, 8M, 5M, 3M, 1.3M, VGA
Lens:	High quality microscopic lens
Display:	3inches TFT panel, 4:3 ratio
Light sources:	8 LEDs with adjustable brightness
Power sources:	Li-ion 3.7V / 800mAh battery Working time: 4 hours; Charging time: 5 hours
Frame rate:	30fps
Adaptor:	Input:100-240V, 50/60Hz; Output: 5V, 1A
OSD languages:	English/Germany/French/Spanish/Italian/ Portugese/Japanese/Chinese
Software languages:	English/Germany/French/Spanish
Measurement:	By software
Size:	130x103x29mm
Weight:	(with battery)

7. Computer System Minimum Requirement

Operating system	Windows XP SP2/Vista/Win7/Win8, Mac 10.6 ~ 10.8
CPU	Pentium 11 or above
RAM	256MB
Interface	USB port2.0

8. Troubleshooting

EN

Problems	Solution
The unit does not turn on.	Charge the battery.
The screen is blank.	Ensure that the power is on. Charge the battery. Verify that the item you want to magnify is Positioned correctly under the lens.
There are smudges or blemishes on the screen	Clean the screen and lens carefully with soft fabric
Microscope is connected to a television, but no image appears on the television screen.	Ensure that the television is on. Switch to the appropriate video input channel on your television. Ensure that the video cable is securely connected to the Microscope Video-out port and plugged into the correct video input on your television.
The battery indicator LED is not in red, even though the power adaptor is connected and plugged into a wall socket. -or- The battery is not charging.	Plugged into the Microscope's DC-in port. Ensure that the outlet has power and is not malfunctioning. If the outlet is connected to a wall switch, make sure that the switch is on.

PortableCapture Software Introduction

■ Computer System Requirements

- Windows XP/VISTA/WIN7/WIN8 & Mac10.6 ~ 10.8
- P4 1.8 or above
- RAM: 256M
- Video Memory: 32M
- USB port: 2.0
- CD-ROM Drive

1. Install Software

1) Insert the driver CD into CD-ROM Drive and this will automatically display the following interface:



2) Click **PortableCapture software** and then reboot the system when asked.

3) You can browse the User's manual in PDF format and the CD contents by choosing the corresponding menus.

2. Start Microscope

Connect your Microscope to your PC USB port, start the

software by clicking the  icon generated on the desktop after installation and you will see the following screen pop up.

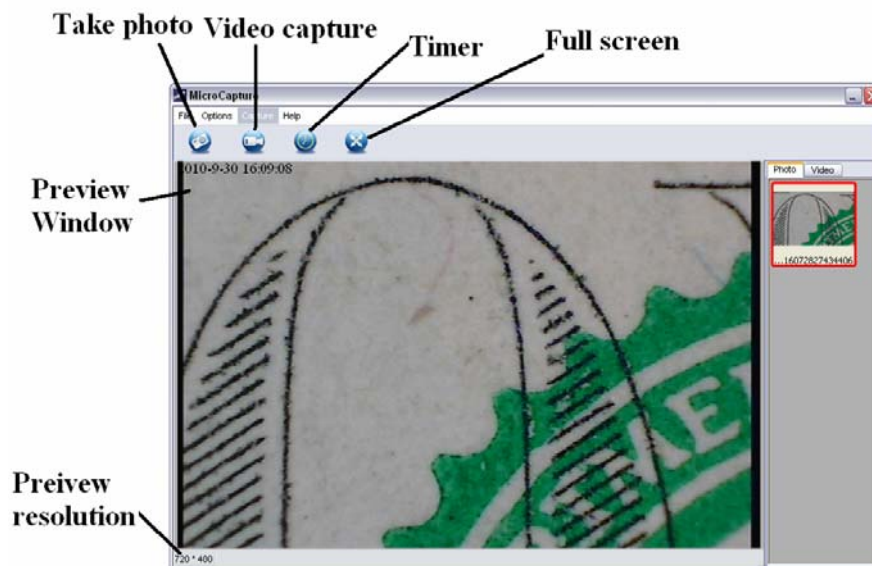

When the Microscope is disconnected from your PC USB port, the screen will display “***No Device detected, please connect your Microscope directly to your PC USB port.***”

No Device detected, please connect your Microscope directly to your PC USB port.

3. Software Introductions

EN

1) Preview Size

You can change the preview size by the following operation:

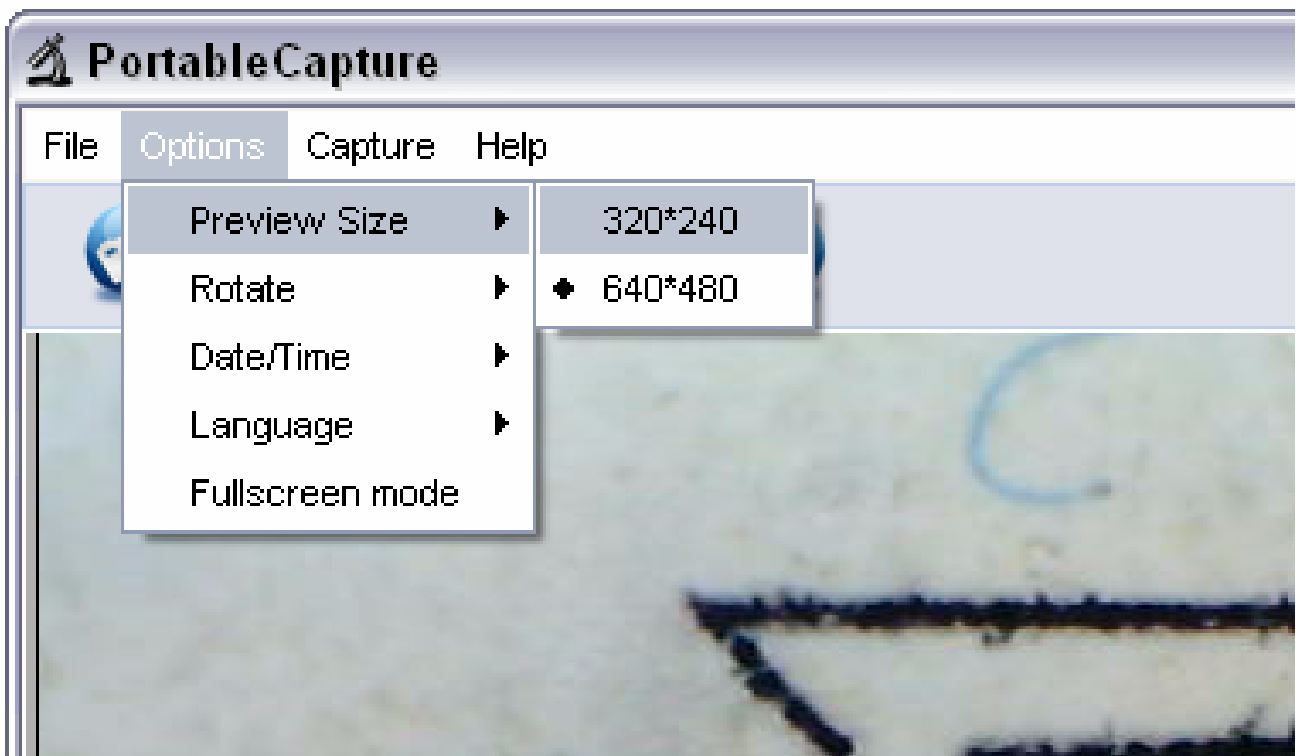

Note: The size of the photo taken is equivalent to the preview size selected in the Options menu/Preview Size.

2) Rotate Image

You can rotate the output image clockwise and counter-clockwise.

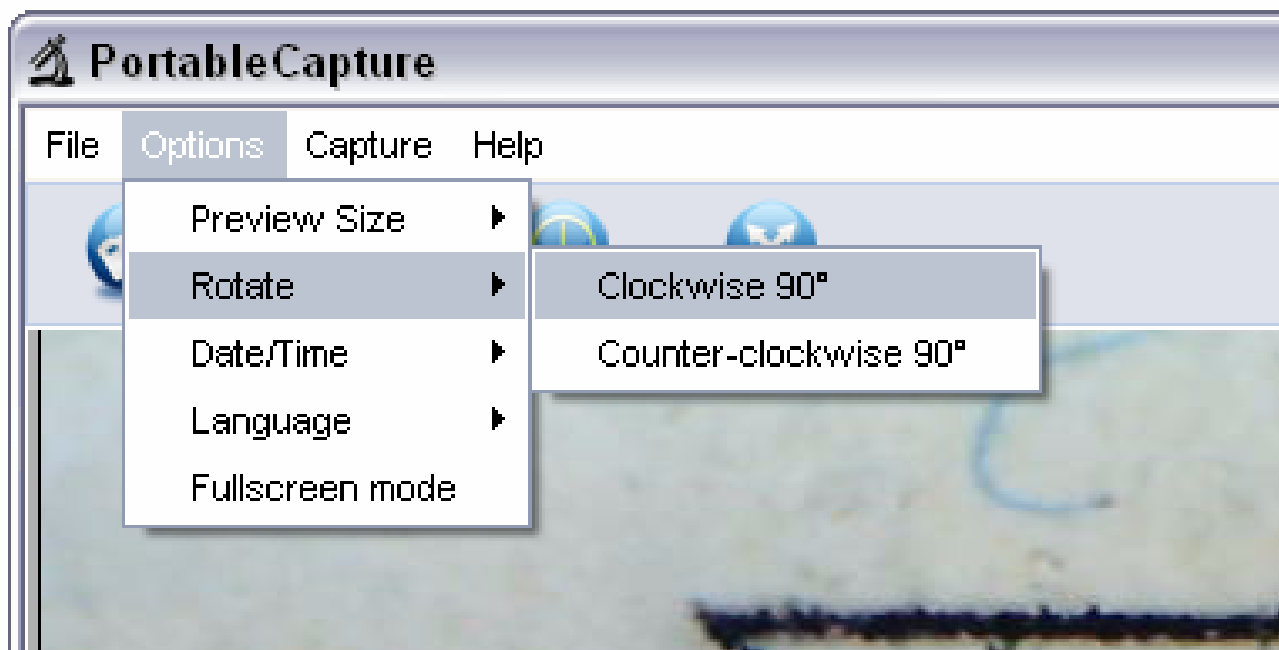

3) Date/Time

You can display or turn off Date/Time by the following operation:

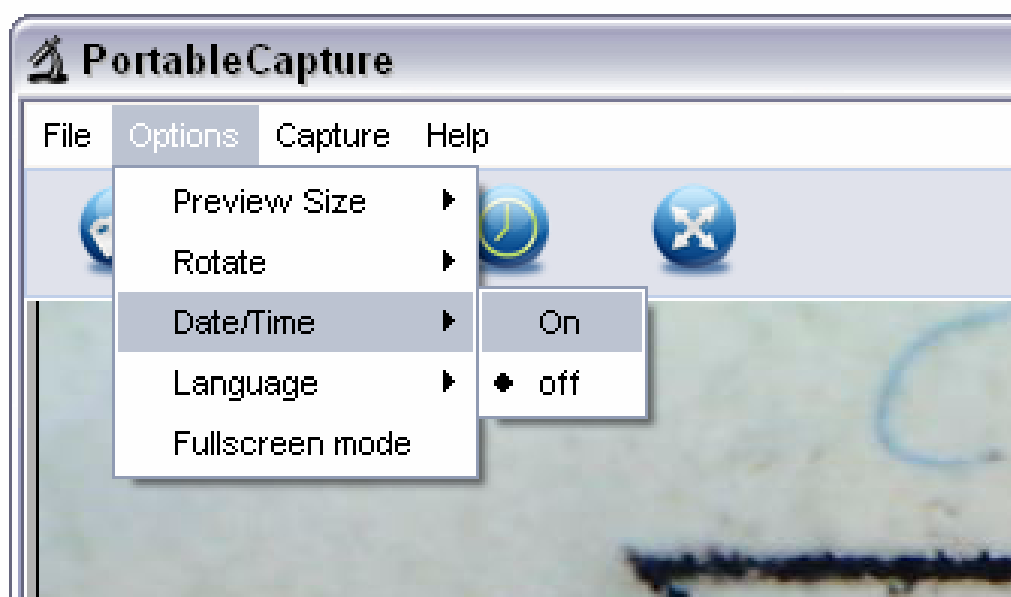

4) Language

You can choose On Screen Display language by the following operation:

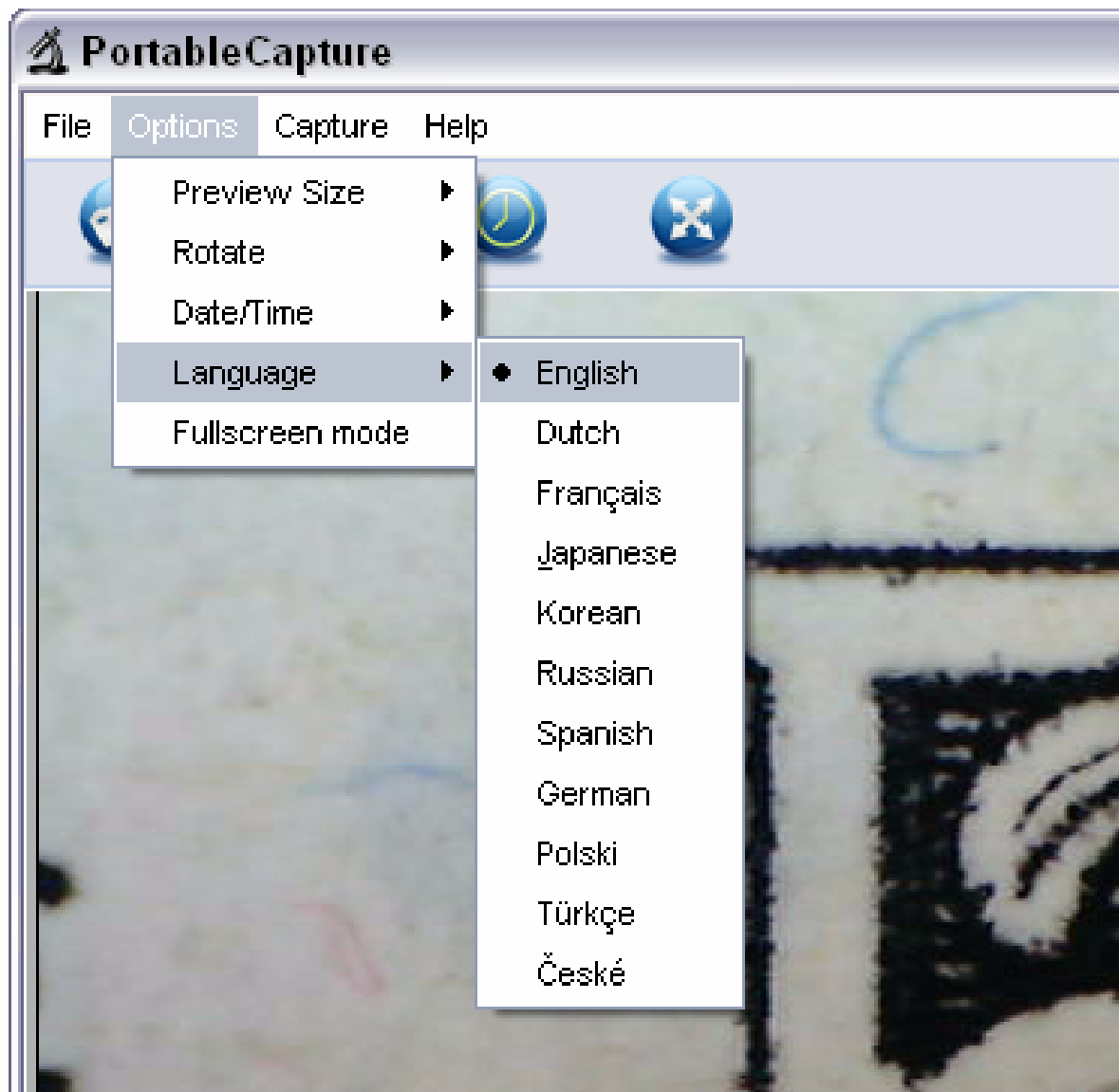

5) Full screen

You can enter & quit full screen mode by:

- (1) Double-clicking the preview area.
- (2) Clicking the full screen icon:



- (3) Choose **Full screen mode** from menu.

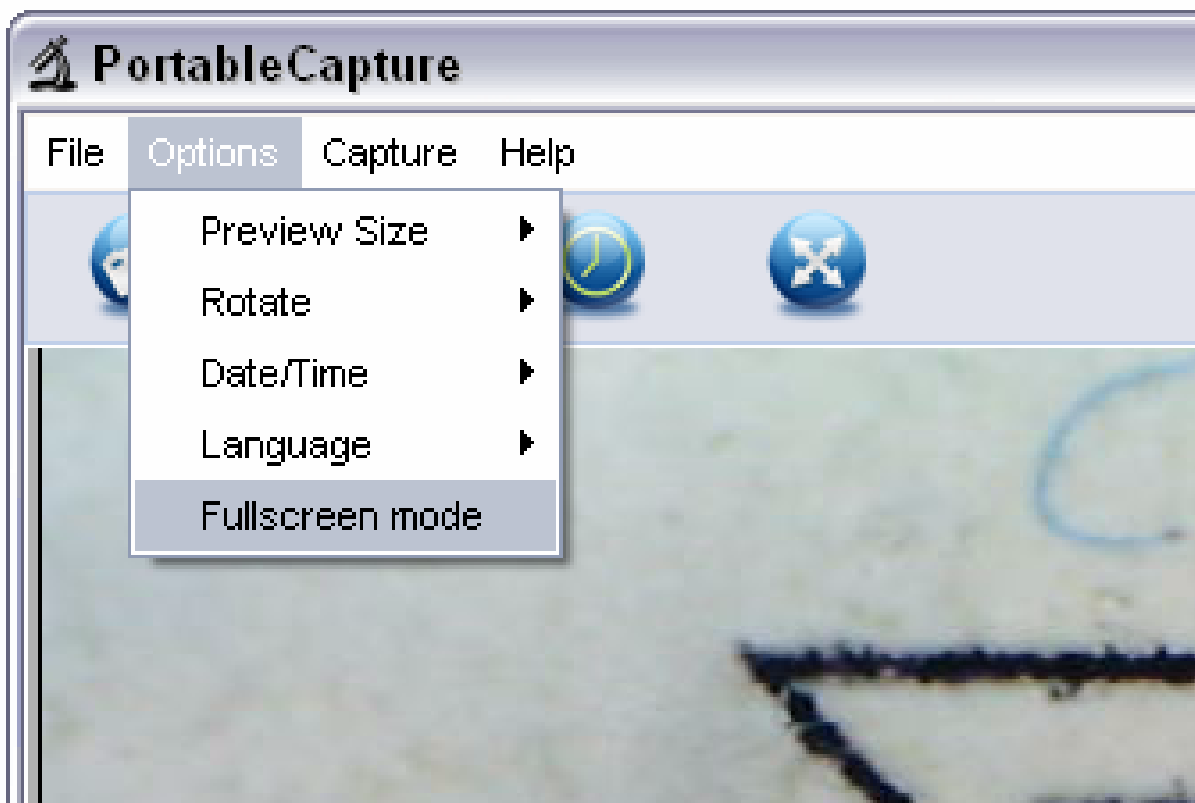

When in full screen mode, click on the Full screen icon to turn off and restore toolbars and menus.

6) Capture

(1) Photo capture

You can take photos by either of the following ways:

- Click the camera button 
- Choose **Capture** and then click **Photo**
- By pressing F11

Captured photos are saved automatically and image thumbnails will be available on the right side of the PortableCapture screen for further editing. For editing photo, please refer to later operations.

(2) Video capture

You can record video by either of the following two ways:

- Click the video camera button 
- Choose from the menu bar **Capture** and then click **Video**

When recording, there is a red dot flashing on the video camera button.



Video is saved in AVI format.

Stop capture:

- Click the flashing video camera button
- Choose **Capture** and then click **Stop capturing**

Note: Please note the best pixels for video capturing is 640x480.

7) Edit Photos

(1). Preview photos

- Clicking on an image thumbnail will display the image selected on the preview area, with its size displayed on the left-bottom corner.
- You can double click the image thumbnail and an independent preview box will pop up as shown below:

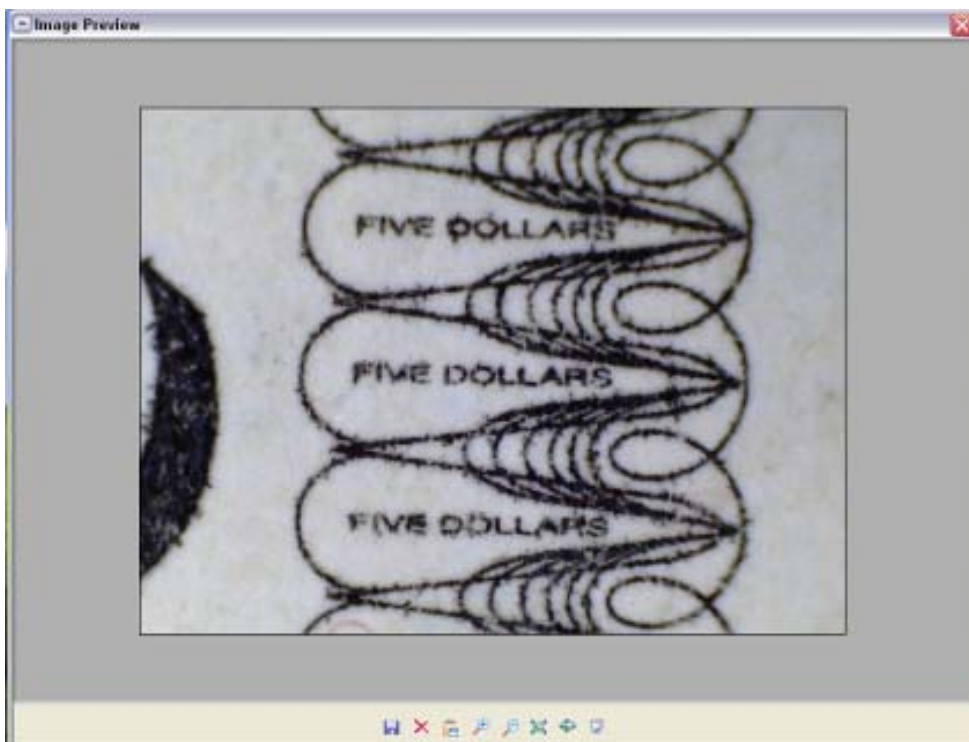

(2). Save Photos



You can save photo by right clicking on the thumbnail and then choose **Save**.

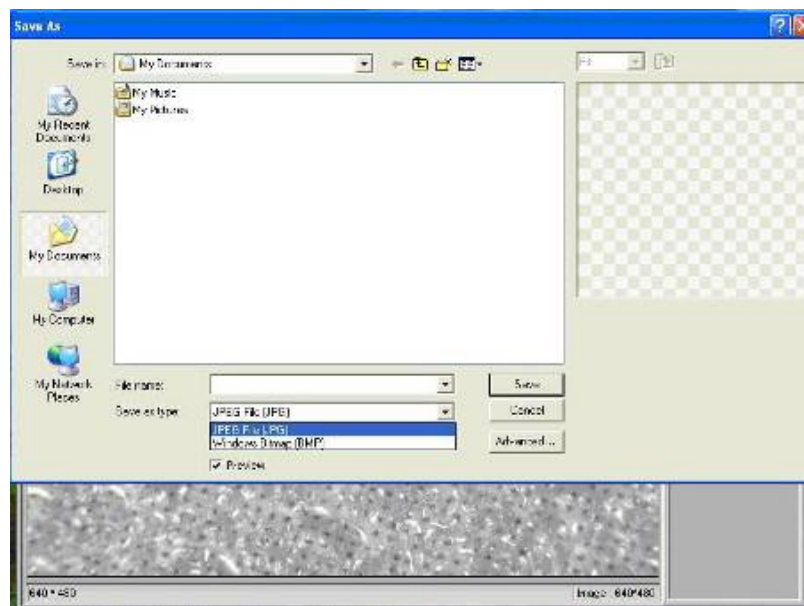

The file can be saved in either jpeg or bmp. The jpeg size in which the photo is saved is the maximum allowed for jpeg. You can choose to decrease the size by adjusting quality. Click the Advanced button to view and select jpeg save options.

(3). Delete photos

By right clicking and then choosing **Delete**, you can delete the selected photo

Or, at the independent preview box you can choose delete icon to delete the previewed photo.

(4). Copy photos

Right click on the thumbnail and then choose **Copy**.

8) Edit videos

You can right click the video small icon listed on the right column and then choose **Play**, **Copy**, and **Delete** etc.



Directly to save video clips can be set as follows:



9) Quit PortableCapture

EN

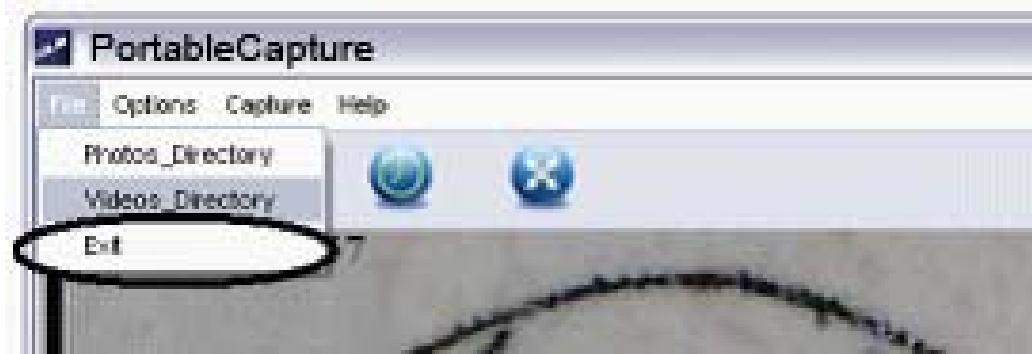

Measurement

- 1 Point the microscope onto a target object e.g. a ruler; rotate the focus wheel to get a clear focus.
- 2 When the focus at the clearest point, take a snapshot
- 3 Watch the calibration at the lower-end of the focus wheel; note down the magnification value that corresponds to the indicator marker on the microscope body as shown below. That value is the magnification at which the focus was set and the image taken. (This is very important, since only with the magnification ratio noted down can the object size be worked out at later steps!!)

**Indicator
marker**



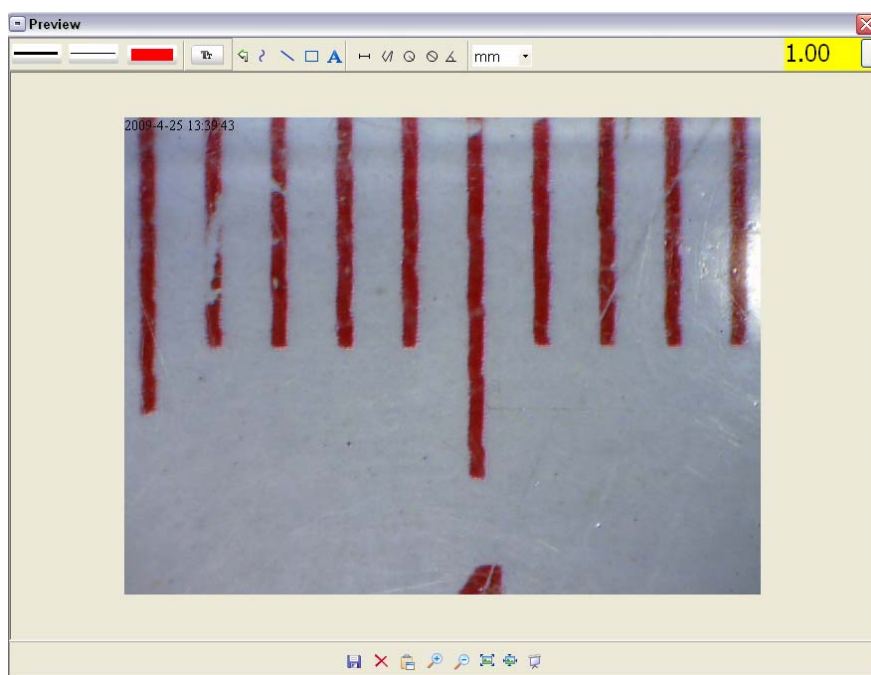

- 4 Open the captured photo double clicking on the thumbnail. A preview window will open



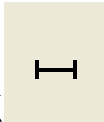

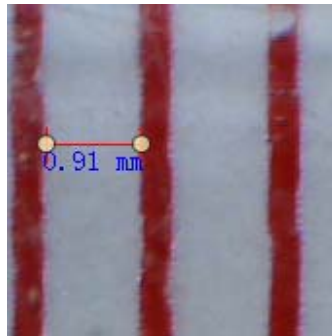
- 5 Input the magnification ratio noted down into the box indicated at the top right corner of the preview window. (Please note it is necessary to input the magnification ratio noted down on step3; otherwise the measurement is meaningless.)
- 6 Now you can measure the size of the whole or part of the object you have taken using the available options. Click on the icons on top of the window. Following are the options:

- 1) Direct line: click , left-click mouse to choose a start point and drag mouse to an end point, Notice that the measurement is displayed. Release the mouse when done.

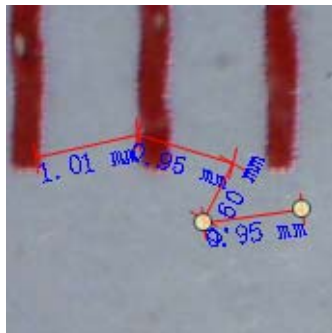

- 2) Multi-line: click , left-click mouse to choose a start point and drag to an end point. Notice that the measurements are displayed as you go along. Release mouse when done. You can continue measuring from the previous end point to a next point and so on.



3) Circle-radius: click , left-click to choose a start point for a circle; draw the circle to an end point, release the mouse, and the radius of the circle will be displayed.

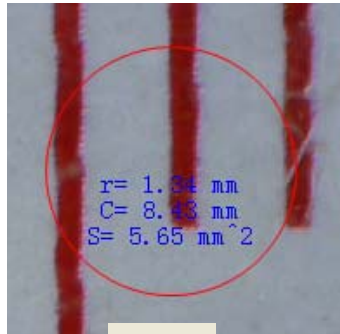

4) Circle-diameter: click , left-clicking to choose a start point for a circle; draw the circle to an end point, release the mouse, and the radius of the circle will be displayed.

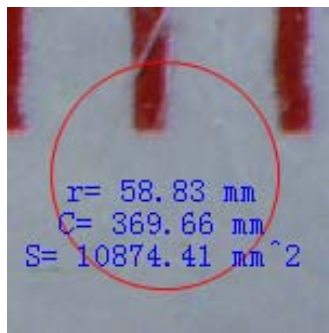



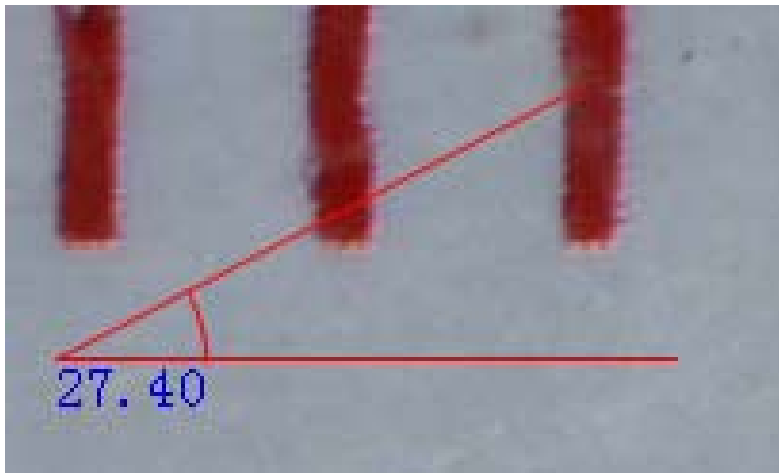



- 5) Angle: click , left-click to choose a start point for an angle, draw the line to another point and then release the mouse to create one line for an angle. Move your mouse to bring out another line of the angle, left-click when the angle is ok. The angle value will then display.



- 6) Unit: click , you can choose the unit at which the measured values display. Units available include: pixels / inches / km / mt / mm / cm / micro

7 Other operations you can carry out on the photo

taken include:

- 1)  : make notes on the photo taken
- 2)  : select font, font style, font size etc
- 3)  : draw line, box etc on the photo
- 4)  : line color
- 5)  : line thickness
- 6)  : line type
- 7)  : undo operation

Note:

1. The magnification ratio you are allowed to input is from 20 to 200. Do not input any value beyond that.
2. The measurement value worked out by the software is only for reference; it may not be 100% correct.
3. The measurement function is only available on Windows Operating System.

PortableCapture for Mac

Part I Install PortableCapture

Open *mac* folder from the disc and copy *PortableCapture* onto your desktop for daily use.



Part II Use PortableCapture

EN

1. Plug Microscope into PC USB port.
2. Double click PortableCapture icon to open the PortableCapture window. The microscope is now ready to use.



3. Preview

At the central window, you can preview the magnified subject.



4. Preview Size

From **Options**, you can choose the preview resolution. The current resolution will be displayed at the left bottom corner of the preview window.

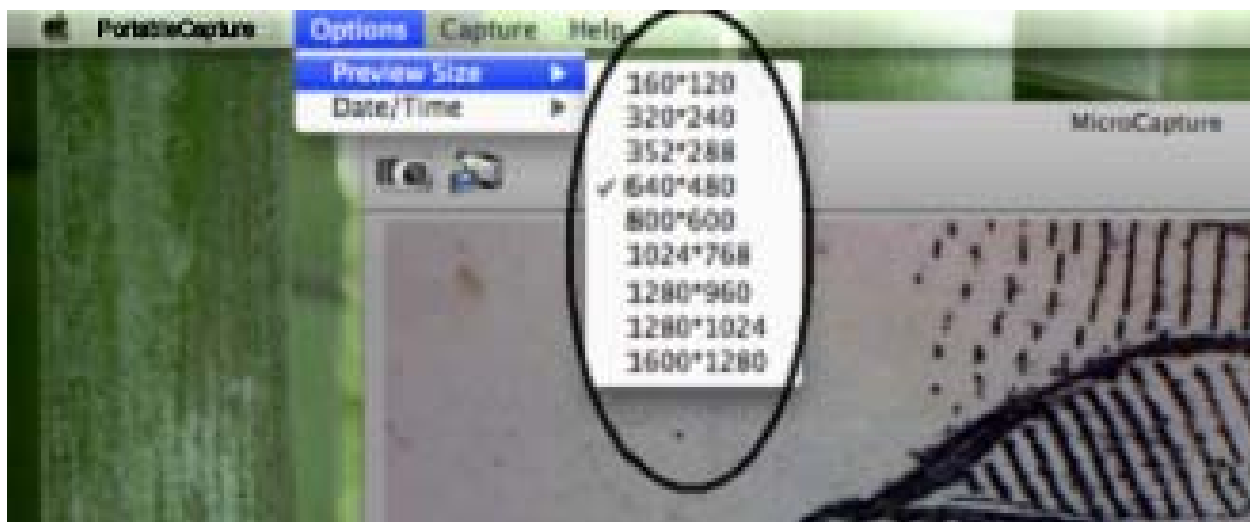

Please note that the preview window size always remains at 640x480 but the current resolution will show at the left bottom corner.

5. Date/Time

From **Options**, you can turn the date/time on or off.

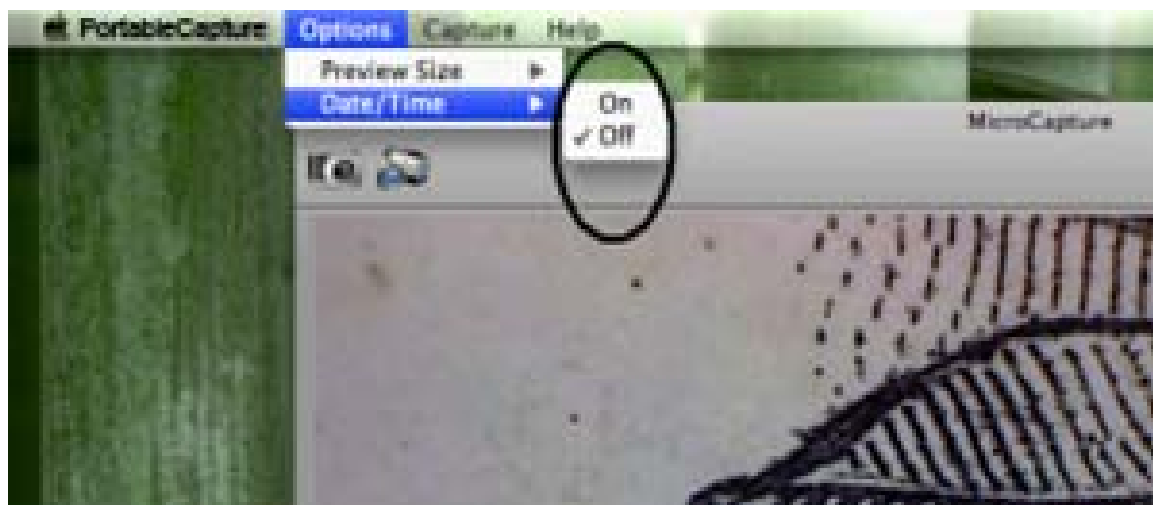

6. Photo Capture

You can capture photo by:

- Choosing **Capture/Photo**

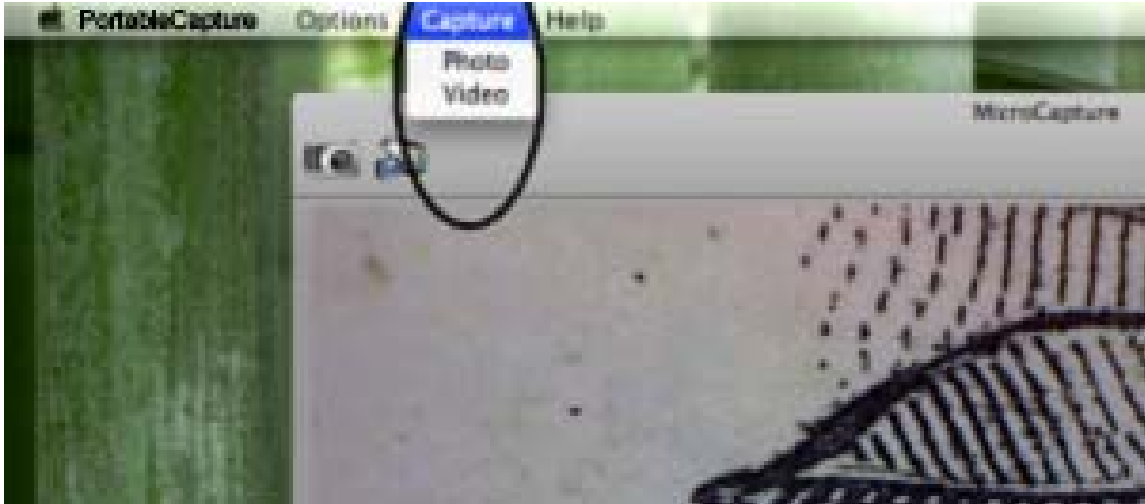

- clicking photo capture icon



The captured photos will appear as thumbnails on the right side of the preview window.

7. Video Capture

You can capture video by:

- 1) choosing **Capture/Video**

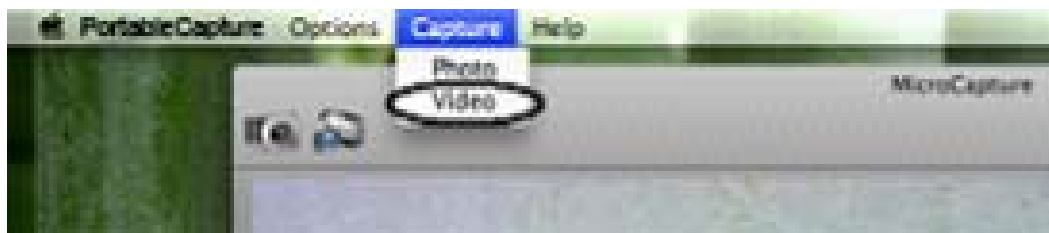

- 2) clicking video capture icon

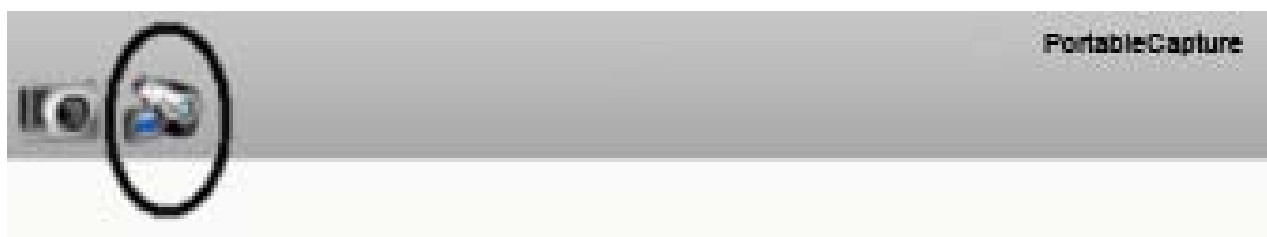

Note: After clicking on the icon, the video capture icon will turn red to indicate video clip recording. Click the red icon again, to stop recording!!

The captured videos will be appear as thumbnails on the right side of the preview window under Video tab.

8. Edit Photo/Video

Captured photo & video appear as thumbnails on the right side of the preview window.



1) photo

Double click a photo thumbnail to open in the main preview window

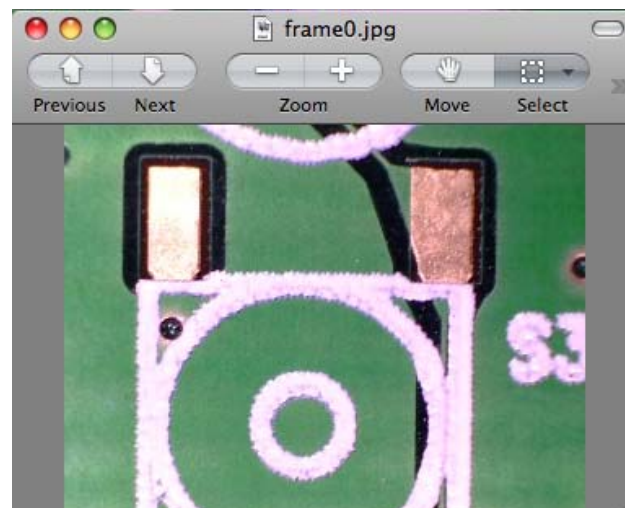

You can then carry out operations as you normally do on Mac system.

2) Video

Click a video clip thumbnail, the video will play automatically.

9. Help info

By choosing **About PortableCapture**, you can get help info from your local agent.

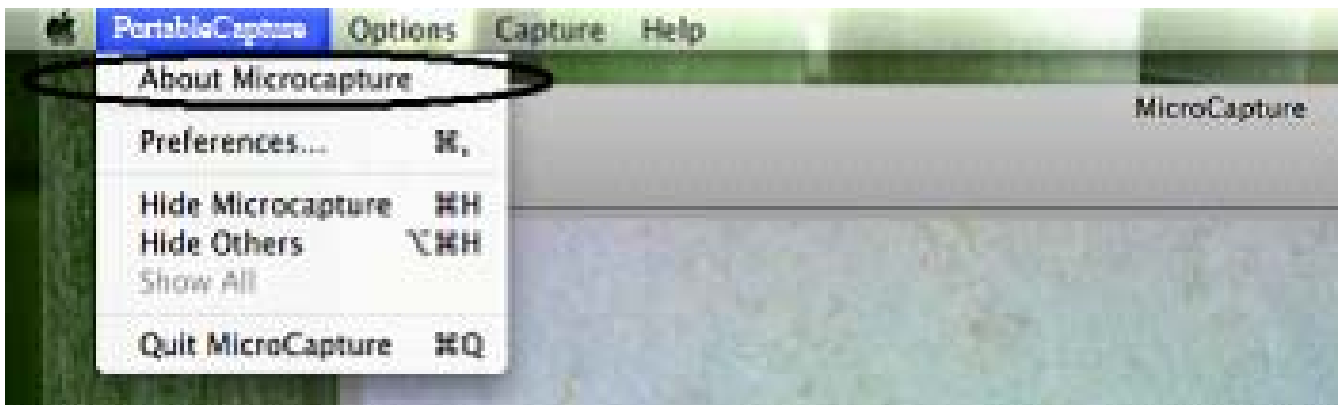

10. Quit PortableCapture

Choose **Quit PortableCapture** as follows, you can quit the software.

This symbol on the product or in the instructions means that your electrical and electronic equipment should be disposed at the end of its life separately from your household waste. There are separate collection systems for recycling in the EU. For more information, please contact the local authority or your retailer where you purchased the product.

