

Measuring transducer for frequency, input NORIS standard signal

- Straightforward application
- Suitable for severe operating conditions
- Compact construction
- Galvanic isolation between sensor input and operating voltage to the output signal
- Frequency ranges to suit customer requirements
- Provision made for fine adjustment of measuring range
- Anti-tamper seal for the fine adjustment
- Meet high EMC-requirements
- Meet high EMC-requirements
- Short-circuit-proof output selectable from 0 ... 10 V/DC, 2 ... 10 V/DC, 0 ... 20 mA, 4 ... 20 mA
- Operating characteristics displayed by integrated LED
- Flame-inhibiting and self-extinguishing body
- Suitable speed sensors are available (NORIS devices FA../ FT..)

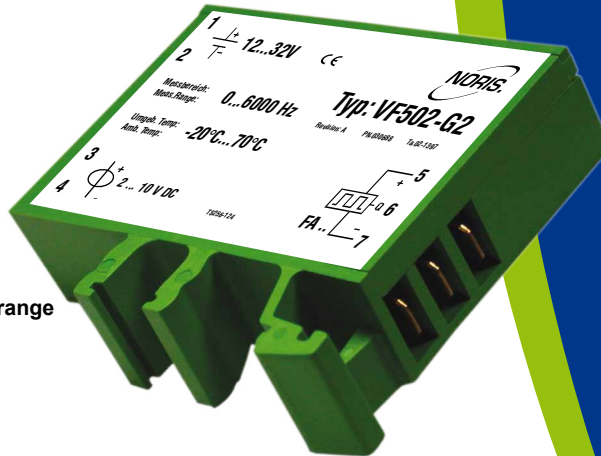

Image
VF502-G2



Germanischer Lloyd

Measuring transducers of series 5

Measuring transducers of the Series 5 are designed to convert electric input values into standardised output signals.

Principle of operation: The transducer signal measured at the converter input is converted into a standardised output signal that is proportional to the input and lends itself to further customised processing, for instance, in a machine controller.

General notes on Type VF5..

Description VF5..

- Signal input for a NORIS standard frequency signal
- Suitable to evaluate sensors of the FT.. and FA.. series
- Input range: 0 ... 10.000 Hz (according to type)
- Maximum range frequency between: 50 ... 100 Hz (VF500..), 100 ... 1.000 Hz (VF501..), 1.000 ... 10.000 Hz (VF502..) (Factory-set frequency adjustment)

To avoid triggering errors the frequency full range set in factory must be the highest frequency of the measuring chaîne.

Electric isolation

The operating voltage and sensor input are electrically isolated from the output signal. Therefore, multiple operation of amplifiers and evaluation devices is possible at the same operating voltage and from only one sensor.

Output signal

The output signal generated is a standardized voltage of 0 ... 10 V/DC or 2 ... 10 V/DC or, respectively, a standardized current of 0 ... 20 mA or 4 ... 20 mA. The output signal follows the input signal strictly linearly (deviation < 0.1%).

The output signal can be used to supply additional devices, such as indicating instruments and limit-value switches. Attention should be paid to the maximum driver capability of the output.

Input signal

The NORIS standard signal corresponds to a rectangular voltage with an amplitude that corresponds to the operating voltage applied. This results in a signal that is immune to interference and tolerates considerable changes in the operating voltage. The operating voltage required by the sensor is provided by the measuring transducer.

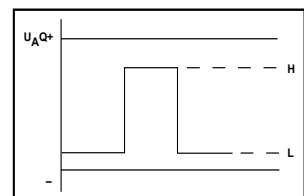

Operating status display by LED

The green LED will be lit when the operating voltage is applied and the device is working normally.

Technical Data

Series VF5..	
Operating voltage	$U_o=9 \dots 32$ V/DC, $U_R=24$ V/DC
Ripple	$< 20\%$ U_o
Reverse voltage protection	Integrated
Overvoltage	2.5 times U_R up to 2 ms
Voltage drops	100% up to 10 ms
Power consumption	Approx. 50 mA (24 V/DC)
Galvanic isolation	Between input signal and operating voltage to the output signal
Input signal	NORIS standard signal from speed sensors FT.. / FA..
Input overloading	$< U_R$
Input resistance	Approx. 5,6 k Ω
Input current	< 5 mA
Output VF5..-G.	0 ... 10 V/DC (VF5..-G1), 2 ... 10 V/DC (VF5..-G2), short-circuit-proof, load current 20 mA max.
Output VF5..-I.	0 ... 20 mA (VF5..-I1), 4 ... 20 mA (VF5..-I2), load resistance 500 Ω max.
Noise voltage	Approx. 20 mV
Error class	IEC51-1 1.5%
Temperature sensitivity	$< \pm 0.1\%$ per 10 °K
Voltage sensitivity	$< \pm 0.1\%$ for 10% change in operating voltage
Load sensitivity	$< \pm 0.1\%$ for 50% change in load current
Reaction time	$f=50$ Hz / 0,25 s, $f=100$ Hz / 0,2 s, $f=1$ kHz / 0,1 s, $f=10$ kHz / 50 ms
Vibration resistance	IEC60068-T2-6 15g increased strain, characteristic 2 (10 ... 100 Hz)
Shock resistance (impact)	DIN IEC60068-T2-27 300 m/s ² with 18 ms dwell time
Climatic test	IEC60068-T2-30
Operating temperature	-20 °C ... +70 °C
Storage temperature	-45 °C ... +85 °C
Humidity	RH 96% maximum
ESD	IEC61000-4-2 ± 8 kV
Electromagnetic field	IEC61000-4-3 10 V/m $f=10$ kHz ... 2000 MHz, 80% AM @ 1 kHz 10 V/m $f=900 \pm 5$ MHz, 50% AM @ 200 Hz 10 V/m $f=1800$ MHz ± 5 MHz, 50% AM @ 200 Hz
Burst	IEC61000-4-4 ± 2 kV supply ± 1 kV sensor
Surge	IEC61000-4-5 sym. ± 1 kV ($R=2 \Omega$) asym. ± 2 kV ($R=2 \Omega$)
HF-susceptibility	IEC61000-4-6 3 V _{pp} 80% AM @ 1 kHz $f=0.01 \dots 100$ MHz
LF-susceptibility	IEC60553 3 V _{pp} 0.05 ... 10 kHz
Interference field intensity	Basis CISPR 16-1, 16-2 reduced characteristic
Connection	DIN46244 flat connector, gold-plated A6.3 x 0.8
Protection class	DIN EN60529 Body IP20, terminals IP00
Mounting	Snap-fit on top-hat channel or G-channel
Installed position	Any
Body material	Thermoplastic polyester, green, fire protection class V0
Weight	55 g
Standard supply	CE requirements complied with, DIN EN 61000-6-2, DIN EN 61000-6-4, DIN EN 50155, approved by GL, BV, LR, DNV

Type key / variants

Frequency version:	00	01	02
Output: 0 ... 10 V/DC	VF500-G1	VF501-G1	VF502-G1
Output: 2 ... 10 V/DC	VF500-G2	VF501-G2	VF502-G2
Output: 0 ... 20 mA	VF500-I1	VF501-I1	VF502-I1
Output: 4 ... 20 mA	VF500-I2	VF501-I2	VF502-I2

Please state upper range frequency in case of order (10 V/DC or 20 mA meets the ordered input frequency)

Device codes

V	Measuring transducer
F	Input signal
F	Frequency input for NORIS standard signal (sensor series FT / FA)
5	Type series
5	Type 5
00	Input range f_B / upper-range frequency f_E
00	$f_B: 10 \dots 100$ Hz, $f_E: 50 \dots 100$ Hz
01	$f_B: 20 \dots 1.000$ Hz, $f_E: 100 \dots 1.000$ Hz
02	$f_B: 200 \dots 10.000$ Hz, $f_E: 1.000 \dots 10.000$ Hz
G1	Variants
G1	Output 0 ... 10 V/DC, short-circuit-proof
G2	Output 2 ... 10 V/DC, short-circuit-proof
I1	Output 0 ... 20 mA
I2	Output 4 ... 20 mA
...	Maximum range frequency
...	Maximum range frequency in Hz (= 20 mA or 10 V)

V F 5 01 -I2 -352 (VF501-I2-352) order example

Other Data

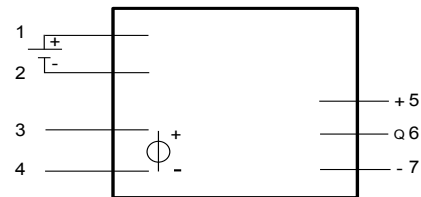
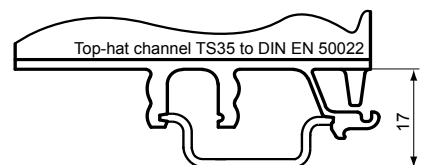
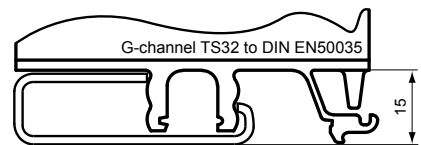
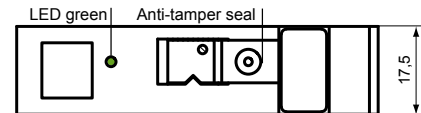
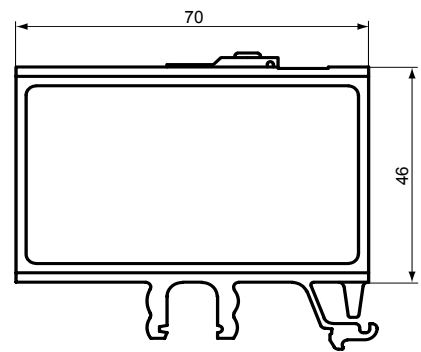

LED code

x= LED lighting
- = LED out
o= LED flashing

	Operating	LED green
x		x

NORIS
AUTOMATION

NORIS Automation GmbH
Muggenhofer Strasse 95
90429 Nuremberg
Germany

Tel.: +49 911 3201-220
Fax: +49 911 3201-150
sales@noris-group.com
www.noris-group.com