

**Instruction Manual**  
**No. 7435-50 Multiple Measuring System**  
**Model SK-5RAD-MR**

**SATO KEIRYOKI MFG. CO., LTD.**

3-4, Kanda-kajicho, Chiyoda-ku, Tokyo 101-0045 Japan

URL: <https://www.sksato.co.jp/en/>

As of 2023

Thank you for purchasing the multiple measuring system model SK-5RAD-MR.

- This product is designed to measure dry bulb and wet bulb temperatures. Do not use it for other purposes.
- Read this manual thoroughly before using. Keep the manual in a safe place for future references whenever necessary.

### **Warning**

The SK-5RAD-MR is not explosion-proof. Never use it in an atmosphere containing flammable gases.



#### **Beware of explosion!**

There is a risk of explosion. Take extreme care.

Should you have any questions, please consult with the local store where the device is purchased or with our service network.



### **Caution**

- Observe the following precautions to use this equipment correctly.
  - This is a precision equipment. Do not drop or apply impact or vibrations to it.
  - Never disassemble or modify the equipment. Doing so may result in failure.
  - Do not use this equipment in an area exposed to direct sunlight or near heaters. Doing so may not only prevent correct measurement but could also result in failure or casing deformation.
  - Do not use this equipment in an area subject to dust, flammable gas, explosive gas, corrosive gas (SO<sub>2</sub>, H<sub>2</sub>S, etc.), etc.
  - Using this equipment in an environment with electrical noise may produce an unstable display or an increase in measurement errors.
  - Do not use this equipment outside the measuring range. Doing so may result in failure.
  - This equipment is not waterproof and so must not be allowed to get wet.
  - Do not wash or wipe the equipment with solvents such as alcohol or thinner. If the equipment becomes dirty, dip a gauze pad or soft cloth in warm water containing neutral detergent, wring out the cloth, and then wipe the equipment with the cloth.
  - Do not forcibly pull, bend or bundle the cord or cable. Placing a heavy object on the cord or cable, or heating or scratching it may result in failure.
  - Before turning on the power, make sure that the AC power cord and sensor cable have been connected correctly, the sensor section has been set up and an SD memory card has been mounted.
  - This equipment employs a small brushed motor. Be sure to turn off the power switch when measurements are not being made. The service life of the motor is approximately 1,350 hours of operation. If this equipment is to be operated continuously for a long period of time, select a brushless motor when placing your order. The test results under the normal

temperature and humidity conditions demonstrate that the service life of brushless motors is at least 10,000 hours of continuous operation.

- Do not operate the touch panel with a pointed object such as a pen. Doing so may scratch the screen.



## Caution

- Be sure to observe the following precautions in order to use this equipment correctly.
  - Be careful to correctly wire the equipment. Otherwise, the equipment may fail.
  - We recommend the use of protective cover to prevent accidental contact with the wiring part.
  - Be sure to turn off the power supply of the equipment before starting any wiring work to prevent electrical shock.
    - (1) To prevent electrical shock, be sure to perform protective grounding before turning on the power to the equipment.
    - (2) Do not cut or disconnect the protective grounding wire.
    - (3) Do not turn on the equipment before connecting the wires or setting up the sensor.

Make sure that the power is off when connecting the wires.
  - Make sure that the power source conforms to the power supply voltage of this equipment.
    - (1) Power supply rating : 100 to 240 VAC, 50/60 Hz, 25 VA max.
    - (2) Operating voltage range : 85 to 264 VAC

Note: The power cord provided is exclusively used for 100 VAC. If the equipment is used with a different voltage, prepare a cable that matches the voltage and the shape of the power outlet.
  - Do not use unconnected terminals for any other purposes such as relays.
  - We recommend that the protective grounding wire is not shared with other devices. If shared, noise from the grounding wire may affect this equipment.
  - Do not operate this equipment in an area subject to flammable gas, explosive gas, corrosive gas, spattering water, or steam.

Installation location : Indoors

Altitude : No higher than 2,000 meters above sea level

Installation ambient : 0 to 50°C, 20 to 80% RH (no condensation)

Overvoltage category : Category II

Permissible exposure limits for contaminants : Level 2

Vibration : 10 to 60 Hz, 0.2 m/s<sup>2</sup>

Impact : Not allowed
  - This equipment has a built-in battery for a clock. If the battery replacement is required, contact the store where you purchased this equipment or our service network by all means.
  - Do not carry or move the equipment with the sensor and the paperless recorder connected. Doing so may cause them to fall, resulting in a very dangerous situation.

#### ■ Notes on product warranty

- If this equipment is used for the purposes other than hygrometer, the measurement accuracy cannot be guaranteed. Be sure to use this equipment only as a hygrometer.
- If the "Offset" or "Gain" settings are changed, the equipment will no longer be covered by the warranty including measurement accuracy.
- When mounting an SD memory card, make sure to insert it in the correct direction. Forcible insertion in the wrong direction may cause a trouble of card and this equipment. Any damage to the equipment due to this reason is not covered by the warranty.
- Note that any loss of or damage to the data stored on the SD memory card falls out of the warranty. Important data should be backed up to other media at regular intervals.
- For repairs or calibrations, contact the store where the product was purchased, or our service network.



#### **Caution**

SD/SDHC memory card is a trademark of Panasonic Corporation, SanDisk Corporation and Toshiba Corporation.

Excel is a registered trademark or trademark of Microsoft Corporation in the United States and other countries.

Other company names, product names, system names, etc. are trademarks or registered trademarks of their respective companies

### **Overview**

The operating principle of this equipment is based on the wet- and dry-bulb system, which is considered to be the most stable method for measuring relative humidity.

There are two temperature sensors; one is called a wet-bulb sensor that the bulb is wrapped with a wick and the other is called a dry-bulb sensor. The wick of the wet-bulb is moistened with water. When the moisture evaporates, heat is taken and the temperature of the bulb falls. In this situation, there is a relationship ("Sprung formula") between the latent heat of vaporization and the vapor pressure in the atmosphere where measurements are being made. The relative humidity can be obtained from this relationship.

In this equipment, a motor-driven forced ventilation device is incorporated in the sensor head to suck up air from the lower air intake tube (vent) through the temperature sensing section. This ventilation system quickly stabilizes the readings and has been used as a humidity standard device for a precise measurement.

This equipment is used not only in the meteorological observation but also in the places that strict humidity control is required as a standard instrument for relative humidity.

## Features

- This equipment can be easily operated using the touch panel.
- Measurement data can be stored on an SD memory card and then data can be managed and analyzed on a PC.
- A platinum resistance temperature sensor (PRT) is adopted. This PRT is highly reliable and ensures stable accuracy for a long period of time.
- This equipment displays the relative humidity and dew point using by computing functions.
- A brushless motor best suited for continuous operation can be installed on this equipment at option. (Customers must specify this option when placing an order.)

## Components

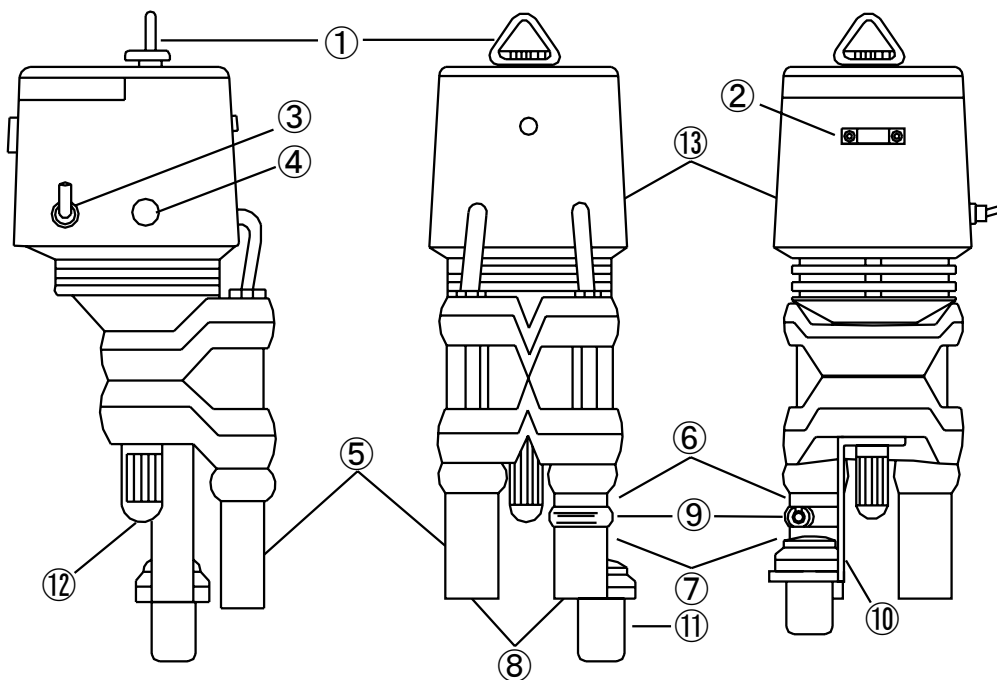

### • Sensor

- |   |  |
|---|--|
| ① Hanging ring  | : Used to suspend the sensor.  |
| <del>② Wall mounting bracket</del> (Removed from the latest version as of 2023) |  |
| ③ Power switch  | : Turns the DC motor on and off.   |
| ④ Sensor cable  | : Connected to the paperless recorder.   |
| ⑤ Air intake tube (for dry bulb)  |  |
| ⑥ Upper part of air intake tube (for wet bulb)                                  |  |
| ⑦ Lower part of air intake tube (for wet bulb)                                  |  |
| ⑧ Pt sensor (inside the ventilation pipe)                                       | : A temperature sensor.  |
| ⑨ Hook  | : Used to hold the wet-bulb wick in place.   |
| ⑩ Reservoir holder  | : Used to hold the water reservoir.  |
| ⑪ Water reservoir   |  |
| ⑫ Stand mounting screw  | : Used to install the sensor with the stand.   |
| ⑬ AC adapter connection port  | : For brushless motor specifications only<br>(to be specified when placing an order) |

● Paperless recorder

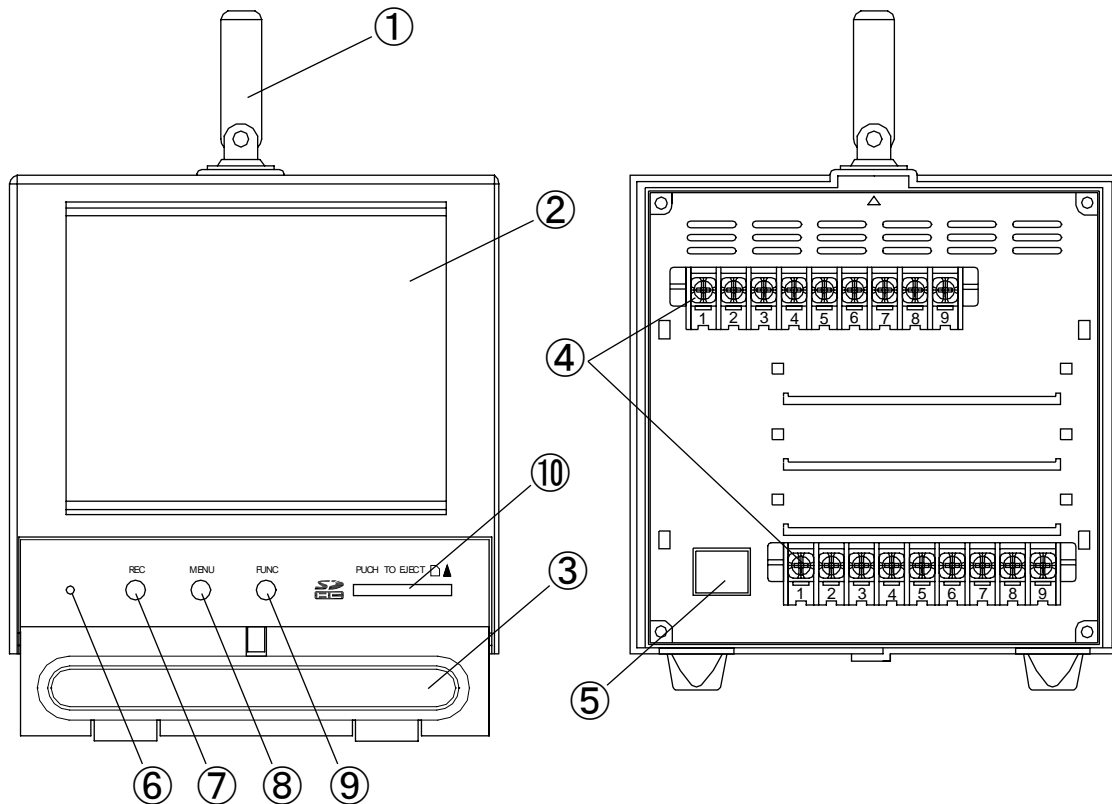

- ① Handle : Used to carry the recorder by hand  
\* Be careful not to drop the equipment when carrying or installing it.
- ② Display panel : An LCD touch panel. Measurement data or various parameters are displayed.
- ③ Button operation panel cover : A protective cover for the button operation panel.  
To open the cover, pull it toward you while pushing the two knobs downward.  
To close the cover, push it straight back in place while holding down the knobs.
- ④ Terminal block : Used to connect the power cord and sensor cable.
- ⑤ LAN connector : Used to connect the LAN cable.
- ⑥ Status indicator lamp : Indicates the power supply status (ON/OFF) or recording status.
- ⑦ **REC** button : Used to start or stop recording.
- ⑧ **MENU** button : Used to display the menu screen.
- ⑨ **FUNC** button : Used to switch the display mode. By pressing the button, the operation performed can be changed according to your needs.
- ⑩ SD memory card slot : Used to insert an SD memory card.

## Wiring

### 1. Connecting the sensor and the paperless recorder

Remove the two hooks on the right and left sides of the protective cover, and then remove the cover from the main unit.

Connect the sensor cable to the terminal block as shown in the figure and table below.

Remove the screws from the terminal block first, insert the cable terminals and then remount and retighten the screws on the terminal block.

Note: For the recorder terminal numbers, check the printed label on the protective cover.

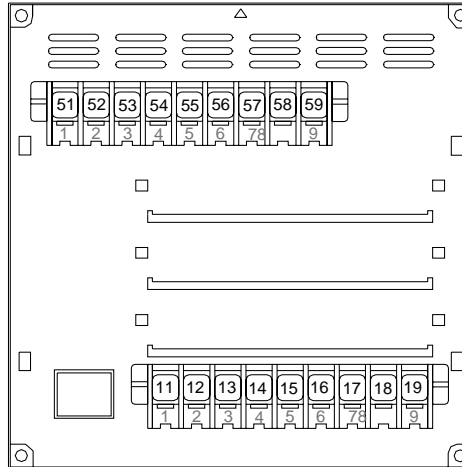

Recorder cable terminal No.	51	52	53	54	55	56	57	58	59
							FAN power supply		
								+	-
Wire color (R terminal color)								Yellow (Red)	Green (Blue)

Recorder cable terminal No.	11	12	13	14	15	16	17	18	19
	Dry bulb temperature CH1			Wet bulb temperature CH2					
	A	B	B	A	B	B			
Wire color (R terminal color)	Red (Red)	White (Red)	Black (Red)	Orange (Blue)	Blue (Blue)	Brown (Blue)			

Note: For brushless motor specifications, terminal numbers 58 and 59 are not connected.

### 2. Connecting the AC power cord

Connect the AC power cord to the terminal block as shown in the table below.

Recorder cable terminal No.	51	52	53	54	55	56	57	58	59
	Power requirement								
	L	N	Ground connection						
Wire color (R terminal color)	Brown (Red)	Blue (Red)	Yellow (Blue)						

### 3. Replace the two hooks on the right and left sides of the protective cover, and remount the cover on the main unit. The power cord used for 100 to 250VAC is provided, however prepare the power

outlet that matches each voltage.

## **Installing the equipment**

### ① Installing the sensor

The sensor can be installed with a pre-attached stand, or hung by using the hook on the sensor head.

A tripod for hanging the sensor is optionally available.

Caution: Do not to hold the sensor by hands at measurement for obtaining correct readings.  
Use the banding bands (accessories) to secure the stand and the sensor cable when using the stand.

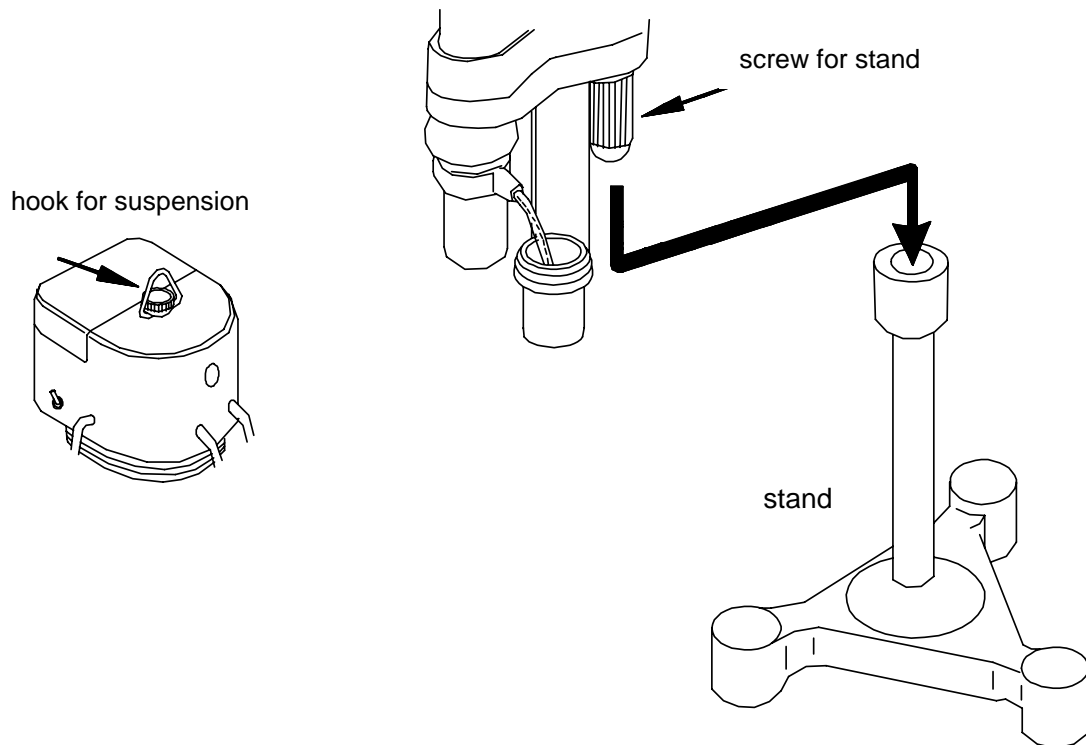



## ② Installing the paperless recorder

Install the paperless recorder in the places as following.

- Places free from mechanical vibrations or impact  
(Vibration: 10 to 60 Hz, 0.2 m/s<sup>2</sup>, impact: not allowed)
- At dust-free atmosphere
- Places free from flammable gas, explosive gas and corrosive gas (such as SO<sub>2</sub> or H<sub>2</sub>S)
- Places within an ambient temperature range of 0 to 50°C and with small temperature variation.
- Places away from direct high radiant heat and direct sunshine.
- Places free from water droplets and condensation within a humidity range of 20 to 80%rh.
- Well-ventilated places to diffuse heat from the equipment
- Places away from electromagnetic waves from wireless equipment or mobile phones
- Level places (forward tilt: 0°, backward tilt: between 0° and 30°)

### Water supply method



#### Caution

- When handling the string of wick, use a pair of tweezers or wash your hands with soap to prevent the transfer of dirt (such as grease, salt or acid).
- If the wick or the sensor section becomes dirty, accurate measurements cannot be made. Use distilled water for the water supply whenever possible.
- Do not wet the inner wall of the air intake tube. Otherwise, the wet bulb temperature will become unstable, which may result in measurement errors.

1. Carefully pull the string from the guide above the water reservoir and put the string into water reservoir.

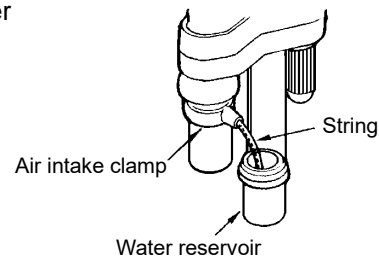

2. Fill the water reservoir to four-fifths with distilled water, using the water bottle supplied (Approx. 13 cc).  
Pour water to the string so that the temperature bulb also gets wet.

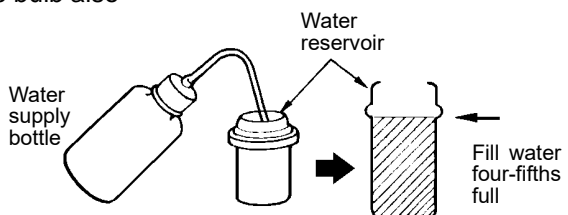

As for the replacing the wet bulb wick, refer to the "Maintenance" on the page 22.

## Starting measurement



### Caution

- Before turning on the power, make sure that the AC power cord and the sensor cable have been connected correctly, the sensor section has been set up, and an SD memory card has been mounted.
- When mounting an SD memory card, make sure that it has been inserted all the way in the correct direction. Forcible insertion in the wrong direction may cause the card and this equipment to fail. Any damage to the equipment due to this reason is not covered by the warranty.
- This equipment employs a small brushed motor so be sure to turn off the power switch and unplug the AC power cord from the power outlet when measurements are not being made. Continuously operating the equipment with the power on causes the motor brushes to wear down. The service life of the motor is approximately 1,350 hours of operation.

Note: If this equipment is to be operated continuously for a long period of time, select a brushless motor when placing your order. The results of our tests conducted under normal temperature and humidity conditions demonstrate that the service life of brushless motors is at least 10,000 hours of continuous operation.

- If the motor on the sensor needs to be repaired or replaced due to its service life expiring, contact the store where the equipment was purchased, or our service network.
- If measured values are abnormal such as measured value exceeds the measuring range or the dry-bulb temperature is lower than the wet-bulb temperature, "B.OUT" or "INVALID" will be displayed. If this happens, restore the equipment to its normal state within the measuring range, checking the situation of the wick and water supply, and checking that the terminals have been connected correctly.

If the problem persists, the equipment may have failed. In this case, immediately stop using the equipment and contact the store where the equipment was purchased, or our service network.

### ① Insert an SD memory card into the slot

Make sure that an SD memory card it has been inserted all the way in the correct direction.

### ② Check that all the wiring is correct, and then plug the AC power cord into the power outlet and turn on the power. The screen lights up and then readings will be displayed in approximately 10 seconds.

Note: If brushless motor is used, connect the AC adapter provided to the AC adapter port in the upper of the sensor section, and set the power switch to the upper side to turn on.

### ③ Set the power switch to the upper side to turn on the power.

The ventilation fan starts rotating.

Allow the sensor to warm up for at least five minutes.

In particular, if the sensor has been moved from a place where the ambient environment is very different, allow enough time for the sensor to become acclimated to the surrounding atmosphere before using the sensor.

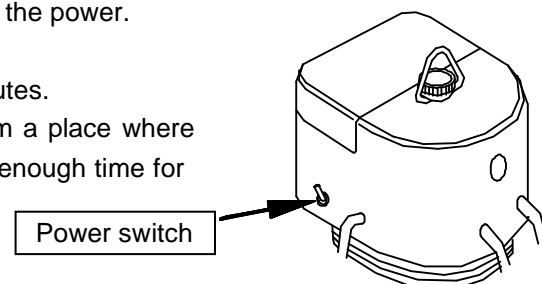

- ④ Start measurement when the readings of the dry-bulb temperature and wet-bulb temperature have become stable.

Note: Once this equipment has become stable, it can detect subsequent changes of the temperature and humidity environment almost in real time. However, the equipment may be unable to respond to sudden environmental changes.

- ⑤ To finish measurement, set the power switch to the lower side to turn off the power, and unplug the AC power cord from the power outlet.

### **Starting recording**



#### **Caution**

- Do not turn off the power or remove the SD memory card during recording. Doing so may result in data being damaged or lost. Be sure to remove the card from the equipment after the stop of recording.
- While the SD memory card is communicating with this equipment, the status indicator lamp is flashing and the SD memory mark is lit in red in the memory status display section. During this state, never remove the card. Doing so may damage the data and cause the equipment to fail.
- You can freely change the recording settings as necessary. When the settings are changed, it is recommendable to save the default settings to an SD memory card beforehand since the original settings is not be retained.
- Refer to "Saving to an SD Memory Card" on page 17 for information on how to save the settings to an SD memory card.

- ① Open the button operation panel cover on the front of this equipment and press the **REC** button. A message "Record starts" is displayed on the screen, the status indicator lamp is flashing, and recording will start.

Note: When you change the recording settings, refer to "Setting up recording" on page 18.

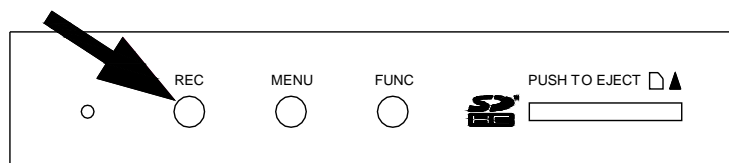

- ② To stop recording, press the **REC** button again.

A confirmation window is displayed. Either press the **REC** button or touch the **Stop** key in the window. The recording will stop.



After the recording has stopped, the SD memory card communicates with this equipment to store the data. Do not remove the SD memory card until the data has been completely saved. The memory status indicators will remain red while data is being saved, and will turn light blue when data has been completely saved.

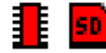
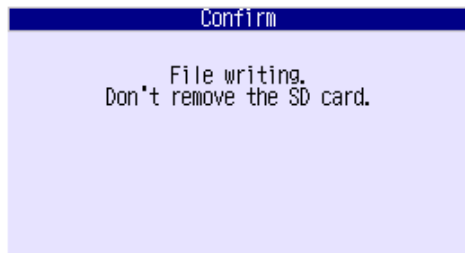

Memory status display section

Left: Internal memory status indicator

Right: SD memory card status indicator

## **Software**

Software that can be used to analyze recorded data and set up the equipment comes with this equipment. Using this software makes it easier to do these tasks.

- Recommended operating environment

- OS : Microsoft Windows XP/Vista/7 (32-bit, 64-bit)
- Hard disk : 500 MB or more free space
- Display : resolution :1024x768 pixels (XGA) or more

For details on how to use the software, refer to the instruction manual of the Parameter Loader and Data Viewer that are stored on the CD-ROM provided.

- Installation

Turn-off any active applications currently running before installing this software. If the previous version has been installed, delete the software using "Add/Remove Programs" in the Control panel.

- ① Insert the CD-ROM into the CD-ROM drive.

The installation window is automatically displayed. Follow the procedure to the instructions displayed on the screen. If the installation window is not displayed, double-click "index.htm" to open the installation window, and follow the procedure.

- ② The message "Data display setup is completed" is displayed and the installation procedure is now complete.

- Data Viewer

This software enables the recorded data stored on the SD memory card to be viewed on the PC via the adapter or FTP communications.

- ① Select [All Programs] – [VM7000A] – [Data Viewer] from the [Start] menu. The Data Viewer will start.

- ② Connect the SD memory card to the PC, and copy the recorded files to the PC from the [Recorder] – [Data] folder.

- ③ Select the recorded file to be viewed by [File] – [Open file] from the menu. The same operation can be performed by selecting the [Open] icon on the toolbar.

- Parameter Loader

This software enables various settings for the paperless recorder to be performed on the PC. The Parameter Loader can be used to read the settings data stored on the SD memory card, or create or change settings data.

- ① Select [All Programs] – [VM7000A] and then [Parameter Loader] from the [Start] menu. The Parameter Loader will start.
- ② Select [Open] from the [File] menu, and select the desired recorded file in the [Open] window.  
The same operation can be performed by selecting the [Open] icon on the toolbar.
- ③ Settings data that has been created should be saved in the [Prm] subfolder of the [Recorder] folder on the SD memory card. Settings data can be loaded into this equipment.

### **How to use the paperless recorder (Quick Reference)**

This section explains the preparation and operation procedures for storing measurement data. For details on how to use the paperless recorder, refer to the instruction manual for the paperless recorder that is stored on the CD-ROM provided.



#### **Caution**

##### Paperless Recorder

- This equipment has optional functions, however these cannot be used.
- The [Engineering] key on the menu screen is used for the factory adjustment only. Do not change the settings for these functions.
- Note that any loss of or damage to the data stored on the SD memory card falls out of the warranty.
- This equipment allows you to change settings or format data as necessary. We recommend saving important data and settings to other media at regular intervals. Refer to "Saving to SD Memory Card" on page 17 for information on how to save the settings to an SD memory card.
- Do not operate the touch panel with pointed objects such as a pen. Doing so may scratch the screen.
- There may be unevenness in brightness due to LCD characteristics, but this is not any faults.
- When other functions need to be used, thoroughly read the instruction manual about the handling of this equipment stored on the CD-ROM before using those functions.
- If this equipment is used for anything other than its intended purpose, the measurement accuracy cannot be guaranteed. Be sure to use this equipment only as a hygrometer.
- If the "Offset" or "Gain" settings have been changed, the equipment will no longer be covered by the warranty terms including measurement accuracy.



## Caution

### SD Memory Card

- Normally, commercially available SD memory cards can be used without being formatted. If SD memory cards are to be formatted again, format them using this equipment. If formatted using the PC standard function, the SD memory card may not operate correctly.
- When mounting an SD memory card, make sure that it has been inserted all the way in the correct direction. Forcible insertion in the wrong direction may cause the card and the equipment to fail. Any damage to the equipment due to this reason falls outside the scope of the warranty.
- Do not turn off the power or remove the SD memory card during recording. Doing so may result in failure to record the data or damage the previously stored data. Be sure to stop recording before removing the SD card.
- While the SD memory card is communicating with this equipment, the SD in the memory status display section is lit in red. In this state, never remove the SD memory card.
- MiniSD and MicroSD memory cards cannot be used. If an adapter for MiniSD or MicroSD is used for these cards, there is a risk of not being able to remove the SD memory card.
- This equipment complies with SD and SDHC standards.

#### Storage capacity

SD standard : 2 GB max.

SDHC standard: 32 GB max.

- We have verified that the following SD memory cards work well with this equipment:  
SD memory cards (1 to 32 GB) manufactured by Panasonic Corporation  
SD memory cards (1 to 32 GB) manufactured by SanDisk Corporation

### • Operation buttons

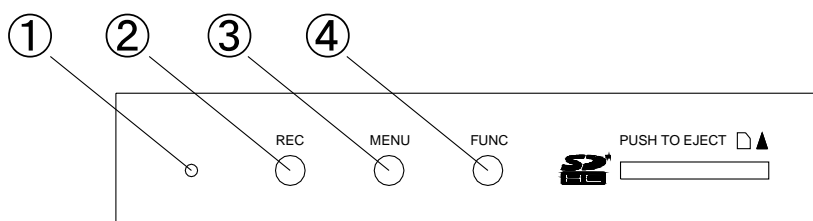

① Status indicator lamp - This lamp indicates the status of this equipment-

Lit : The power is on and recording is stopped.

Flashing : The power is on and recording is in progress.

Flashing w/high-speed: The power is on and data is being written to the SD memory card.

Lights out : The power is off.

② **REC** button - This button is used to start or stop recording-

③ **MENU** button

- The menu screen is displayed. When recording is stopped, this is used to select to continue recording. For the details, refer to "Menu screen" on page 16.

- ④ **FUNC** button - "Change display" function is set by default-  
By pressing this **FUNC** button," Change display", "Capture", "Message", " Addition reset", and "OFF" are selectable.

Note: The function assigned to the FUNC button can be changed by selecting [Device/Other] and then [FUNC key] from the **System** screen.

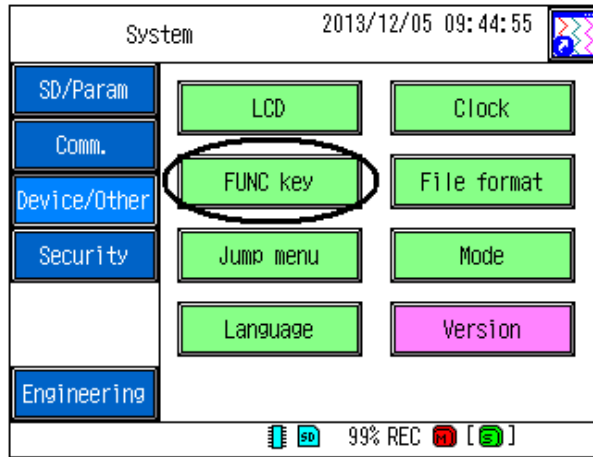

• **Data display screen**

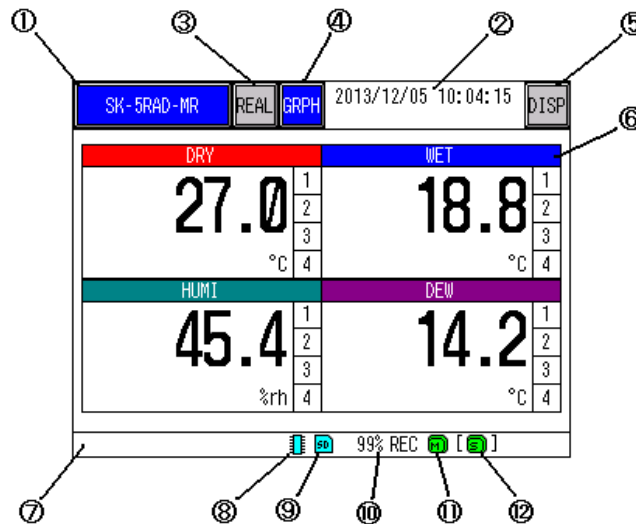

- ① Group screen title : This area displays the group screen title. Touching this area enables the screen title to be changed.
- ② Time display : This area displays the current date and time.
- ③ Trend changeover : This area is used to switch the type of trend screen (REAL or HIST).  
Note: This area is displayed in gray if the settings prevent the type of trend screen from being selected by touching the screen.
- ④ Graph type : This area is used to switch the display content of the data display area.  
The display can be switched between digital display and event history.  
Note: The screen to be switched differs depending on the settings for graphs displayed.

- ⑤ Display switchover : This area is used to switch the screen display method. If this area is touched when the menu screen is displayed, the display will return to the screen displayed before the menu screen.

Note: This area is displayed in gray if the settings prevent the screen display method from being selected by touching the screen.

- ⑥ Data display area : This area displays the dry-bulb temperature (°C), wet-bulb temperature (°C), relative humidity (% RH), and dew point temperature (°C). Numbers 1 to 4 on the right of the measured values are alarm numbers. When an alarm occurs, the corresponding alarm number will turn red. Touching a title (such as "DRY") for two seconds or more will display a list of settings.

- ⑦ Event display area : This area displays event information such as beginning to record and record ended.

- ⑧ Internal memory : This indicator shows the status of the internal memory. It is lit in red while the internal memory is being accessed.

- ⑨ SD memory card status display

: This indicator shows the status of the SD memory card using different colors.

- . Gray : No SD memory card is mounted  
(or an SD memory card that is mounted can be removed)
- . Light blue : An SD memory card has been mounted.
- . Red : The equipment is communicating with the SD memory card  
(Data is being written to the SD memory card, for example)

- ⑩ Memory usage display (with percentage)

- . When an SD memory card is mounted: Free space in the SD memory card is displayed.
- . When no SD memory card is mounted : Free space in the internal memory is displayed.

- ⑪ Main recording display - This indicator shows the status of the main recording-

- . Green: Main recording is not in progress.
- . Red : Main recording is in progress.

- ⑫ Sub-recording display - This indicator shows the status of sub-recording-

- . Green: Sub-recording is not in progress.
- . Red : Sub-recording is in progress.

\* The following table shows the main default settings.

- These settings can be changed using this equipment or the software (Parameter Loader) provided. However, the original settings will not be retained, so we recommend saving the original settings to an SD memory card before making changes.
- Refer to "Saving to SD Memory Card" on page 16 for information on how to save the settings to an SD memory card.
- If the input channels are changed, the equipment cannot be used as a hygrometer. Be careful when changing the settings.



Item	Settings
Input channels	CH1 : Dry-bulb temperature (°C) Pt100-2 CH2 : Wet-bulb temperature (°C) Pt100-2 CH13 : Relative humidity (%RH) CH14 : Dew point temperature (°C) Note: CH13 and CH14 are calculation channels.
Group	Group 1: HYGRO-STATION-MR
Alarm	OFF
Recording	Recording interval : 1 minute (File recording: 1 day) Memory overwriting : OFF (Data is not overwritten when the SD memory card becomes full.) Storage format : CSV data and binary data Recording type : Instantaneous value
Graph display	Digital
FUNC button	Screen switching

• Menu screen

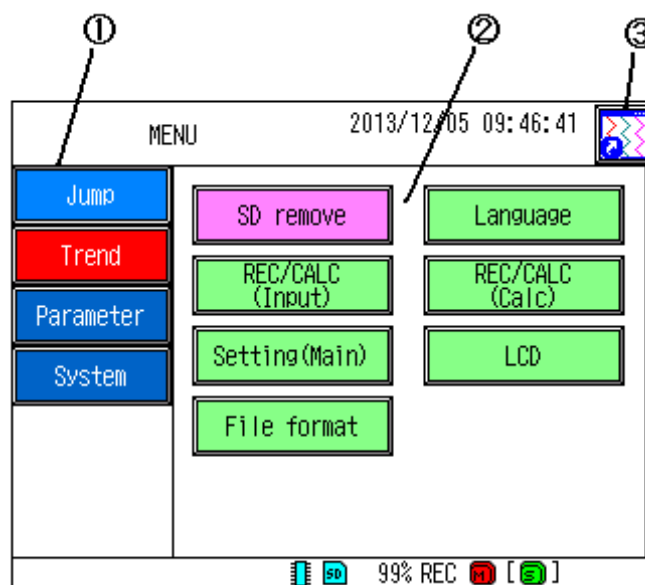

① Main menu

Touching one of the main menu items displays the submenu.

② Submenu

Touching one of the submenu items displays the corresponding setup screen.

Note: The submenu items displayed from the menu screen can be freely set by selecting [Device/Other] and then [Jump menu] from the **System** screen.

The following table shows the default settings.

SD Remove	Touch this button to remove the SD memory card. This button will terminate communications with the SD memory card.
Language	Touch this button to change the language displayed on the screen. Select either English or Japanese.
REC/CALC (Input)	Touch this button to set the recording type for dry-bulb temperature (CH01) and wet-bulb temperature (CH02).
REC/CALC (Calc)	Touch this button to set the recording type for relative humidity (CH13) and dew point temperature (CH14).
Setting (Main)	Touch this button to set up recording. Items such as the recording interval can be set here.
LCD	Touch this button to set the screen brightness and automatic sleep mode. Setting the automatic sleep mode can extend the life of the monitor screen. If the screen looks dark, use this menu item to adjust the brightness.
File format	Touch this button to set the storage format of recorded data. Select either binary data or CSV data.

### ③ Back button

Touching the back button returns the display to the screen displayed before the menu screen.

## • Saving to SD Memory Card

① Touch the [MENU] button to display the menu screen.

② Touch [System] in the main menu.

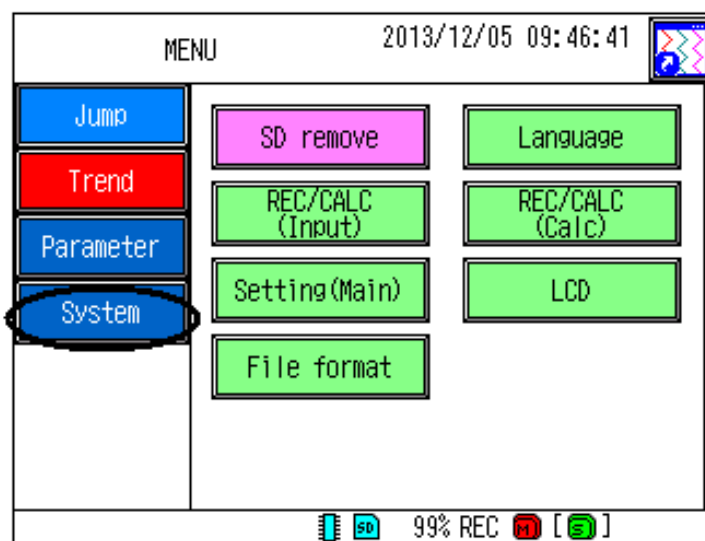

- ③ Touch [SD/Param] in the main menu and then [Param save] in the submenu.  
The settings will be saved to the SD memory card.

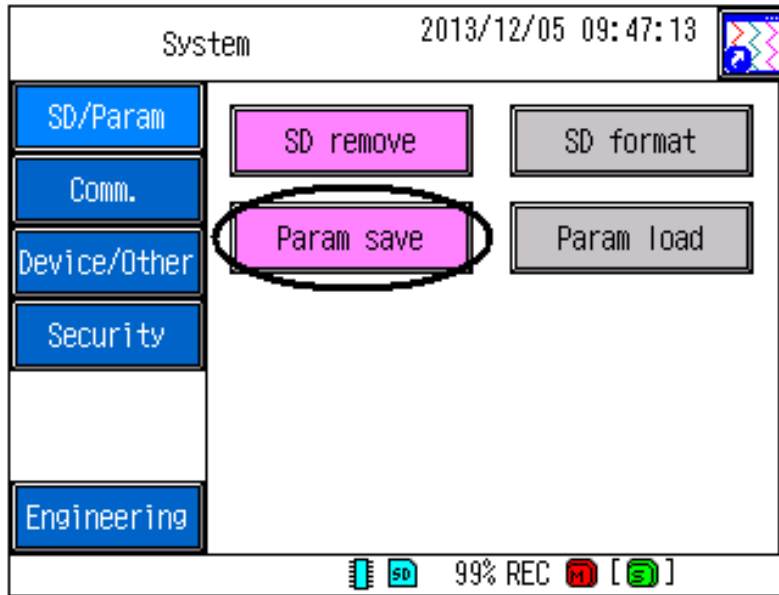

\* Settings are saved in the [Prm] subfolder of the [Recorder] folder on the SD memory card. These folders are automatically created when an SD memory card is mounted on this equipment.

\* To load the stored settings into the equipment, touch [Param load]. Selecting the desired settings from all the stored settings loads the settings into the equipment.

● **Setting up recording**

- ① Touch the [MENU] button to display the menu screen.

- ② Touch [Setting (Main)]. The setup screen will be displayed.

Note: The setup screen can also be displayed by selecting [Parameter] and then [Record].

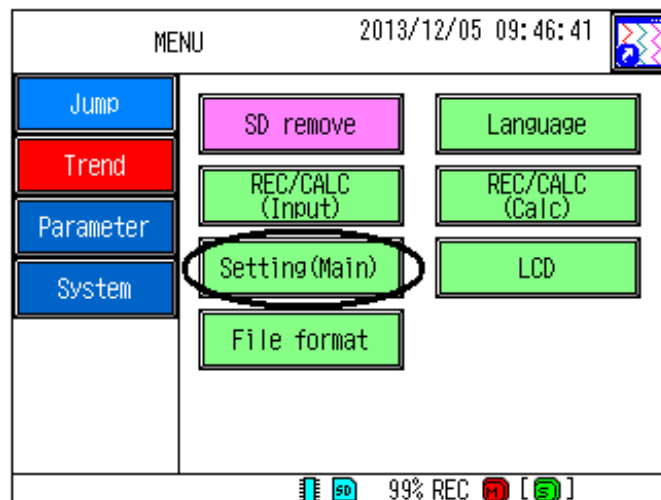

③ Set up recording.

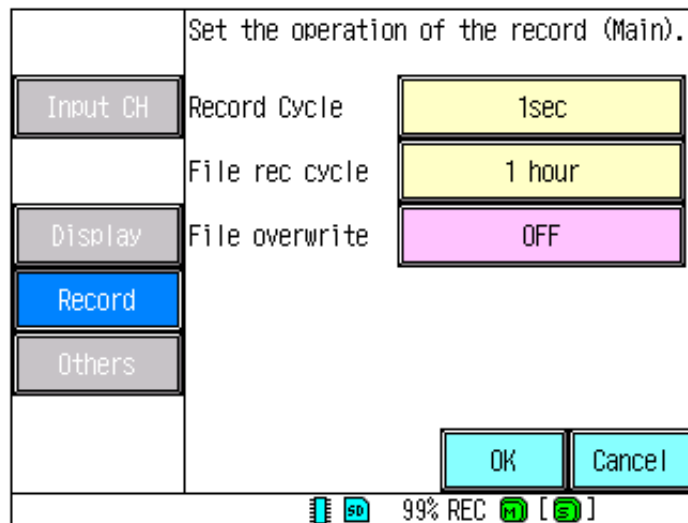

[Record Cycle]: Set the recording interval for main recording.

\* "100 ms" can only be selected for sub-recording. For sub-recording, refer to the instruction manual stored on the CD-ROM.

[File rec cycle]: Set the interval for recording measurements to a file.

\* The selectable range varies according to the specified value in [Record Cycle].

[File overwrite]: Select to overwrite data or not when the SD memory card becomes full.

ON : Deletes old recorded data in chronological order and continues recording when the memory becomes full.

OFF : Stops recording when the memory becomes full.

④ Touch [REC/CALC (Input)] on the menu screen.

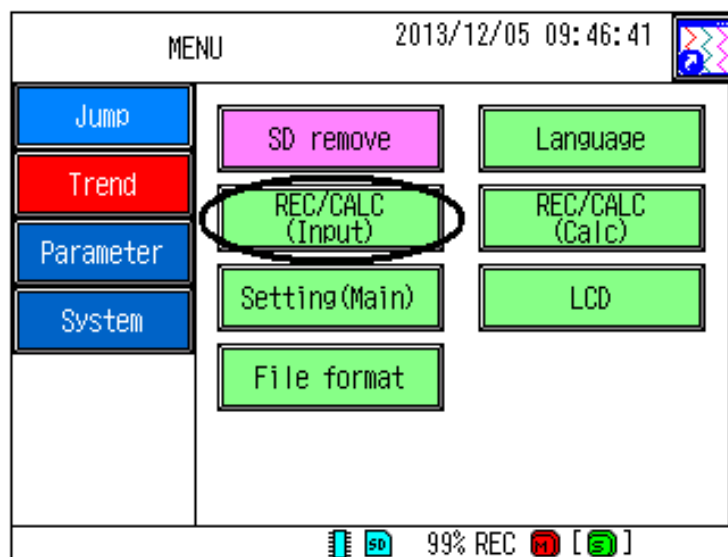

- ⑤ Touch [Record type] and specify the type of data to be recorded.  
 For [Channel], dry-bulb temperature is set **CH01** and wet-bulb temperature is set **CH02**.

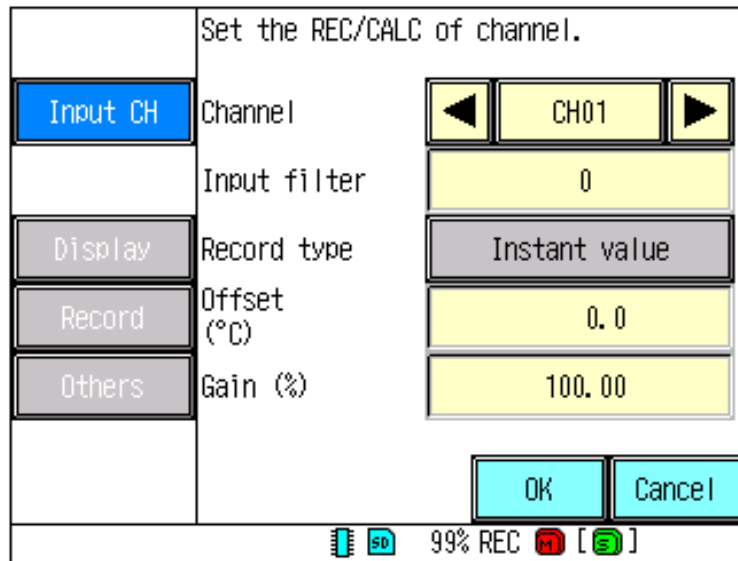

- Instant value : Records data at recording intervals.
- Average : Records the average value of all values measured during each recording interval.
- Max/Min : Records the maximum and minimum values of all values measured during each recording interval.  
 Example : If the recording interval is one second, the maximum and minimum values of 10 values measured at intervals of 100 ms will be recorded.
- OFF : Trend data only is recorded on the [Trend] screen and is not recorded in the SD memory card.

 <b>Caution</b>
<ul style="list-style-type: none"> <li>• The [Input filter], [Offset] and [Gain] settings affect measurement accuracy. We recommend that these settings not be changed. If any of these settings are changed, the accuracy assurance will no longer be guaranteed.</li> </ul>

- ⑥ Likewise, use [REC/CALC (Calc)] to set the recording type for relative humidity and dew point temperature. **CH13** is set for relative humidity measurement, and **CH14** is set dew point measurement.

⑦ Touch **File format** on the menu screen.

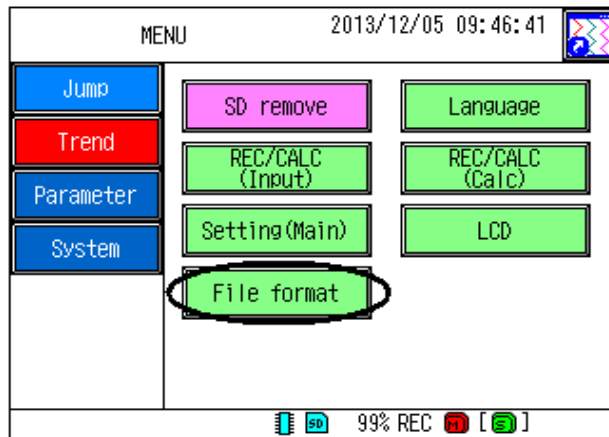

⑧ Select the desired storage format in the **File format** section.  
After the setting has been made, touch **OK** to save the setting.

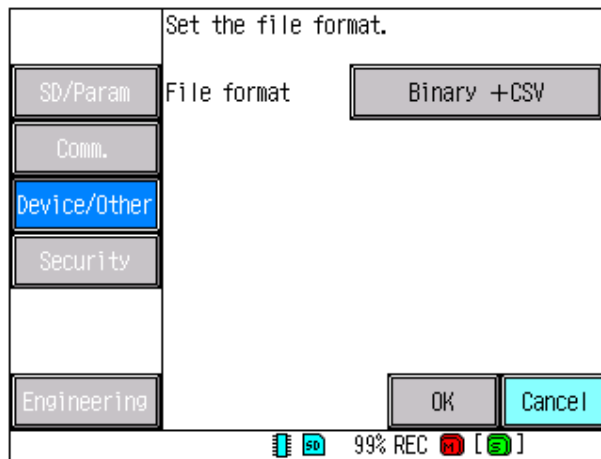

- Binary : This format enables recorded data to be read using the data analysis software provided.
- Binary+CSV: This format enables recorded data to be read using commercially available spreadsheet software such as Excel.

#### • Data files

Inserting an SD Memory Card into this equipment automatically creates a folder named "Recorder" where four subfolders will be created. The subfolders are as follows:

- ① Cap: Contains image files (bmp) that are captured. Up to 100 image files can be stored.
- ② Data: Contains recorded data. When recording starts, a new folder is created. During recording, a new folder is created at regular intervals.

\* Folder name: xxxx\_YYMMDDHHmmss

xxxx: Record number (four digits)    YY : Year (two digits)    MM : Month (two digits)

DD : Day (two digits)                    HH : Hour (two digits)    mm : Minute (two digits)

"YYMMDDHHmmss" indicates the time when recording started.

\* The types (extensions) of files stored are as follows:

- Main recording management file (dm)  
This file contains the main recording start and end times, and link information.  
A single file manages 50 dmt files.
- Main recording trend file (dmt)  
This file contains measurement data where the main recording has been split according to the recording interval.
- Main recording event file (dme)  
This file contains event logs such as alarms and messages.
- Sub-recording management file (ds)  
This file contains the sub-recording start and end times, and link information.
- Sub-recording trend file (dst)  
This file contains measurement data where the sub-recording has been split according to the recording interval.

③ Etc: Contains text tables (txt) that can be accessed by using the listed keys in the character input screen, as well as parameter settings files (dps).

④ Prm: Contains settings files (dps).

These files can be saved and read by this equipment. Settings data created with the software provided (Parameter Loader) must be stored in this folder.

#### \* Data analysis

Installing the analysis software (Data Viewer) from the CD-ROM onto the PC enables data analysis to be performed. For details on how to use this software, refer to the instruction manual stored on the CD-ROM.

Data saved in CSV format can be edited using commercially available spreadsheet software such as Excel.

## **Maintenance**

### • Replacing the wick



#### **Caution**

- Before using this equipment, be sure to check if dust or dirt is not adhering to the wick. If it is dirty, replace it to new one.
- Regularly check the water level in the water reservoir and check if the water is clean. If the water level is too low or the water is dirty, measurement errors may occur. It is recommended to replace the wick and water, and clean the water supply pot once a week.
- When handling the wick, use a pair of tweezers or clean your hands with soap to prevent the transfer of dirt (such as grease, salt or acid). Adhering dirt such as grease or salt may result in measurement errors.

1. Remove the water reservoir by pulling horizontally the air intake clamp, and pull down the air intake tube (lower part).

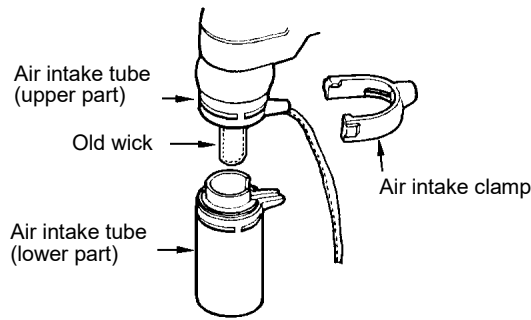

2. Clean the dust on the sensing part (at 30 mm from the top of PT sensor) with alcohol or like. If the old wick is on, remove it. If the new wick is put on the unclean sensing part, the wet bulb indicates temperature higher than actual value.
3. Use forceps to open the top of wick and attach the wick to the sensing part.

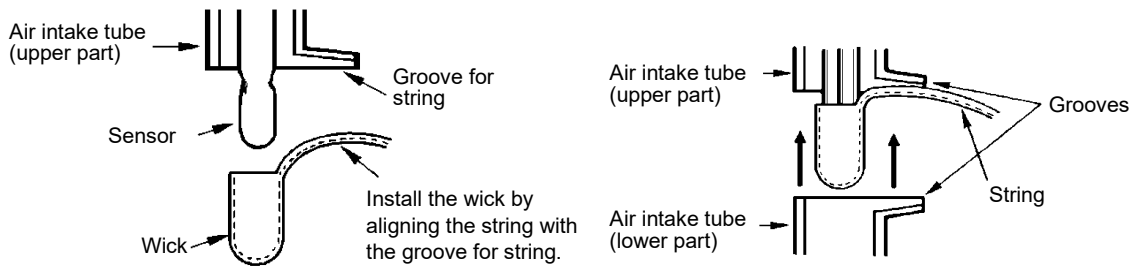

4. Let the string align along with the groove for string and join the upper and lower sections of the air intake tube. At that time, don't let the string get stuck or caught between the housing and air intake tube, between the clamp and air intake tube or in the grooves.
5. With the upper and lower sections of the air intake tube joined, locked it with the air intake clamp. Let the string through the groove for string. Attach the clamp in a way that the tab of the air intake clamp (convex part) is placed and aligned with grooves of the upper and lower sections of the air intake tube. At that time, don't let the string get stuck or caught between the housing and air intake tube, between the clamp and air intake tube or in the grooves.
6. Reattach the water reservoir to the reservoir holder, and place the string into the reservoir.

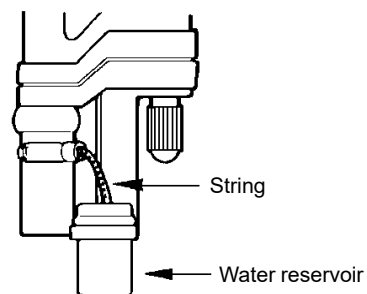

#### ●Using gauze instead of the wet bulb wick

Using gauze is an alternative to using the standard wicks when more accurate measurement is required at the state of lower than 25%RH.

1. Remove the old wick as shown in (1) (2) "Replacing the wick" on page 22.
2. Prepare the gauze and a thread made of cotton fiber. (We do not recommend a synthetic fiber.)  
Boil the gauze and cotton thread in soapy water, rinse the materials with distilled water to remove soap residues and oils.



- Cut a piece of gauze large enough to fit around the bulb (100 x 25 mm), and dampen it with distilled water. Extend the gauze about 10mm from the end of the bulb, and wind the gauze around the sensing part without making wrinkles.

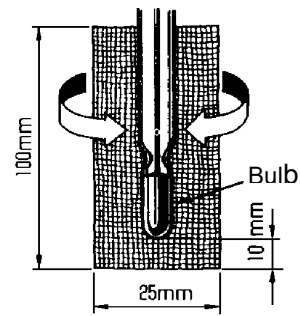

- Use cotton thread to tie the gauze firmly around the sensing part. (about 30mm from the tip of the bulb)

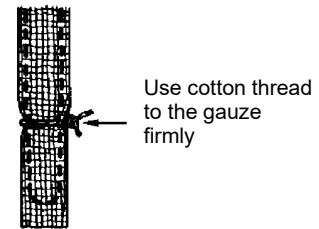

- Tie of the end of the gauze with another piece of tread. The knot should be snug.

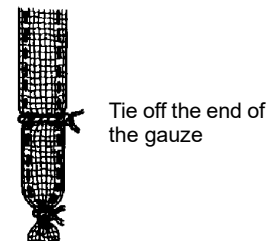

- Cut off the gauze about 2 or 3 mm beyond the end of the sensing part.

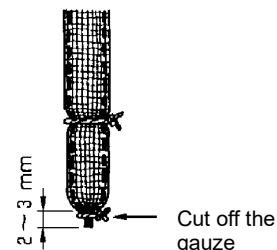

- Carefully pull out and remove the horizontal threads (woofs) of gauze above the hollow of the sensing part, leaving only the vertical strands (warps). Make a string by binding the remaining wraps of gauze.

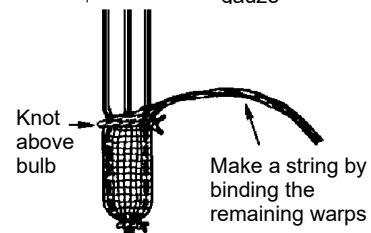

- Put back the lower part of air intake tube, clamp, and insert the string into the water reservoir. Follow steps 4, 5, 6 in "Replacing the wick".

## **Cautions**

- On interval of water supply

Duration of continuous operation with a supply of water differs depending on the circumstances where the instrument is used. Be careful about water level of feed water tank referring to the following table 1. Refer to the following chart just for a rough standard.

	Lower than 40%rh	Higher than 40%rh
Lower than 15°C	about 20 hours	about 30 hours
15 to 35°C	about 25 hours	about 35 hours
35 to 50°C	about 15 hours	about 20 hours

- On measuring range for continuous measurement (within 24 hours) and measuring area

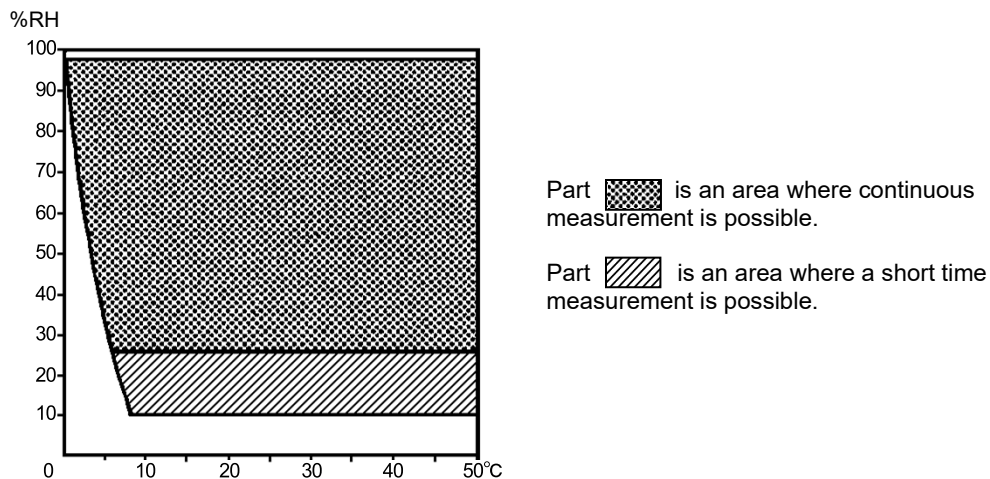

- **Storage**

When you do not use this equipment for a long period of time, please all throw away the remaining water in a water reservoir, and keep it in the place where there is little humidity and sunlight does not hit directly.

Storage condition: 0 to 50°C, less than 85%rh (no condensation)

- **Motor longevity (Motors are consumables)**

This equipment employs a small brushed motor. So be sure to turn off the power switch on the sensor and unplug the AC power cord from the power outlet when measurements are not being made. The service life of the motor is approximately 1,350 hours of operation. If the motor needs to be replaced due to aging, contact the store from which the equipment was purchased, or our service network.

For the continuous operation for a long period of time, select a brushless motor at ordering. The test of the service life of brushless motors was conducted under normal temperature and humidity conditions. In the result, at least 10,000 hours of continuous operation were demonstrated.

- **Cleaning**

Observe the following cleaning rules:

- Wipe the body using a dry cloth.
- Do not use organic solvents.
- Turn off the power completely before cleaning.

- **Power supply inside the paperless recorder**

This equipment has a battery for internal clock. If the clock is reset when the power is turned on, the built-in battery has been already exhausted and must be replaced. The built-in battery can be replaced only by us. Contact the store from which the equipment was purchased or our service network.

## Specifications

Product name		Multiple Measuring System for Temperature and Humidity with Paperless Recorder			
Model		SK-5RAD-MR			
Cat. No.		7435-50			
Elements		Dry Bulb Temperature	Wet Bulb Temperature	Relative Humidity	Dew Point Temperature
Range	Measurement	5.0 to 50.0°C	5.0 to 50.0°C	-	-
	Operation	-	-	0.0 to 99.9%rh	-40 to 50.0°C
	CH	CH01	CH02	CH13	CH14
Accuracy	Measurement	±(0.1rdg + 0.2°C)		-	-
	Operation	-		±(0.1rdg+1 digit)	±(0.1rdg+1 digit)
Compatibility		none			
Ventilation speed		Faster than 3m/sec.			
Detective Sensor		Pt100	Pt100	---	
Display	Monitor	5.7 inches TFT LCD touch panel			
	Life time	life time of back light: 50,000 hours			
Recording	Period	can be select from 1 sec to 60 min			
	Media	SD memory card (SD/SDHC)			
	Format	CSV, Binary data			
	Capacity	Internal memory: 100MB External memory: SD memory card SD (max 2GB) / SDHC (max 32GB)			
Water resistance		JIS C 0920 IP65 * Only for the front of the display with the use of packing for the panel mount.			
Power Requirements		100 to 240VAC ±10% 50/60Hz 25VA MAX (Battery for internal clock is built-in)			
Motor		Brushed motor : 1350 hours Brushless motor (option) : 1 year			
Operation ambient		Recorder: at 0 to 50°C less than 85%rh (no condensation) Sensor : at 5 to 50°C (without freezing on wet bulb) less than 85%rh (no condensation)			
Material		Recorder: polycarbonate, glass 10% (UL94-V0) Sensor : ABS resin, PVC resin, brass			
Dimensions		Recorder: (W)150x(H)155x(D)186mm (protuberance not included) Sensor : (W)80x(H)264x(D)110mm, cable 10m			
Weight		Recorder: approx. 1.0 kg Sensor : approx. 1.5 kg			
Accessories		CD-ROM for utility x 1, tweezer x 1, water supply bottle x 1, water reservoir x 1, stand x 1, protective cover x 1, wick x 20, banding band x 1, power cord (100VAC) x 1, fixture for panel x 2, waterproof packing for panel x 1			

## **WARRANTY POLICY**

### Warranty

Our products are warranted to be free from defects in materials and workmanship for a period of one year from date of delivery. If repair or adjustment is necessary and has not been the result of abuse or misuse within the one-year-period, please return the units on - Freight Prepaid – basis and correction of the defect will be made without charges. We alone will determine if the product problem is due to deviations or customer misuse.

Out-of-warranty products will be repaired on charge basis.

### Warranty during transportation

The warranty during transportation only applies to the products that we arrange the shipment. The case that the products had been purchased in domestic and were sent to overseas by the purchaser is out of warranty.

### Return of items

Authorization must be obtained from us before returning items for any reason. When applying for authorization, please include data regarding the reasons the items are to be returned.

Please note that we reserve the right to make improvements in design, construction and appearance of our products without notice.