



VA & VIP Series

Valve + Actuator, Pneumatic Coaxial Valves



The VA and VIP Series combine a pneumatic actuator and valve into one body, eliminating packing glands, actuators and mounting kits. There are no exposed moving parts, eliminating pinch points and increasing operator safety. Since the actuator is part of the valve, costs are greatly reduced when compared to standard actuated valves.

Operating life has been tested to well over 1,000,000 cycles, the balanced design reduces friction and wear. The stroke is linear and parallel to the flow reducing the force to close or open the valve dramatically. The internal waterway design was designed for optimum flow characteristics.

FEATURES

- Integrated pneumatic actuator
- NAMUR solenoid mounting pad
- Compact assembly
- Fast valve actuation
- High CV (flow coefficient)
- High cycle-life
- Competitive price
- Complete accessory equipment

MATERIALS

Body: Nickel Plated Brass

End Connections: NPT or G (BSPP)

Piston: Ni Plated Brass (EN 12164 CW614N)

Main Seat: NBR, EPDM, or Viton®

O-ring & Lip Seals: NBR, EPDM, or Viton®

[see page 4 for complete material details](#)

TYPICAL APPLICATIONS

- Air drying equipment
- Pollution control equipment
- Process control applications
- Laundry equipment
- Textile dyeing and drying
- Bottling and dispensing equipment
- Ink and paint dispensing
- Industrial compressors

SIZES & END CONNECTIONS

NPT: 3/8" to 2"

G (BSPP): 3/8" to 2"

MAXIMUM PRESSURE

29 inHg vacuum to 150 PSIG

[see Pressure/Temperature Curve](#)

TEMPERATURE RANGE

NBR: -4°F to 176°F

EPDM & Viton®: -4°F to 302°F

[see Pressure/Temperature Curve](#)

SPECIAL MODELS

- Prepared for use with Oxygen
(special request - fees apply)

C_v FACTORS

Size	C _v (Coefficient of Flow [gpm])
3/8"	3
1/2"	7.5
3/4"	12.7
1"	18.1
1 1/4"	28.9
1 1/2"	53.2
2"	67.0

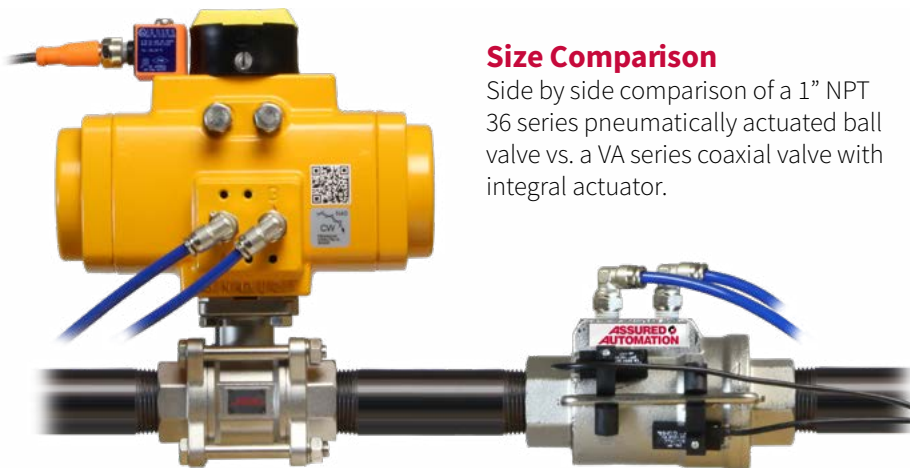

Size Comparison

Side by side comparison of a 1" NPT 36 series pneumatically actuated ball valve vs. a VA series coaxial valve with integral actuator.



VA & VIP Series



Valve + Actuator, Pneumatic Coaxial Valves

OPERATION

Spring Return - Normally Closed (Air to Open, Spring to Close)

Closed

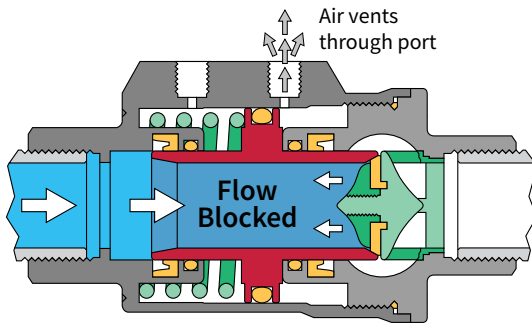

Spring pushes piston onto seat to form a seal and prevent flow

Open

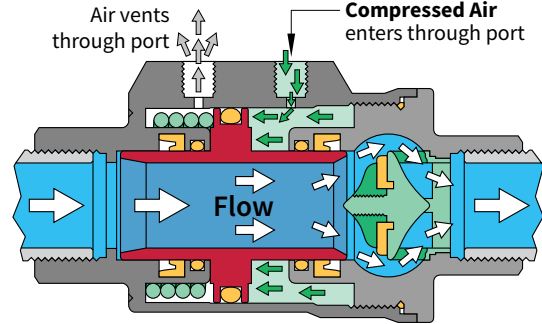

Compressed Air pushes piston away from seat to allow flow to pass

Spring Return - Normally Open (Spring to Open, Air to Close)

Open

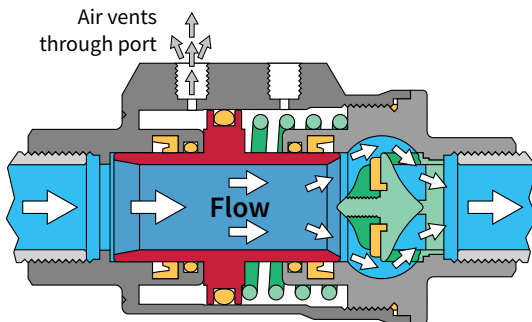

Spring pushes piston away from seat to allow flow to pass

Closed

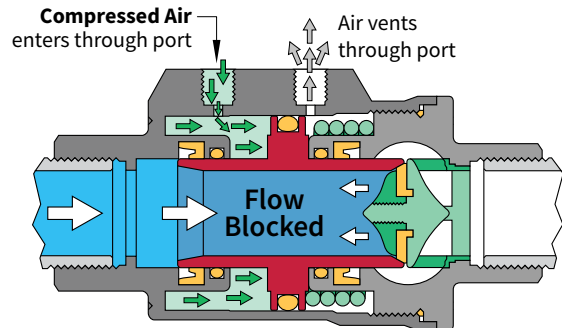

Compressed Air pushes piston away from seat to allow flow to pass

Double Acting (Air to Open, Air to Close)

Closed

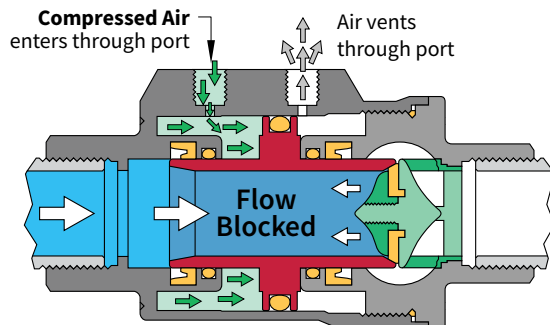

Compressed Air pushes piston onto seat to form a seal and prevent flow

Open

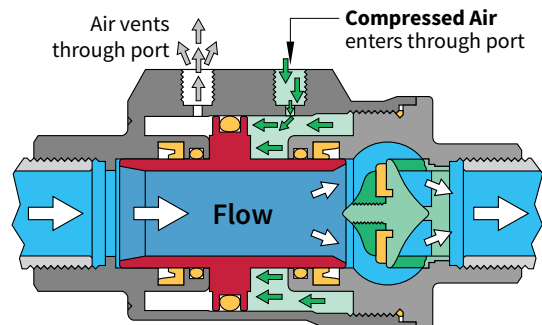

Compressed Air pushes piston away from seat to allow flow to pass



VA & VIP Series



Valve + Actuator, Pneumatic Coaxial Valves

CONSTRUCTION

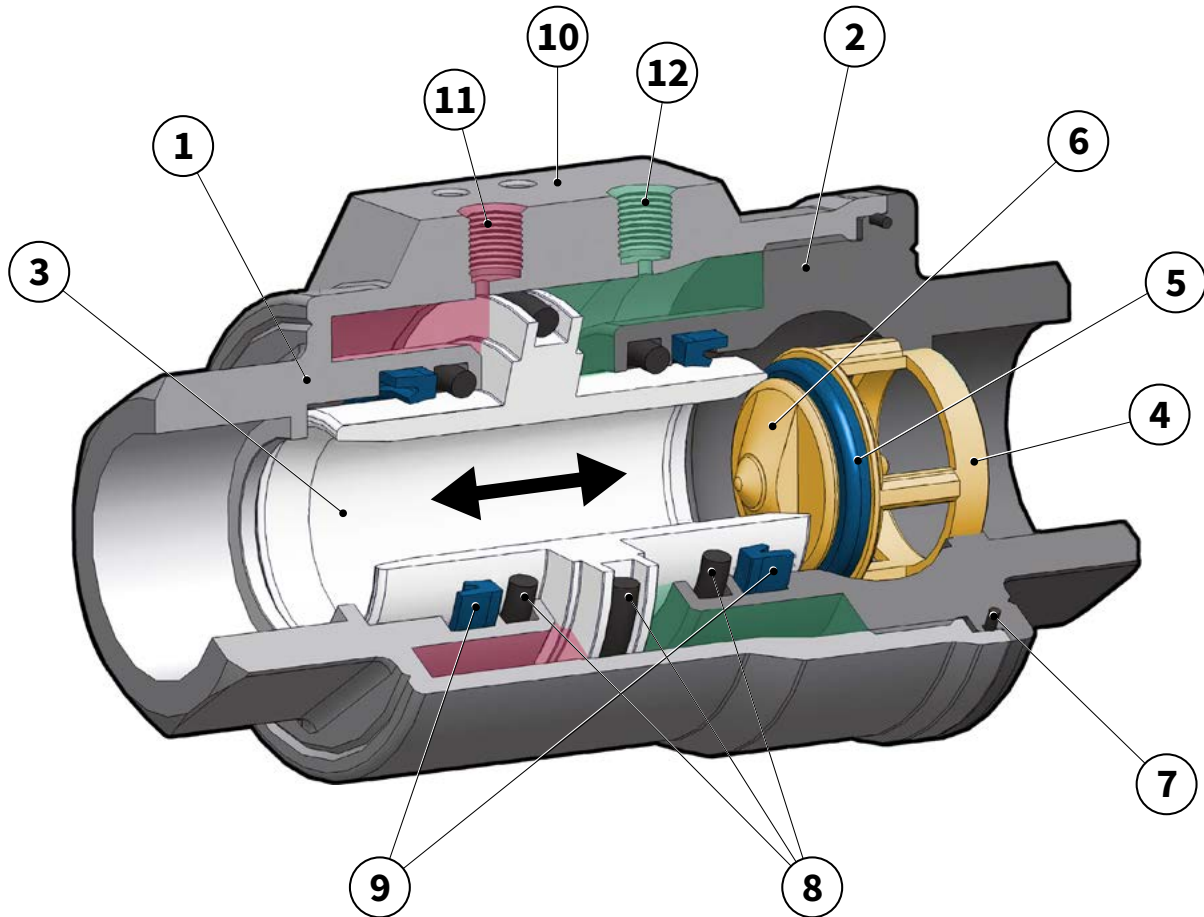

Item	Part / Feature	Description
1	Valve Body	Compact and streamline Nickel plated brass
2	End Cap	Screws into valve body to form the 2-piece valve
3	Flow Tube Piston	Slides back and forth to control flow
4	Seat Support	Holds seat in place but allows flow around
5	Seat Seal	Soft seal allows flow tube piston to seat and provide positive shutoff
6	Seat Nut	Holds seat seal onto seat support
7	Body O-ring	Seals body to prevent air leakage from valve OPEN actuator chamber
8	Piston O-rings	Provide secondary seal between flow media and actuator air chambers
9	Lip Seals	Provide primary seal between flow media and actuator air chambers
10	NAMUR Mounting Pad	Allows for simple addition of a NAMUR solenoid valve
11	Air Port (to Close)	G 1/8" port for supply air to actuator CLOSE chamber
12	Air Port (to Open)	G 1/8" port for supply air to actuator OPEN chamber



VA & VIP Series



Valve + Actuator, Pneumatic Coaxial Valves

MATERIALS

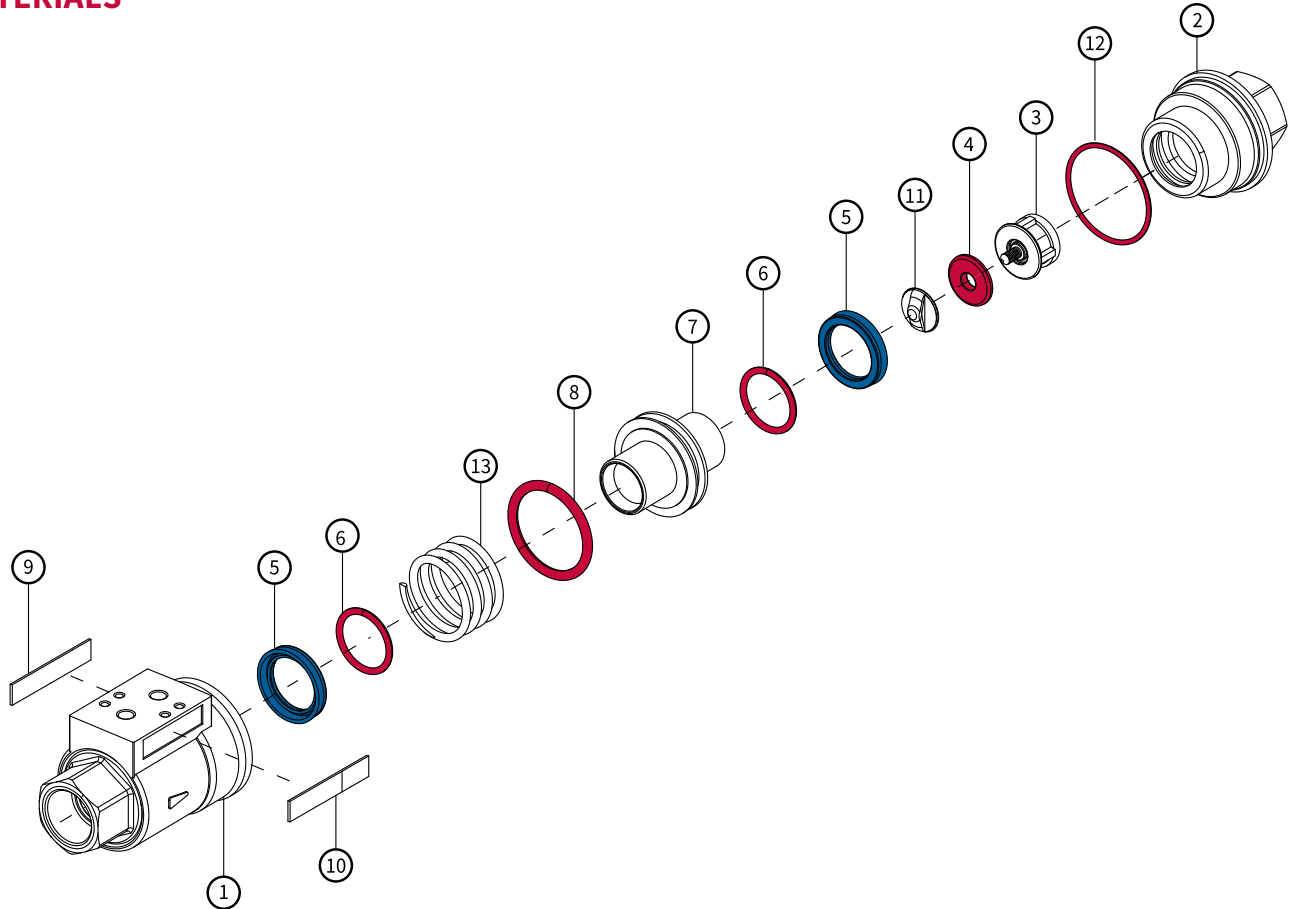

Item	Part	Material	Qty	Wetted	In Repair Kit
1	Valve Body	Nickel Plated Brass (EN 12165 CW617N)	1	X	
2	Outlet End Connection	Nickel Plated Brass (EN 12165 CW617N)	1	X	
3	Seat Support	Nickel Plated Brass (EN 12165 CW617N)	1	X	
4	Seat Seal	NBR, EPDM, or FKM	1	X	X
5	Lip Seals	NBR, EPDM, or FKM	2	X	X
6	O-ring	NBR, EPDM, or FKM	2		X
7	Flow Tube Piston	Nickel Plated Brass (EN 12165 CW617N)	1	X	
8	Piston O-ring	NBR, EPDM, or FKM	1		X
9	Technical Label Plate	Polyester	1		
10	Logo Label Plate	Polyester	1		
11	Seat Nut	Nickel Plated Brass (EN 12165 CW617N)	1	X	
12	Body O-ring	NBR, EPDM, or FKM	1		X
13	Spring	Stainless Steel	1		

REPLACEMENT PARTS

Items in **Blue** and **Red** are included in the **Seal Repair Kit**

to order a repair kit visit <https://assuredautomation.com/VA/?p=parts> or <https://assuredautomation.com/VIP/?p=parts>



VA & VIP Series



Valve + Actuator, Pneumatic Coaxial Valves

DIMENSIONS (in mm)

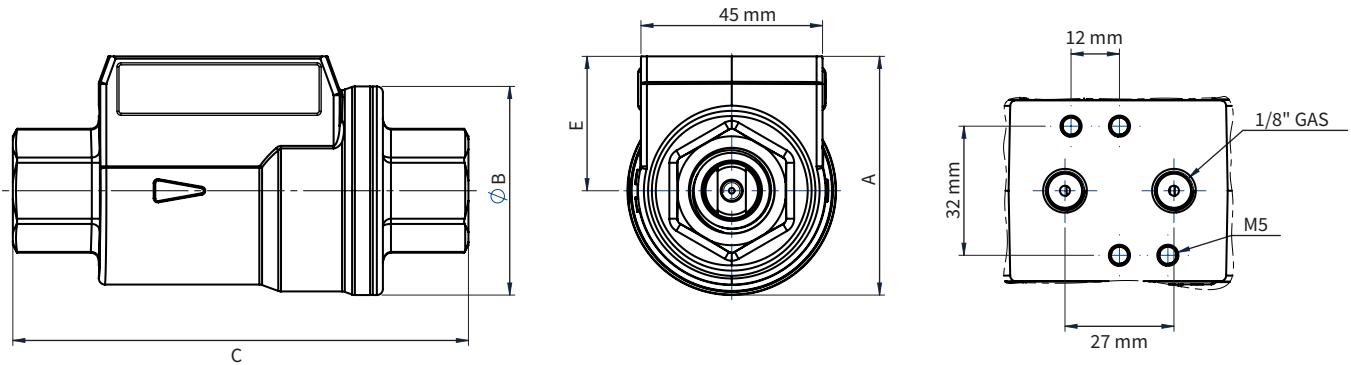

VA Series (NPT Connections)

NPT Size	A (Height)	ØB	C (Length)	E (Height from Pipe Center)	Weight (lbs.)	Stroke Speed (seconds)			
						Spring Return		Double Acting	
						Spring Stroke	Air Stroke	Air to Open	Air to Close
3/8"	54	46	92	31	1.90	0.02	0.01	0.01	0.01
1/2"	60	51.7	106	34	2.30	0.02	0.01	0.01	0.01
3/4"	70	63.5	126	39	3.70	0.03	0.02	0.02	0.02
1"	76	69	136	42	4.15	0.04	0.02	0.02	0.02
1 1/4"	92	86	154	49	7.50	0.07	0.04	0.03	0.03
1 1/2"	102	96	170	54	8.15	0.11	0.06	0.06	0.06
2"	115	109	188	60	12.75	0.13	0.07	0.07	0.07

VIP Series (G [BSPP] Connections)

G Size	A (Height)	ØB	C (Length)	E (Height from Pipe Center)	Weight (lbs.)	Stroke Speed (seconds)			
						Spring Return		Double Acting	
						Spring Stroke	Air Stroke	Air to Open	Air to Close
3/8"	54	46	98	31	1.90	0.02	0.01	0.01	0.01
1/2"	60	51.7	112	34	2.30	0.02	0.01	0.01	0.01
3/4"	70	63.5	135	39	3.70	0.03	0.02	0.02	0.02
1"	76	69	143	42	4.15	0.04	0.02	0.02	0.02
1 1/4"	92	86	165	49	7.50	0.07	0.04	0.03	0.03
1 1/2"	102	96	180	54	8.15	0.11	0.06	0.06	0.06
2"	115	109	207	60	12.75	0.13	0.07	0.07	0.07



VA & VIP Series



Valve + Actuator, Pneumatic Coaxial Valves

PRESSURE DROP

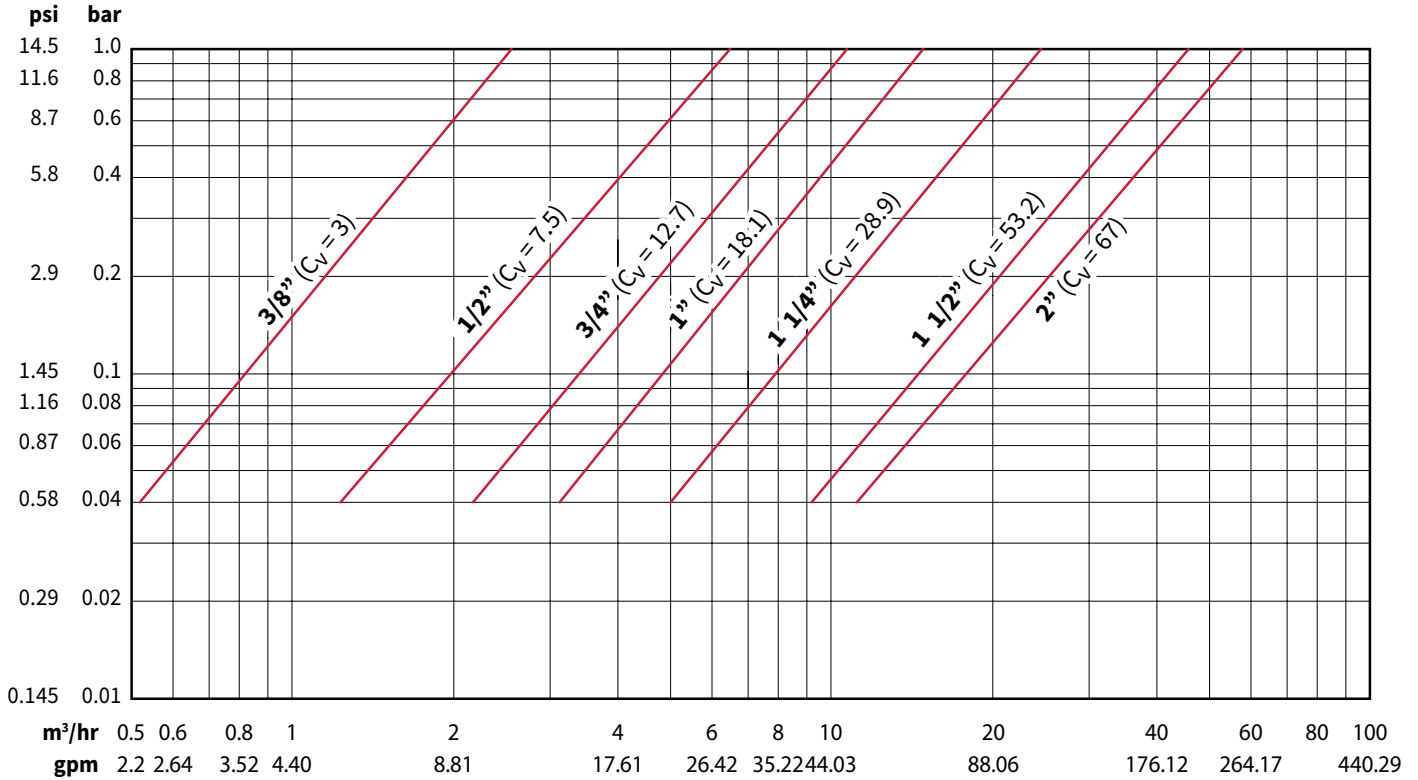

PRESSURE/TEMPERATURE

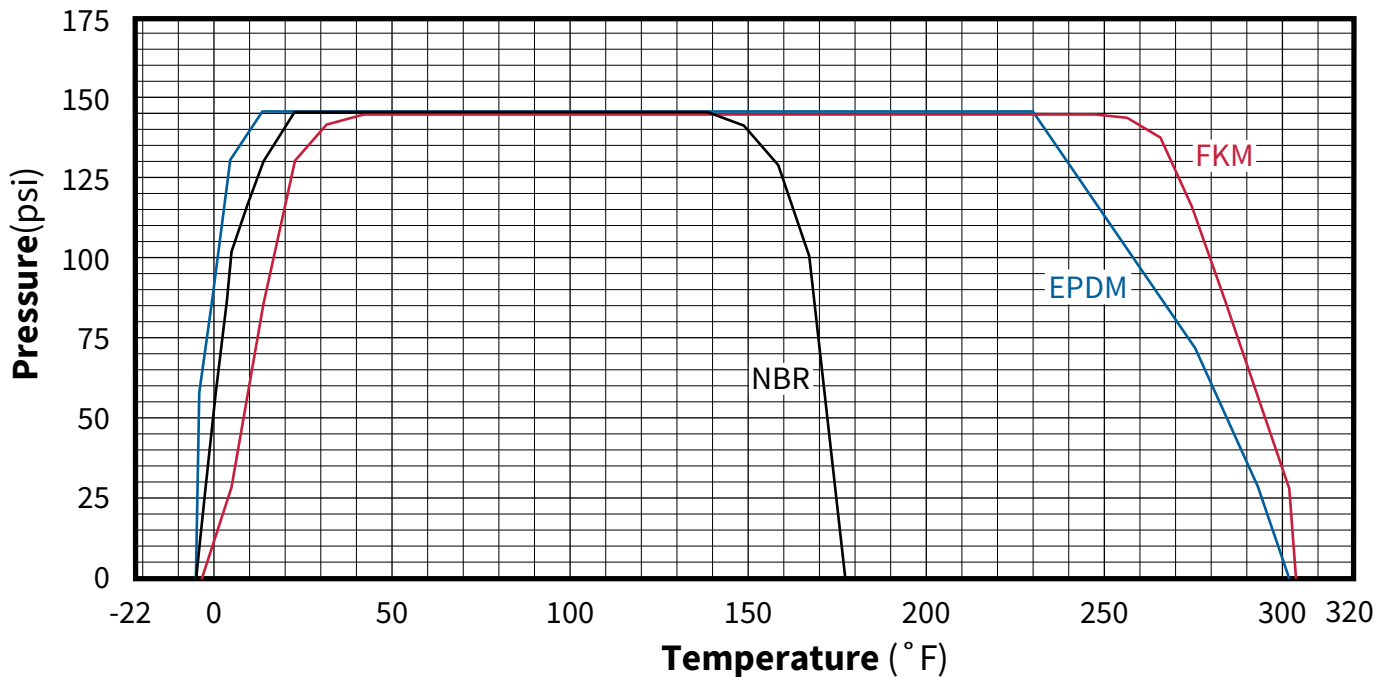



VA & VIP Series



Valve + Actuator, Pneumatic Coaxial Valves

ORDERING INFORMATION

037	VA	C	VV	C3B	G2
Size	Series	Actuation Type	Seal Material	Solenoid Valve	Limit Switch

VA (NPT connections)

Size & Connection: _____

- 037** = 3/8" NPT
- 050** = 1/2" NPT
- 075** = 3/4" NPT
- 100** = 1" NPT
- 125** = 1 1/4" NPT
- 150** = 1 1/2" NPT
- 200** = 2" NPT

Actuation Type: _____

- C** = Spring to Close (fail closed)
- O** = Spring to Open (fail open)
- D** = Double Acting (fail in place)

Seals: _____

- VV** = Viton®
- BB** = BUNA
- EE** = EPDM

ACCESSORIES

Solenoid Pilot Valve: *(omit for none)* _____

Type: _____

- C** = 3-way, 2-position (Cv = 0.08)
- E** = 3/4-way, 2-position (Cv = 0.7) - with manual override

Coil and Electrical Connector: _____

- 1** = Weatherproof (NEMA 4/4X) potted DIN 1/2" conduit
- 2** = Explosion Proof (NEMA 7) 1/2" conduit
- 3** = Weatherproof (NEMA 4/4X) DIN cord grip cable gland (PG9)
- 4** = Weatherproof (NEMA 4/4X) DIN 1/2" conduit
- 5** = Weatherproof (NEMA 4/4X) DIN cord set with 6' cable
- 6** = Weatherproof (NEMA 4/4X) DIN cord set with 15' cable

Voltage: _____

- A** = 120 VAC
- B** = 24 VDC
- C** = 220 VAC
- E** = 24 VAC
- F** = 12 VDC

Limit Switch: *(omit for none)* _____

- G2** = 2 switches, Open and Closed

C	3	B
Type	Coil & Connector	Function

Make it Easy!
Try Our Online Configurator at:
assuredautomation.com
With Instant Pricing and you can Buy Now



VA & VIP Series



Valve + Actuator, Pneumatic Coaxial Valves

ORDERING INFORMATION

VIP (G [BSPP] connections)

Actuation Type: _____

- NC** = Spring to Close (fail closed)
- NO** = Spring to Open (fail open)
- DA** = Double Acting (fail in place)

Seals: _____

- 2** = Viton®
- 1** = BUNA
- 3** = EPDM

Size & Connection: _____

- 3** = G 3/8"
- 4** = G 1/2"
- 5** = G 3/4"
- 6** = G 1"
- 7** = G 1 1/4"
- 8** = G 1 1/2"
- 9** = G 2"

ACCESSORIES

Solenoid Pilot Valve: *(omit for none)* _____

Type: _____

- C** = 3-way, 2-position (Cv = 0.08)
- E** = 3/4-way, 2-position (Cv = 0.7) - with manual override

Coil and Electrical Connector: _____

- 1** = Weatherproof (NEMA 4/4X) potted DIN 1/2" conduit
- 2** = Explosion Proof (NEMA 7) 1/2" conduit
- 3** = Weatherproof (NEMA 4/4X) DIN cord grip cable gland (PG9)
- 4** = Weatherproof (NEMA 4/4X) DIN 1/2" conduit
- 5** = Weatherproof (NEMA 4/4X) DIN cord set with 6' cable
- 6** = Weatherproof (NEMA 4/4X) DIN cord set with 15' cable

Voltage: _____

- A** = 120 VAC
- B** = 24 VDC
- C** = 220 VAC
- E** = 24 VAC
- F** = 12 VDC

Limit Switch: *(omit for none)* _____

- G2** = 2 switches, Open and Closed

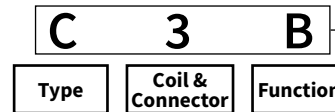

Make it Easy!
Try Our **Online Configurator** at:
assuredautomation.com
With **Instant Pricing** and you can **Buy Now**



VA & VIP Series



Valve + Actuator, Pneumatic Coaxial Valves

ACCESSORIES

Solenoid Pilot Valves

NAMUR solenoid valves for direct mount to coaxial valve (optional NP mounting plate required). Various coil and connector options are available including weatherproof, explosion proof, corded, NPT conduit, and cable gland.

3-way
for spring return models



3/4-way for
for double acting models



Limit Switches (valve position indicators)

Inductive Proximity Sensors that slip neatly into the grooves in the valve body. Integral LED indicates when switch is closed/active.

Important! use of these switches require that a magnet is installed at the factory during assembly.
They CAN NOT be installed after sale.

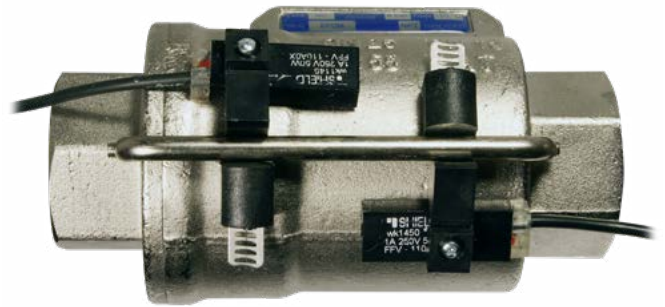

Try our **Easy to Use** Configurators at:



assured**automation.com**