

### Description

The model ESX10-TB-101-DC24V-16A extends our product group of electronic overcurrent protection devices for DC 24 V applications. At a width of only 12.5 mm it provides selective protection for all DC 24 V load circuits. This is achieved by a combination of active electronic current limitation in the event of a short circuit and overload disconnection typically from 1.15 times rated current. The ESX10-T is track-mountable and provides ease of installation for groups of devices with several circuits.

DC 24 V switch-mode power supplies are widely used in automation today. In the event of an overload, however, they turn down the output voltage which is intended to power all connected loads. So if there is a failure in a single load of the system, the supply voltage will break down also in all other load circuits. Not only does this frequently cause undefined fault conditions, but it can even lead to machine stoppages or system downtimes.

This is exactly where the ESX10-T comes in by responding to the overload conditions faster than the switch-mode power supply. The max. possible overcurrent is limited to typically 1.15 times 16 A (see table 1). This allows switching on capacitive loads of up to 20,000 µF, but a disconnection will only be effected in the event of an overload or short circuit. Visual status indication is by means of a multicoloured LED and by a single alarm. The manual ON/OFF switch on the device itself allows start-up of certain individual load circuits.



**ESX10-TB-101-DC 24 V-16 A**

As soon as the ESX10-T detects overload or short circuit in its load circuit, it blocks the load output transistor and disconnects the current flow in the faulty circuit. After remedy of the failure, the load output of the ESX10-T is re-activated by actuating the ON/OFF switch on the device.

**US patent number:** US 8,237,311 B2

### Features and benefits

- Track-mountable
- Active linear current limitation
- Capacitive loads up to 20,000 µF
- Current rating 16 A
- Approvals: UL, GL

### Your benefits

- Enhances system availability by means of a clear failure detection and stable voltage supply
- Reduces downtimes through quick failure remedy
- Simplifies planning through clear sizes and ratings
- Saves costs and time through fast as well as flexible installation including integral power distribution

### Approvals



### Compliances



### Information online

The current data sheet is available on our website:  
<http://www.e-t-a.de/qr1008/>



**Technical data (T<sub>amb</sub> = 25 °C, U<sub>B</sub> = DC 24 V)**

**Operating data**

Operating voltage U <sub>B</sub>	DC 24 V (18...26.4 V)
Current ratings I <sub>N</sub>	<b>fixed rating:</b> 16 A
Standby current I <sub>0</sub>	in ON condition: typically 18 mA
Visual status indication	<ul style="list-style-type: none"> <li>● multicoloured LED:</li> <li><b>Green:</b> <ul style="list-style-type: none"> <li>- device is ON (S1 = ON)</li> <li>- load circuit/Power-MOSFET fed through</li> </ul> </li> <li><b>Orange:</b> <ul style="list-style-type: none"> <li>- overload up to electronic disconnection</li> </ul> </li> <li><b>Red:</b> <ul style="list-style-type: none"> <li>- after disconnection due to overload or short circuit</li> <li>- short circuit up to electronic disconnection</li> <li>- at undervoltage</li> </ul> </li> <li><b>OFF:</b> <ul style="list-style-type: none"> <li>- switched off manually (S1 = OFF) or device is dead-voltage</li> </ul> </li> <li>● potential-free signal contacts F (Option)</li> <li>● ON/OFF position of the switch S1</li> </ul>

**Load circuit**

Load output	power MOSFET switching output (plus switching)
Overload and short circuit disconnection	typically 1.15 x I <sub>N</sub> with active current limitation
Trip times	see time/current characteristic typically 100 ms at short circuit typically 220 ms at overload (see table 1)
Temperature disconnection	internal temperature monitoring with electronic disconnection
operating voltage monitoring with regard to low voltage	OFF at typically U <sub>B</sub> < 14 V ON at typically U <sub>B</sub> > 17 V with automatic ON and OFF switching
Switch-on delay t <sub>Start</sub>	typically 2 ms after each ON operation, after reset and after applying of U <sub>B</sub>
Disconnection of load circuit	electronic disconnection without physical isolation
Leakage current in load circuit in the OFF condition	typically < 1 mA
Capacitive loads	up to 20,000 µF
Free-wheeling diode	external free-wheeling diode recommended for inductive load
Parallel connection of several load outputs	not allowed

**Signal output F ESX10-TB-101**

Electrical data	potential-free auxiliary change-over contact max. DC 30 V / 0.5 A min. 10 V / 10 mA
ESX10-TB-101	single signal, make contact contact open, terminal 13-14
<b>Signal delay of signal output (F)</b>	
in standard condition	typically 20 ms
in fault condition	typically 220 ms
Error	signal output is in fault condition <ul style="list-style-type: none"> <li>● when the device is switched off <ul style="list-style-type: none"> <li>- in the event of overcurrent trip</li> <li>- through lacking operating voltage U<sub>B</sub></li> <li>- at undervoltage</li> <li>- by means of the ON/OFF switch</li> </ul> </li> </ul>

**Technical data (T<sub>amb</sub> = 25 °C, U<sub>B</sub> = DC 24 V)**

**General Characteristics**

Fail-safe-element	integral fail-safe element compliant with the current rating (see table 1)
-------------------	--

**Terminals LINE+ / LOAD+ / 0V**

screw terminals	M4
max. cable cross section	
rigid and flexible	0.5 – 16 mm <sup>2</sup>
flexible with wire end ferrule w/wo plastic sleeve	0.5 – 10 mm <sup>2</sup>
multi-lead connection (2 identical cables)	
rigid / flexible	0.5 – 4 mm <sup>2</sup>
flexible with wire end ferrule without plastic sleeve	0.5 – 2.5 mm <sup>2</sup>
flexible with TWIN wire end ferrule	
with plastic sleeve	0.5 – 6 mm <sup>2</sup>
wire stripping length	10 mm
tightening torque (EN 60934)	1.5 – 1.8 Nm

**Terminals aux. contacts**

screw terminals	M3
max. cable cross section	
flexible with wire end ferrule w/wo plastic sleeve	0.25 – 2.5 mm <sup>2</sup>
wire stripping length	8 mm
tightening torque (EN 60934)	0.5 – 0.6 Nm

**Housing material moulded**

**Mounting symmetrical rail to EN 60715-35x7.5**

Ambient temperature	-25...+60 °C <sup>1)</sup> (without condensation, cf. EN 60204-1) <sup>1)</sup> Ambient temperature range can be different for the individual approvals.
---------------------	---

**Storage temperature -40...+70 °C**

Humidity	96 hrs / 95 % RH 40 °C to IEC 60068-2-78-Test Cab climate class 3K3 to EN 60721
----------	---

**Vibration 3 g test to IEC 60068-2-6, test Fc**

Protection class	housing IP20 EN 60529 terminals IP20 EN 60529
------------------	--

EMC requirements (EMC directive, CE logo)	emission: EN 61000-6-3 susceptibility: EN 61000-6-2
---	--

Insulation co-ordination (IEC 60934)	0.5 kV / pollution degree 2 reinforced insulation in operating area
--------------------------------------	--

Dielectric strength	max. DC 30 V (load circuit)
---------------------	-----------------------------

Insulation resistance (OFF condition)	n/a, only electronic disconnection
---------------------------------------	------------------------------------

Approvals (ESX10-TA / -TB)	CE logo to 2014/30/EU UL 2367, File # E306740 Solid State Overcurrent Protectors UL 508, File # E322549 "Industrial Control Equipment"
----------------------------	---

Dimensions (w x h x d)	12.5 x 80 x 83 mm (tolerances to DIN ISO 286 part 1 IT13)
------------------------	---

Mass	approx. 65 g
------	--------------

**Order numbering code**

<b>Type No.</b>	
ESX10 Electronic Circuit Protector, with current limitation	
<b>Mounting</b>	
TB	rail mounting, with signal contact and hole for signal busbars
<b>Version</b>	
1	without physical isolation
<b>Signal input</b>	
0	without signal input
<b>Signal output</b>	
1	signal make contact
<b>Operating voltage</b>	
DC 24 V	voltage rating DC 24 V
<b>Current rating</b>	
16 A	
ESX10 - TB - 1 0 1 - DC 24 V - 16 A ordering example	

Description of signal output (ESX10-T) see schematic diagram.

**Please note**



- The user has to ensure that the cable cross section of the load circuit in question complies with the current rating of the ESX10-T used.
- In addition special precautions have to be taken in the system or machinery to exclude automatic re-start (e.g. by using a safety PLC) (cf. Machinery Directive 2006/42/EG und EN 60204-1, Safety of Machinery). In the event of a failure (short circuit/overload) the load circuit will be disconnected electronically by the ESX10-T.

**Approvals ESX10-TB-...DC 24 V-16 A**

Authority	Standard	File certificate no.	Voltage ratings	Current ratings
UL	UL 2367	E306740	DC 24 V	0.5 A...16 A
UL	UL 121201 (Class I, Division 2, Groups A, B, C, D)	E320024	DC 24 V	0.5 A...16 A
UL	UL 508 CSA C22.2 No.14	E322549	DC 24 V	0.5 A...16 A
DNV GL	CG-0339 (classes: temperature, vibration: B*); humidity, EMC: A)	TAE000025Y	DC 24 V	0.5 A...16 A

\*) with busbars or jumpers: A

**Information on UL and CSA approval**

-  ESX10-TB-...-16A  
UL2367  
Solid State Overcurrent Protectors  
UL File E306740
- UL 121201  
UL File # E320024
-  UL 508  
Auxiliary Devices - Industrial Control Equipment  
UL File # E322549  
Operating Temperature Code T4

- This equipment is suitable for use in Class I, Division 2, Groups A, B, C and D or non-hazardous locations only. T4A / 0 °C to 50 °C

**WARNING – EXPLOSION HAZARD**

- Do not disconnect equipment unless power has been removed or the area is known to be non-hazardous.

This device is OPEN type equipment that must be used within a suitable end-use system enclosure, the interior of which is accessible only through the use of a tool. The suitability of the enclosure is subject to investigation by the local Authority Having Jurisdiction at the time of installation.

Wiring to or from this device, which enters or leaves the system enclosure, must utilize wiring methods suitable for Class I, Division 2 Hazardous Locations, as appropriate for the installation.

**Table 1: Voltage drop, current limitation, trip times, fail-safe element, max. load current**

Current rating $I_N$	typical voltage drop $U_{ON}$ at $I_N$	active current limitation typically	trip time $I_{SC}$ typically <sup>1)</sup>	trip time $I_{OL}$ typically <sup>2)</sup>	Fail-safe element	Max. load current at 100 % ON duty		
						$T_{AMB} = 40\text{ °C}$	$T_{AMB} = 50\text{ °C}$	$T_{AMB} = 60\text{ °C}$
16 A	150 mV	$1.15 \times I_N$	100 ms	220 ms	20 A	16 A	14 A	12 A

Note: When mounted side-by-side without convection, the devices should carry max. 80 % of their rated load continuously (100 % ON duty).

- 1) short circuit
- 2) overload

**Terminal wiring diagram ESX10-TB-101-DC24V-16 A**

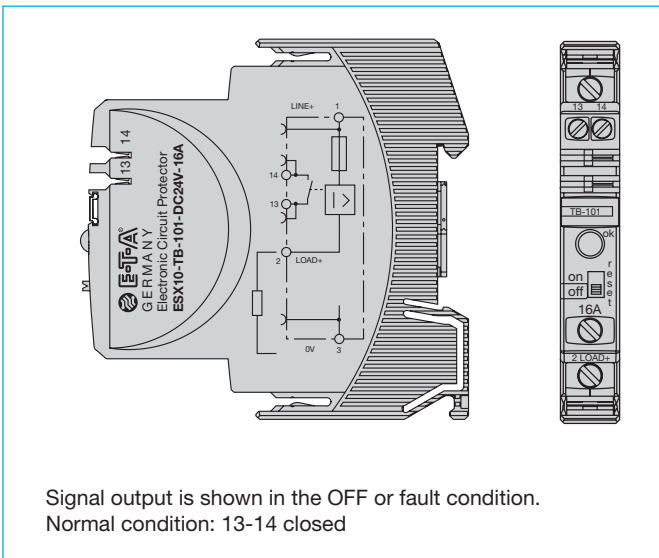

**Connection and operation elements ESX10-Tx**

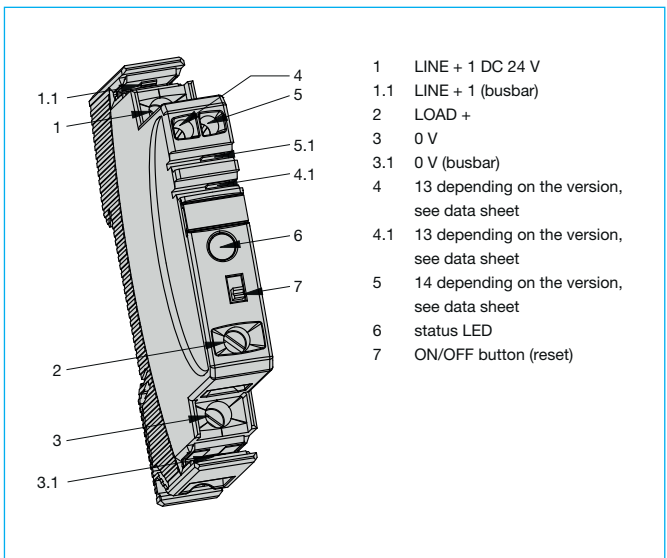

**Dimensions ESX10-TB**

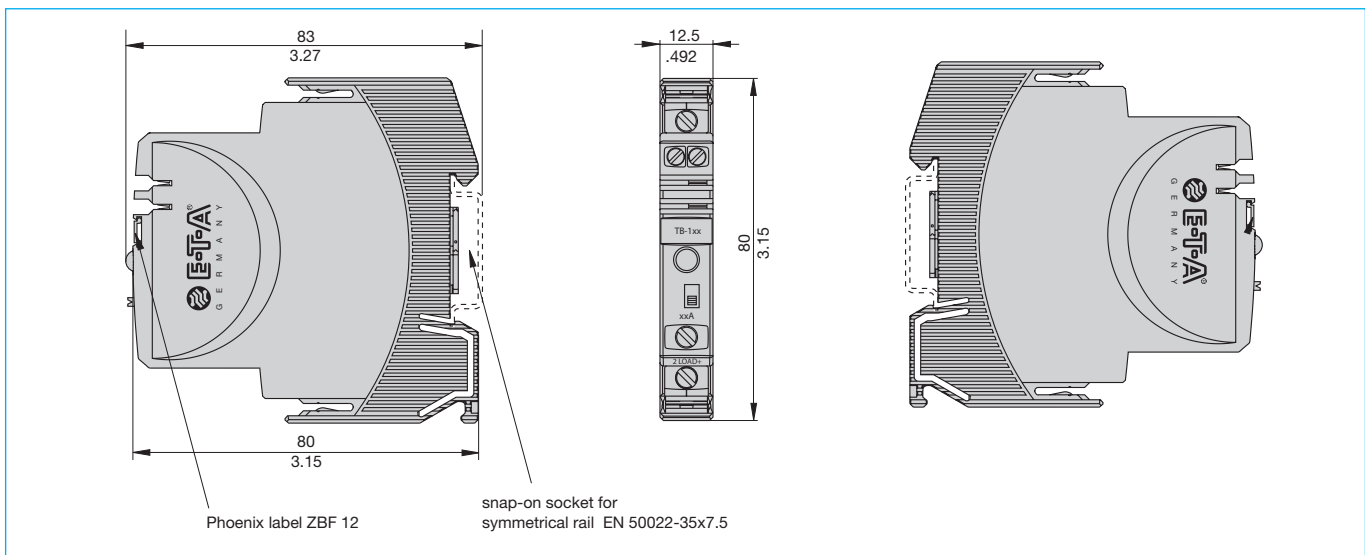

**Typical time/current characteristic**  
 ( $T_{amb} = 25\text{ }^{\circ}\text{C}$ ,  $U_B = \text{DC } 24\text{ V}$ )

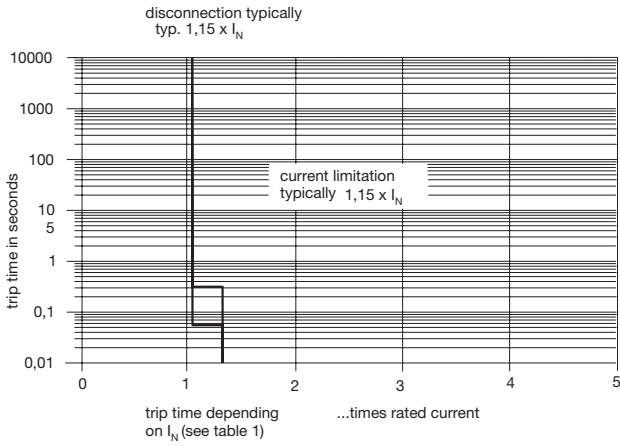

- Electronic disconnection and/or current limitation begins at typically 1.15 times  $I_N$ . **This means: under all overload conditions (independent of power supply and load circuit resistance) typically 1.15 times rated current is applied..**
- Without the current limitation getting into effect at typically  $1.15 \times I_N$  there would be a much higher overcurrent in the event of an overload or short circuit.

**ESX10-TB signal output (connection diagram)**

**ESX10-T signal inputs / outputs (schematic diagrams)**  
 Auxiliary contacts are shown in OFF or error condition

**ESX10-TB-101**  
 with signal output F  
 (single signal, N/O)

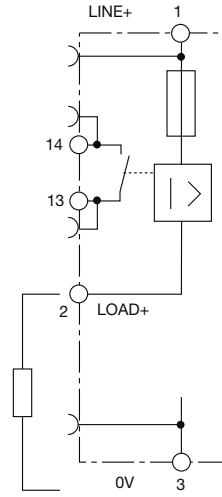

operating condition: 13-14 closed  
 fault condition: 13-14 open

## Mounting examples for ESX10-TB-101

The ESX10-T features an integral power distribution system.

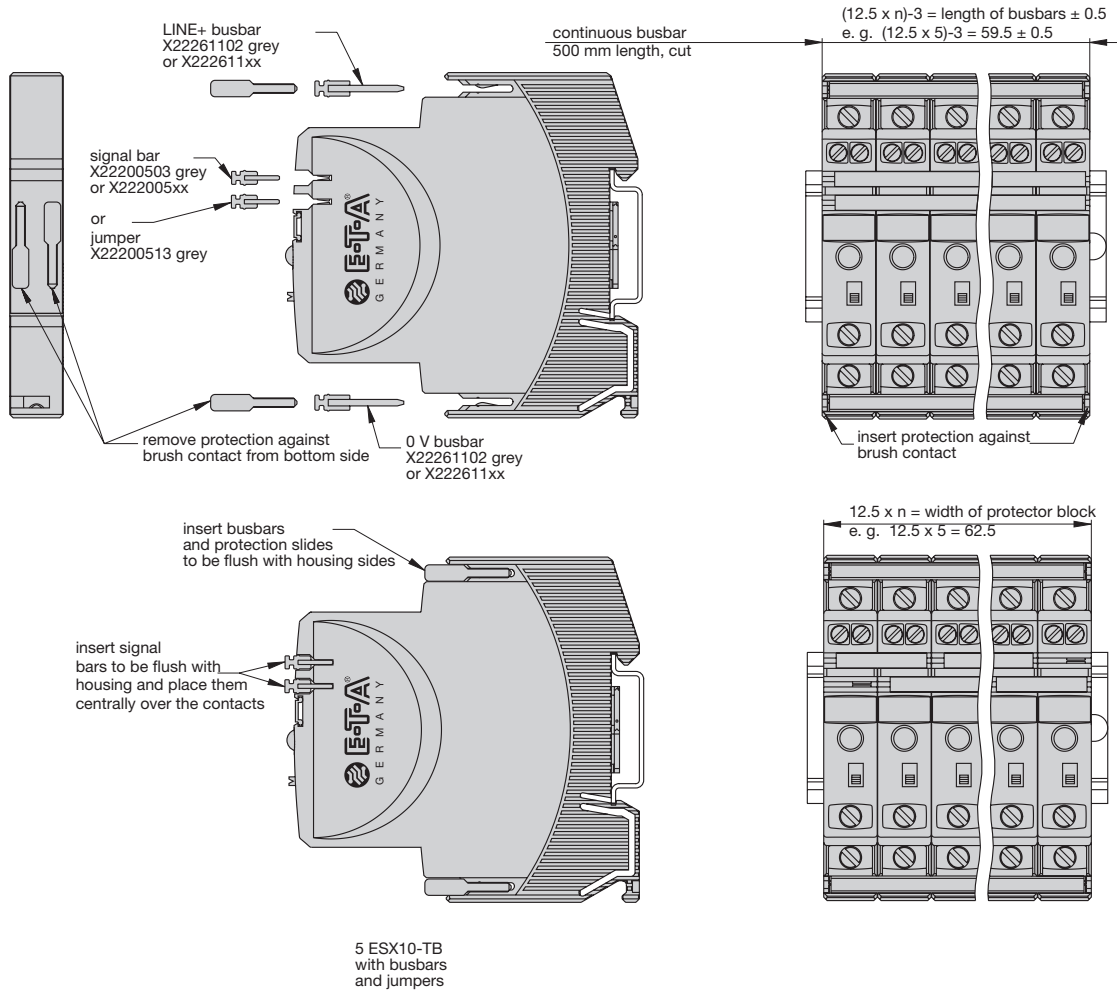

### Mounting procedure:

Before wiring insert busbars into protector block.  
Max. 10 insertion/removal cycles for busbars.

### Recommendation:

After 10 units the busbars and signal busbars should be interrupted and receive a new entry live

### Table of lengths for busbars

(X 222 611 02 / X 222 005 03 or cut off, see accessories)

No. of units	2	3	4	5	6	7	8	9	10
Length of busbar [mm] $\pm 0.5$ mm	22	34.5	47	59.5	72	84.5	97	109.5	122

## Description

The ESX10-T has an integral power distribution system. The following wirings can be carried out with different plug-in type busbars:

- LINE +(DC 24 V)
- 0 V
- **Important:** The electronic devices ESX10-T require a 0 V connection.
- Auxiliary contacts

## Accessories

### Busbars for LINE and 0 V

ampacity with one input  $I_{max}$  50 A  
(Recommendation: central supply)  
ampacity with two inputs  $I_{max}$  63 A  
grey insulation, length: 500 mm  
**X 222 611 02**

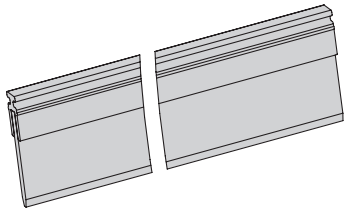

### Busbars for LINE and 0 V

grey insulation  
max. 10 plug-in cycles allowed

**X 222 611 22** (double block ESX10-T), length: 22 mm  
**X 222 611 34** (block of 3 ESX10-Ts), length: 34.5 mm  
**X 222 611 47** (block of 4 ESX10-Ts), length: 47 mm  
**X 222 611 59** (block of 5 ESX10-Ts), length: 59.5 mm  
Packaging unit: 10 pcs

**X 222 611 72** (block of 6 ESX10-Ts), length: 72 mm  
**X 222 611 97** (block of 8 ESX10-Ts), length: 97 mm  
**X 222 611 12** (block of 10 ESX10-Ts), length: 122 mm  
Packaging unit: 4 pcs

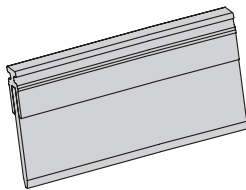

### Signal busbars for aux. contacts and reset inputs

suitable for signal busbars ESX10-TB-...  
ampacity with one input  $I_{max}$  1 A  
with aux. contacts connected in series  $I_{max}$  0.5 A  
grey insulation, length: 500 mm  
**X 222 005 03**

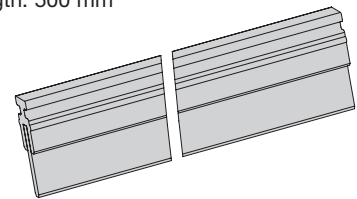

### Busbars for auxiliary contacts

suitable for signal busbars ESX10-TB-...  
grey insulation, length: 21 mm  
**X 222 005 13**  
Packaging unit: 10 pcs

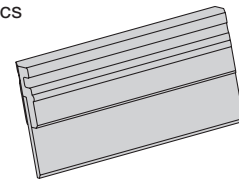

### Insulated wire bridge (for aux. contact)

optional as jumper for ESX10-TB-101...  
for group signalling  
(series connection of make contacts 13 - 14)  
**X 223 108 01**  
Packaging unit: 10 pcs

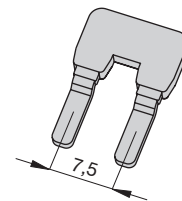

### Connector bus link -K10

suitable for auxiliary contacts (series connection)  
**X 210 589 02** (1.5 mm<sup>2</sup>, brown),

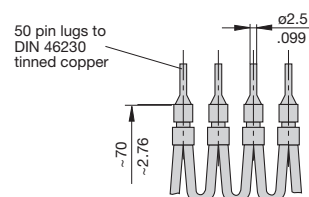

## Wiring diagrams, application examples ESX10-T

### Connection diagrams and application examples ESX10-T...

Signal contacts are shown in OFF or fault condition.

#### ESX10-TA-100

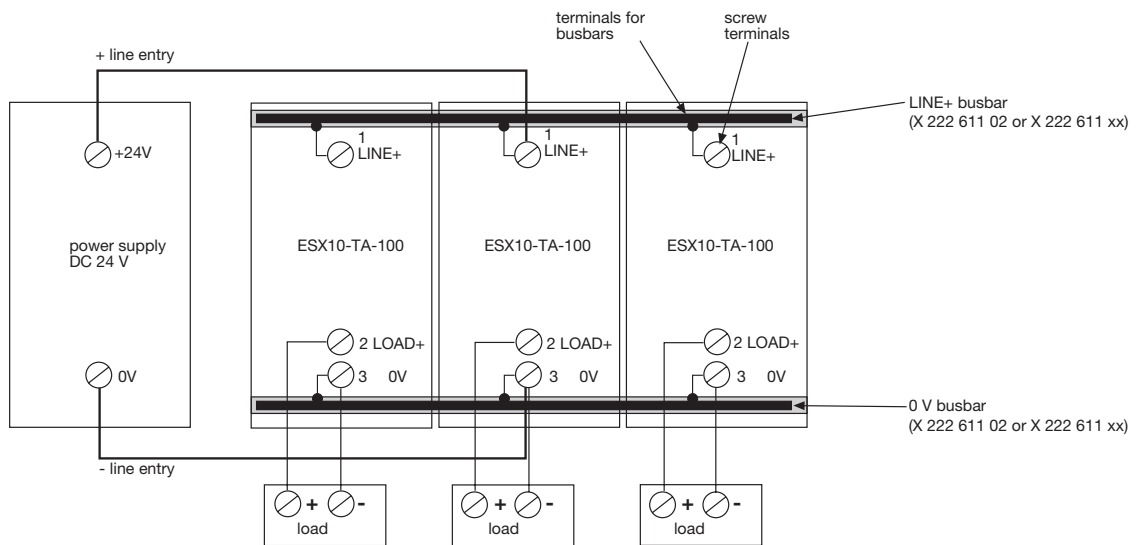

## Wiring diagrams, application examples ESX10-T

### Applications examples: line entry DC 24 V with protection of signal circuit and direct connection of loads

Auxiliary contacts are shown on the OFF of fault condition

#### ESX10-TB-101

Group signalisation (series connection)

Type ESX10-TA-100-DC24V-0.5A can be used as a supply module including protection of auxiliary circuit

Optional: passive supply module AD-TX-EM01 (without protection)

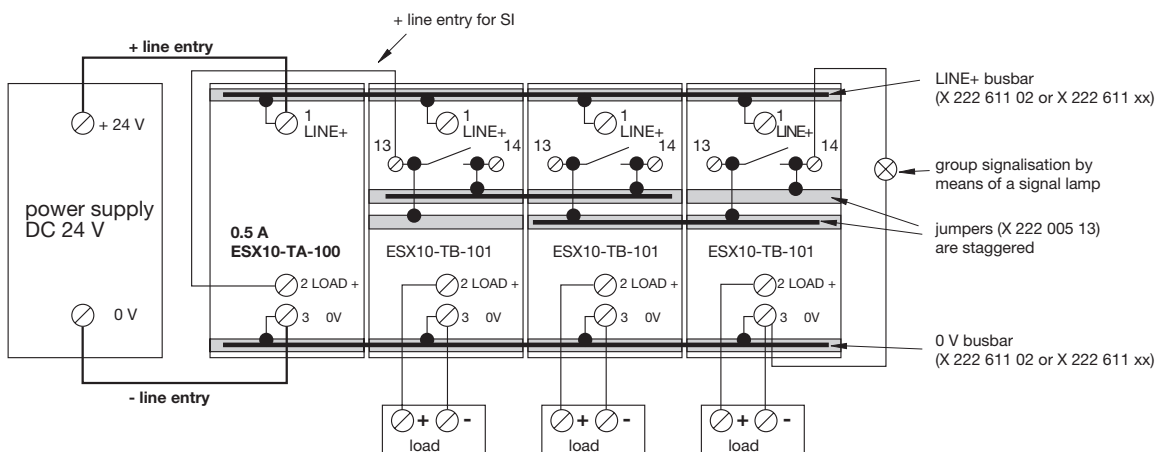



## Accessories

### Passive supply module for LINE+ and 0 V (without protection)

Ampacity

Max. cable cross section (see ESX10-T)

$I_{\max}$  50 A

#### AD-TX-EM01

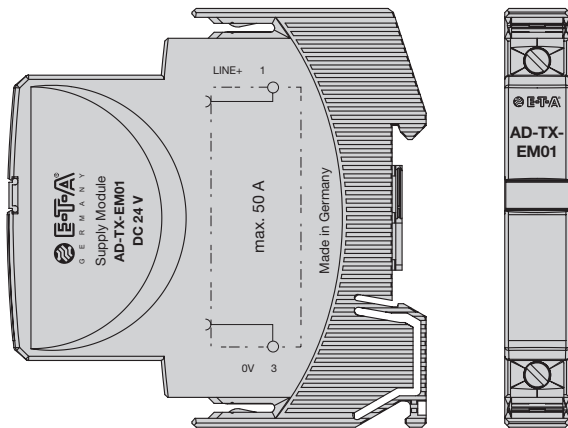

All dimensions without tolerances are for reference only. In the interest of improved design, performance and cost effectiveness, the right to make changes in these specifications without notice is reserved. Product markings may not be exactly as the ordering codes. Errors and omissions excepted.