

# AUTROL®

Doc.No.: C3100-E05A

HART  
COMMUNICATION PROTOCOL



## Smart Pressure Transmitter

for Differential / Gauge / Absolute Pressure Measurement

MODEL

# APT3100



Duon System Co.,Ltd.

# APT3100



Standard



SST Housing

## Description of Product

The APT3100 Smart Pressure Transmitter is a micro processor-based high performance transmitter, which has flexible pressure calibration and output, automatic compensation of ambient temperature and process variable, configuration of various parameters, communication with HART protocol. The application is very various, as measuring liquid, gas or steam flow as well as pressure and liquid level by application method. All data of sensor is to be input, modified and stored in EEPROM.

## Function

- » Flexible Sensor Input : DP, GP, AP, HP
- » Various Output : 4~20mA, Digital Signals
- » Setting Various Parameters : Zero/Span, Trim, Unit, Fail-mode, etc.
- » Self Diagnostic Function : Sensor, Memory A/D Converter, Power, etc
- » Digital Communication with HART protocol
- » Explosion-proof Approval & Intrinsic Safety Approval : ATEX, FM, FMCanada, GOST, KOSHA, KTL, etc.
- » Marine Certificate: ABS, LR, BR, DNV

## Features

- » **Superior Performance**
  - High Reference Accuracy:  $\pm 0.075\%$  of Calibrated Span (The option:  $\pm 0.04\%$  of Calibrated Span)
  - for range 2  
 $\pm 0.25\%$  of Span for  $0.1URL \leq \text{Span} \leq URL$   
 $\pm [0.24 + (0.008 \times (URL/\text{span}))]\%$  of Span for  $0.05URL \leq \text{Span} < 0.1URL$
  - for range 3  
 $\pm 0.075\%$  of Span for  $0.1URL \leq \text{Span} \leq URL$   
 $\pm [0.025 + (0.005 \times (URL/\text{span}))]\%$  of Span for  $0.02URL \leq \text{Span} < 0.1URL$
  - for ranges 4 to 0  
 $\pm 0.075\%$  of Span for  $0.1URL \leq \text{Span} \leq URL$   
 $\pm [0.025 + (0.005 \times (URL/\text{span}))]\%$  of Span for  $0.01URL \leq \text{Span} \leq 0.1URL$
  - Long-Term Stability (0.125% URL for 3year)
  - High Rangeability (100 : 1)(for the range 4-0)
- » **Flexibility**
  - Data Configuration with HART Configurator
  - Zero Point Adjustment
- » **Reliability**
  - Continuous Self-Diagnostic Function
  - Automatic Ambient Temperature Compensation
  - Fail-mode Process Function
  - EEPROM Write Protection
  - CE EMC Conformity Standards (EN50081-2, EN50082-2)

- Transfer Function
- Self-Compensation
- » **Self-Diagnosis and Others**
  - CPU & Analog Module Fault Detection
  - Communication Error
  - Fail-mode Handling
  - LCD Indication
  - Temperature Measurement of Sensor Module

## Function

- » **Range and Sensor Limits**
  - Refer to Table 1.
- » **Zero and Span Adjustment Limits**
  - Zero and span values can be set anywhere within the range limits stated in Table 1.(Page 9)  
Span must be greater than or equal to the minimum span stated in Table 1.(Page 9)
- » **Output (Analog Current and Digital Data)**
  - LCD Display & ENG Mode
  - Two wire 4~20mA user-configurable for linear or square root output, digital process value superimposed on 4~20mA signal, available to any host that conforms to the HART protocol
- » **Power Supply & Load Requirement**
  - External power supply required.
  - \* 250 ohm load - 17.5 Vdc
  - \* up to a 550 ohm load - 24 Vdc  
Max. Loop Resistance =  $(E - 12) / 0.022$   
(E = Power Supply Voltage)
  - Voltage Range : 12 to 45 Vdc
  - Voltage Rating : 24 Vdc  $\pm 30\%$
  - Loop Load  
0 ~ 1500 ohm - Operation  
250 ~ 550 ohm - HART Communications

## Transmitter Description

ATP3100 Pressure transmitter can be easily configured from any host that support the HART protocol.

- » **Basic Setup**
  - Operational Parameters.
  - 4~20mA Points (Zero/Span)
  - Engineering Units
  - Damping Time : 0.25 ~ 60 sec
  - Tag : 8 alphanumeric characters
  - Descriptor : 16 characters
  - Message : 32 characters.
  - Date : day/month/year
- » **Calibration and Trimming**
  - Lower/Upper Range (zero/span)
  - Sensor Zero Trimming
  - Zero Point Adjustment
  - DAC Output Trimming

- » **EMC Conformity Standards**
  - EMI (Emission) - EN50081-2:1993
  - EMS (Immunity) - EN50082-2:1995
- » **Failure Mode**
  - Fail High : Current  $\geq 21.1$  mA
  - Fail Low : Current  $\leq 3.78$  mA
- » **Storage Temperature**
  - -40°C to 85°C (without condensing)
- » **Process Temperature Limits**
  - (Range codes and approval codes may effect limits)
  - -40°C to 120°C (-104 to 248°F)

## Functional Block Diagram

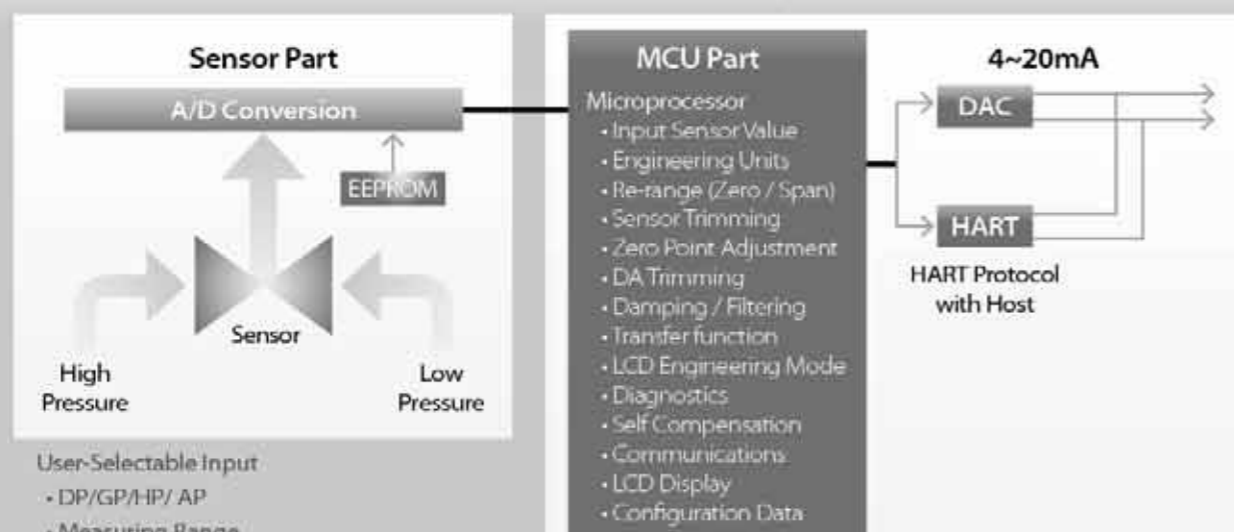

\* Subject to change without notice



## Function

- » Isolation
  - Input/output isolated to 500Vrms (707Vdc)

### » Working Pressure Limits (silicone oil)

- Model D & G 0~13.79 MPa - # 3~8
- Model G 0~40.00 MPa - # 9
- 0~75.00 MPa - # 0
- Model H 0~31.02 MPa - # 4~7
- Model A 0~525 KPa - # 4
- 0~3000 KPa - # 5
- 0~5250 KPa - # 6

### » Hydrostatic Test Pressure

- Model D 3000 psi (20.7 MPa)
- Model H 6750 psi (46.5 MPa)
- Model G 2000 psi (13.8 MPa) - # 3~8
- 11600 psi (80 MPa) - # 9
- 11600 psi (80 MPa) - # 0
- Model A 101.5 psi (700 KPa) - # 4
- 580 psi (4000 KPa) - # 5
- 1015 psi (7000 KPa) - # 6

### » Burst Pressure

- Model D, G, H 68.9 MPa
- G8~9 50 MPa
- G0 80 MPa
- Model A4 1050 KPa
- A5 4000 KPa
- A6 7000 KPa

### » 5 Digit LCD

- Express all pressure unit and flow unit.
- Use 5 digit.
- Select decimal place (0 to 4)

### » User define unit function



### » Change main parameter by Button

- Change Unit
- Change Upper range value
- Change Lower range value
- Change the Damping Second
- Select the Decimal Place
- Zero Trim
- Zero Adjustment



Moving within Menu : Zero  
 Moving to below Menu : Span  
 Moving Top Menu : Zero+Span

### » Button Manu tree

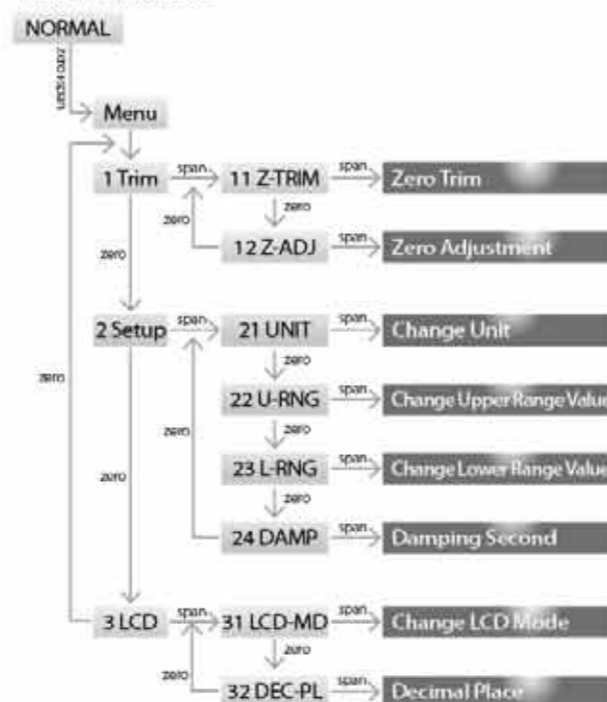

## Physical Specifications

### » Wetted Materials

- Isolating Diaphragms 316L SST, Monel, Tantalum, HAST-C
- Drain/Vent Valves 316 SST, HAST-C
- Flanges and Adapters 316 SST(ASTMCF8M), HAST-C
- O-ring Vitor, PTFE

### » Non-wetted materials

- Fill Fluid Silicone oil or Inert fill
- Bolts 304 SST
- Electronics Housing Aluminum or 316L SST (Option) Flameproof and Waterproof (IP67)
- Cover O-ring Buna-N
- Paint Epoxy-Polyester or Polyuret
- Mounting Bracket 304SST with U-bolt (304SST) for 2-inch pipe
- Nameplate 304 SST

### » Electrical connections

- 1/2-14 NPT conduit with M4 Screw Terminals

### » Process Connections

- 1/4-18 NPT on 2.126 inch (54.0 mm) centers on flanges for Standard
- 1/2-14 NPT on Process Adapter (option)
- \* Refer to drawing in the last page

### » Weight

- 3.9 kg ( Standard - excluding options )
- 5.35kg (SST Housing- excluding options)

## Exploded drawing of APT3100

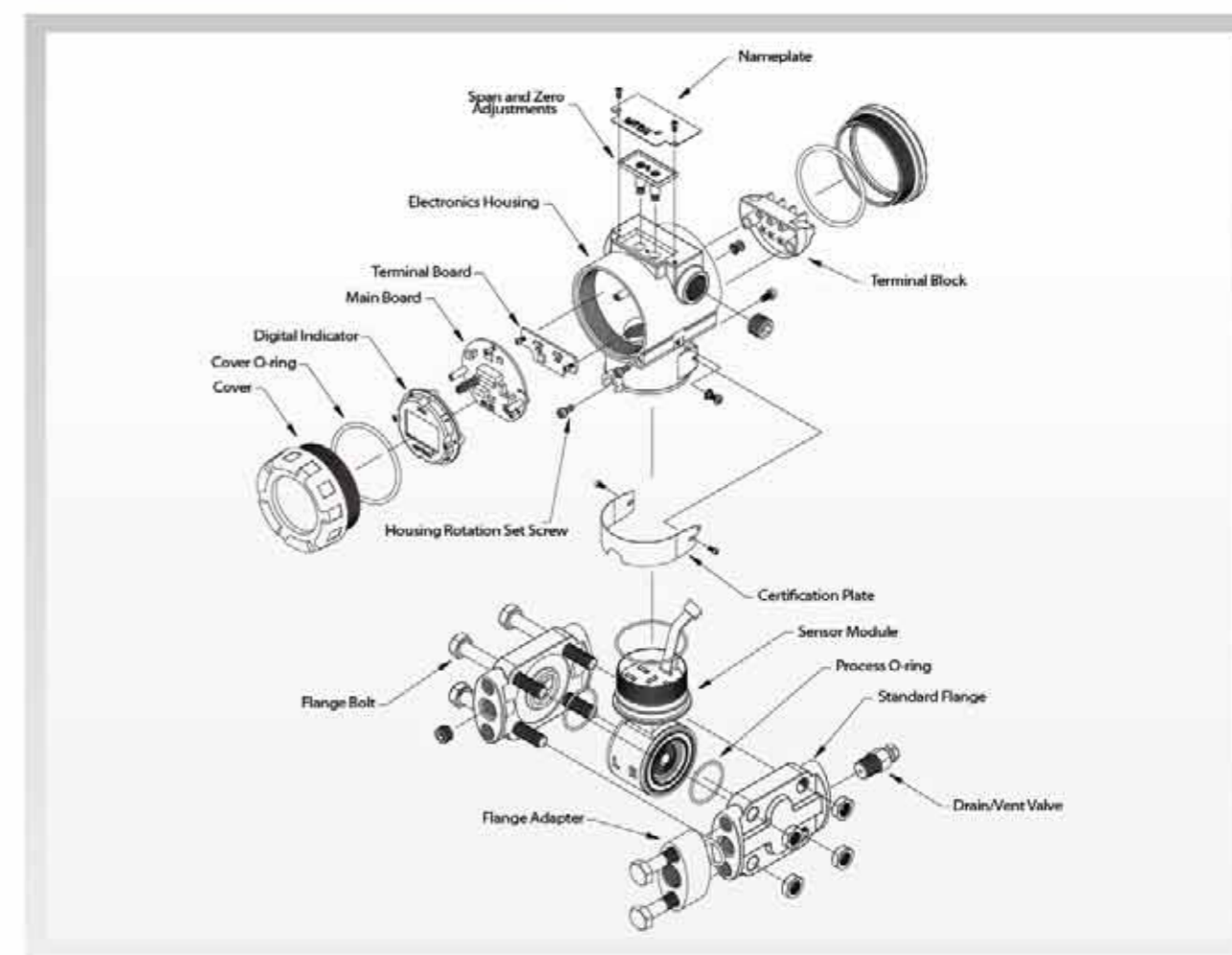



### Hazardous Location Certifications (option)

» KOSHA Approvals K1 Code :

\* KOSHA: Korea Occupational Safety & Health Agency  
 Flameproof for Class I, Zone 1 : Ex d II CT6, IP67  
 Ambient Temperature : -20 to 60°C  
 Max. Process Temperature : 80°C  
 Power Supply : Max. 45 Vdc  
 Output : 4 to 20 mA + HART, Max. 22 mA

» KTL Certification K2 Code :

\* Intrinsic Safety: Ex ia IIC T6  
 Ambient Temperature : -40 to 60°C  
 Ui=30Vdc, Ii=200mA, Pi=0.9W, Ci=47nF, Li=94µH

» ATEX Approvals E1 Code :

CE 0344 II 2 G Ex d IIC T6, T5 or T4  
 Operating Temperature: -20°C ≤ Tamb ≤ +60°C  
 T6 for process ≤ 85°C; T5 for process ≤ 100°C  
 T4 ≤ 130°C  
 APT3100 ATEX Certification is according to the below standards : EN 60079-0 : 2006  
 EN 60079-1 : 2007

» FM and FM Canada Approvals F1 Code :

\* FM: Factory Mutual explosion proof  
 \* FM Canada: Canadian requirements  
 Explosion proof for Class I, Division 1  
 Groups A, B, C and D  
 Dust-ignition proof for Class II/III, Division 1,  
 Groups E, F and G  
 Nonincendive for Class I, Division 2, Groups A, B, C & D;  
 Class II, Division 2, Groups E, F & G; and Class III,  
 Division 1,  
 Enclosure: indoors and outdoors, NEMA Type 4X

# APT3100 MP Option

Easy installation regardless fluid line conditions



### Advantage

Conventionally, in the case where the pressure transmitter should be vertically installed irrespective of the orientation of the fluid inflow lines, modified flanges are required in addition to the basic flanges. As a result, the modified flanges must be additionally provided.

Multi-planar pressure transmitter has been made in an effort to solve the problems occurring in the related art, and an object of this multi planar is to provide a pressure transmitter, capable of being vertically installed without separate adaptor or various types of brackets regardless of the position of each fluid inflow line.

### Dimension

### Connection Diagram of Signal, Power, HHT for Transmitter

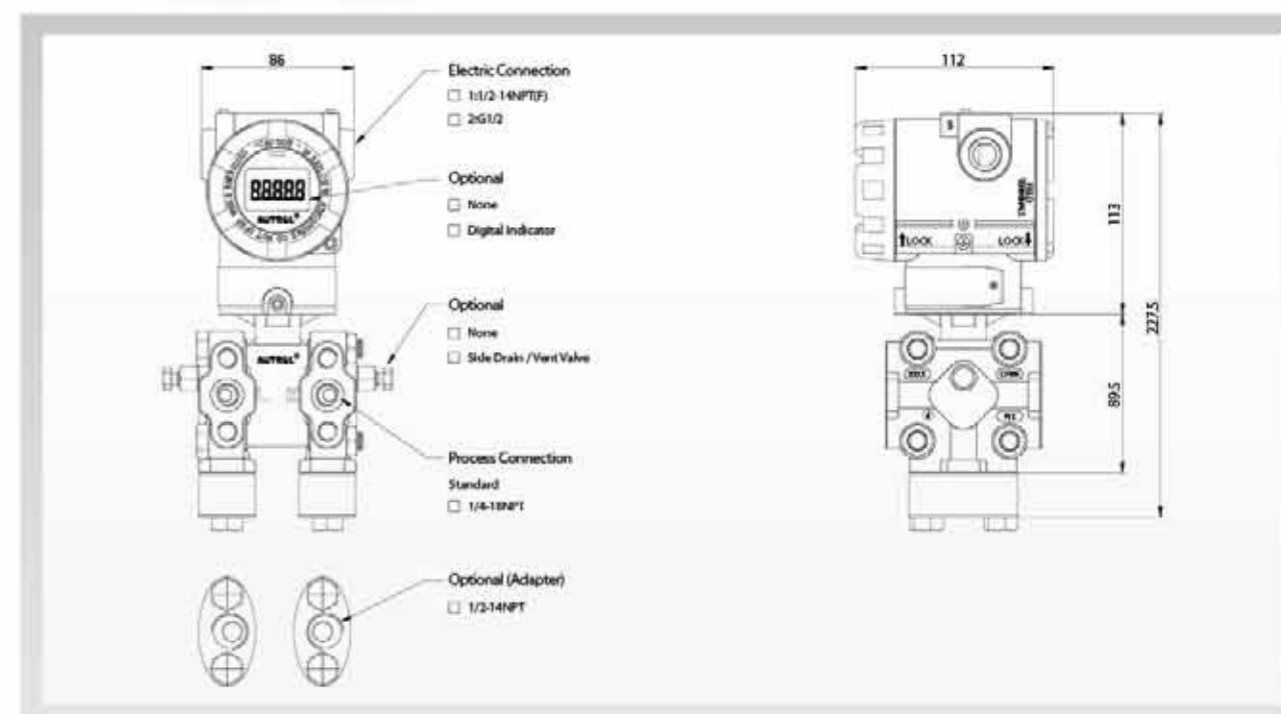
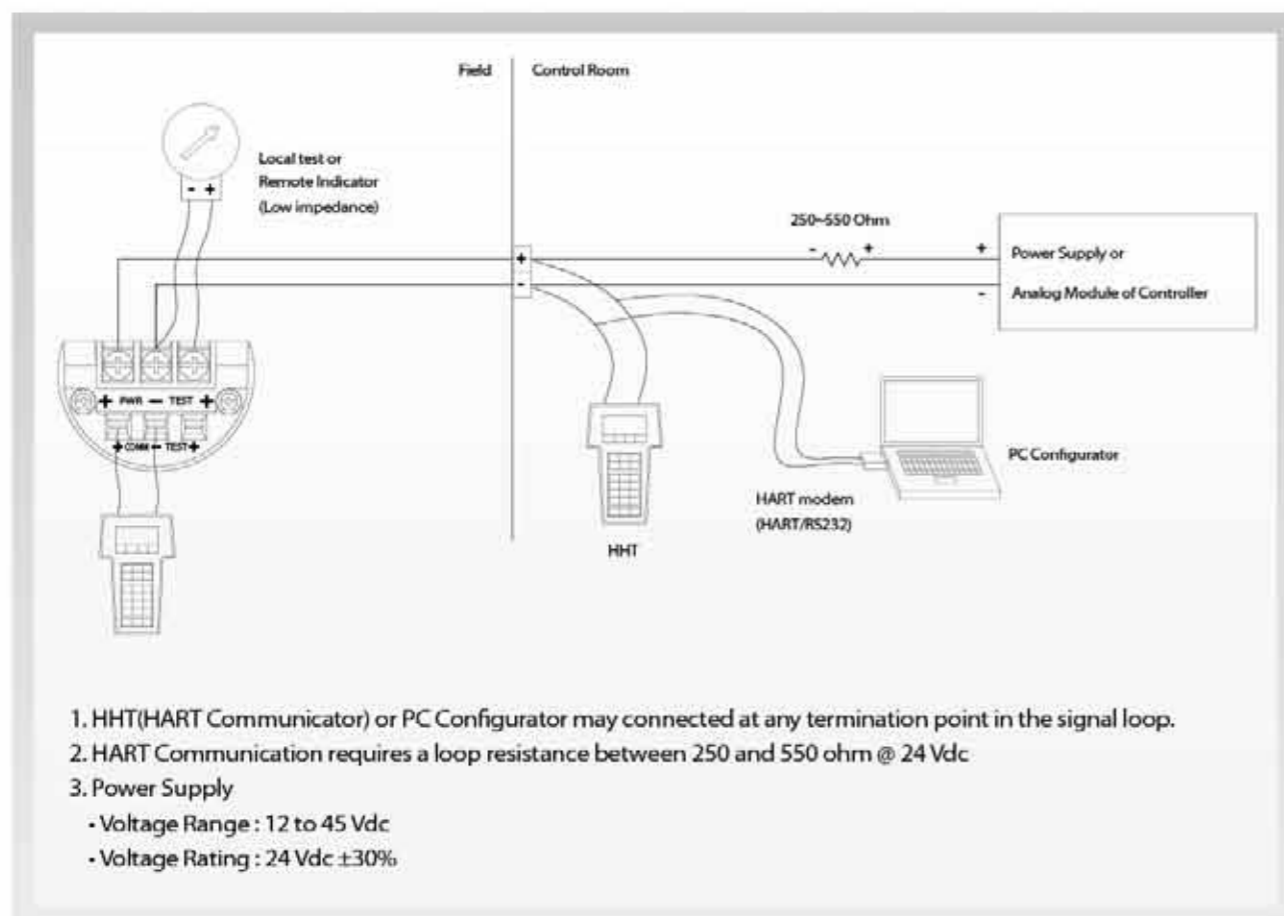



# APT3100F

## Description

APT3100F is added the totalizing function in APT3100 transmitter. So it is available to check the flow rate and total flow.

- » Measuring & Express Flow rate and Total flow
- » Pulse output by accumulation of total flow
- » APT3100F measures the flow rate by using differential pressure so it is not compensated the temperature and static pressure

## Wiring

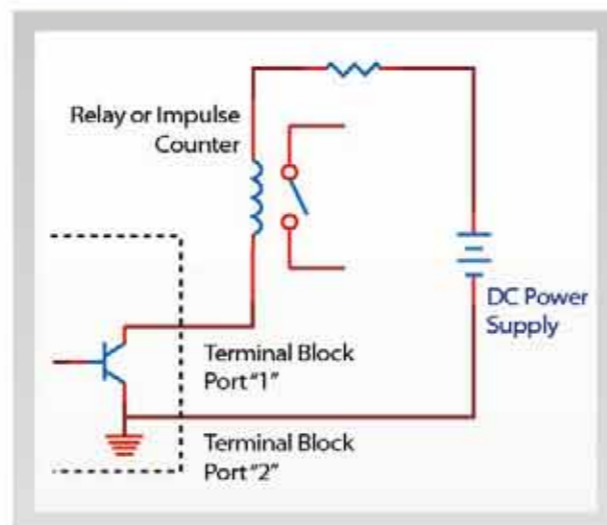

In the case of connecting with Relay or Counter.

## External Appearance

APT3100F is same shape with APT3100 but the terminal block is different.



- 1: Pulse out +
- 2: Pulse out -

## Pulse specification

- » Scaled Pulse: A Single pulse is output for a specified flow amount.
- » Pulse Width: 10ms, 50ms, 100ms selectable (Negative going pulse)
- » Duty Cycle: 49 Pulse/sec. Max.
- » Output Type: Open Collector, 30V, 500mA Max.



The picture of STT 20 (Autrol configuration program)

## General Specifications

(Rangeability : #2=20:1 / #3=50:1 / 4~0=100:1)

### 1. APT3100 Pressure Sensor Range & URL

<Table 1>

Range Code	DP / GP / HP / F					AP	
	Calibrated Span (KPa)	Upper Range (URL) (KPa)	Lower Range (LRL) (KPa)			Calibrated Span (KPa)	Range (KPa)
2	0.075 ~ 1.5	1.5	-1.5	-1.5	NA	NA	NA
3	0.15 ~ 7.5	7.5	-7.5	-7.5	NA	NA	NA
4	0.373 ~ 37.3	37.3	-37.3	-37.3	-37.3	25 ~ 250	0 ~ 250
5	1.865 ~ 186.5	186.5	-186.5	-100	-186.5	15 ~ 1500	0 ~ 1500
6	6.9 ~ 690	690	-690	-100	-690	25 ~ 2500	0 ~ 2500
7	20.68 ~ 2068	2068	-2068	-100	-2068	NA	NA
8	68.95 ~ 6895	6895	-6895	-100	NA	NA	NA
9	206.8 ~ 20680	20680	NA	-100	NA	NA	NA
0	413.7 ~ 41370	41370	NA	-100	NA	NA	NA

Range Code	KPa	Kg/cm <sup>2</sup>	bar	psi	inH <sub>2</sub> O@4°C	mmH <sub>2</sub> O@4°C	inHg@0°C
2	1.5	0.015	0.015	0.217	6	152	0.442
3	7.5	0.076	0.075	1.087	30	765	2.215
4	37.3	0.38	0.373	5.41	149	3804	11.014
5	186.5	1.902	1.865	27.049	749	19018	55.072
6	690	7.036	6.9	100.073	2773	70361	203.75
7	2068	21.088	20.68	299.93	8310	210878	610.66
8	6895	70.309	68.95	1000.009	27708	703097	2036.025
9	20680	210.876	206.8	2999.303	83105	2108781	6106.597
0	41370	421.856	413.7	6000.211	166085	4218566	12216.55

### 2. Electrical Specifications

Power Supply	12 to 45 Vdc	Output Signal	4 ~ 20 mA dc / HART
HART loop resistance	250 ~ 550 ohm	Isolation	500Vrms (707Vdc)

### 3. Performance Specifications

Reference Accuracy	± 0.075% of Span (0.1 URL ≤ Span ≤ URL) ± [0.025 + 0.005 × (URL/Span)]% of Span (0.01 URL ≤ Span < 0.1 URL)	Ambient Temperature	-40 ~ +85°C
Ambient Temp. Effect	± [0.019% URL + 0.125% Span] / 28°C	LCD Meter Ambient Temp	-30 ~ +80°C
Stability	± 0.125% URL for 36 Months	Humidity Limits	5% ~ 100% RH
Static Pressure Effects	± 0.1% of URL per 7MPa (Zero Error) ± 0.2% of Reading per 7MPa (Span Error)	Process Temperature Limits	-40°C ~ +120°C
		Power Supply Effects	± 0.005% of Span per Volt
		Mounting Position Effects	Zero Shift up to 350Pa No Span Effect

### 4. Physical Specifications

Isolating Diaphragm	316L SST	Process Connection Size	1/4 - 18 NPT
Drain & Vent Valve	316 SST	(Adapter - Option)	1/2 - 14 NPT
Flange & Adapter	316 SST	Electrical Connections	1/2 - 14 NPT with M4
O-ring	Viton, PTFE	Weight (excluding Option Items)	3.9 Kg (Standard) 5.35Kg (SST Housing)
Electronic Housing	Aluminum (Option: 316L SST)	2" Pipe Standhion Type bracket	Angle or Flat type
Bolts & Bolting Flange	304 SST	Housing Class	Waterproof (IP67), 4X



## Ordering Information

MODEL	Code	Description					
APT3100	-D	Differential Pressure Transmitter (Static Pressure 13.79 MPa / 2000psi)					
	-F	Flow Transmitter (on the principle of Differential Pressure Use and only for Head)					
	-G	Gauge Pressure Transmitter					
	-H	Differential Pressure Transmitter for High Line Pressure (Static Pressure 31.02MPa / 4500psi)					
	-A	Absolute Pressure Transmitter					
Ranges			DP/GP/HP			*AP	
		Calibrated Span Min. to Max.	Lower Range Limit		Upper Range Limit	Range- APT3100-A	
			APT3100-D	APT3100-G	APT3100-H		
	2	0.075 ~ 1.5 KPa	-1.5 KPa	-1.5 KPa	NA	1.5 KPa (6.022 inH <sub>2</sub> O)	NA
	3	0.15 ~ 7.5 KPa	-7.5 KPa	-7.5 KPa	NA	7.5 KPa (30 inH <sub>2</sub> O)	NA
	4	0.373 ~ 37.3 KPa	-37.3 KPa	-37.3 KPa	-37.3 KPa	37.3 KPa (150 inH <sub>2</sub> O)	0~250 KPa
	5	1.865 ~ 186.5 KPa	-186.5 KPa	-100KPa	-186.5 KPa	186.5 KPa (750 inH <sub>2</sub> O)	0~1500 KPa
	6	6.9 ~ 690 KPa	-690 KPa	-100KPa	-690 KPa	690 KPa (100 psi)	0~2500 KPa
	7	20.68 ~ 2068 KPa	-2068 KPa	-100KPa	-2068 KPa	2068 KPa (300 psi)	NA
	8	68.95 ~ 6895 KPa	-6895 KPa	-100KPa	NA	6895 KPa (1000 psi)	NA
9	206.8 ~ 20680 KPa	NA	-100KPa	NA	20680 KPa (3000 psi)	NA	
0	413.7 ~ 41370 KPa	NA	-100KPa	NA	41370 KPa (6000 psi)	NA	
X	Special						
Mounting Flange /Material		Body		Vent Plug		Diaphragm	
	M11	316 SST		316 SST		316L SST	
	M12	316 SST		316 SST		HAST - C	
	M13	316 SST		316 SST		Monel	
	M14	316 SST		316 SST		Tantalum	
	*M21	HAST - C		HAST - C		HAST - C	
	*M22	HAST - C		HAST - C		Monel	
*M23	HAST - C		HAST - C		Tantalum		
Hazardous Location Certifications	K0	Maker Standard (Waterproof : IP67)					
	K1	KOSHA Flameproof Approval		K2 KTL Intrinsic Safety Approval			
	E1	ATEX(KEMA) Flameproof		E2 ATEX(KEMA) Intrinsic Safety			
	F1	FM & FM Canada Explosion proof		F2 FM & FM Canada Intrinsic Safety			
Fill Fluid	1	Silicone (DC200)		2	Inert fill fluid (Halocarbon oil)		
Process Connection	S	1/4 - 18 NPT (Standard)		O	1/2 - 14 NPT Female (Adapter) X Special		
Electrical Connection	1	1/2-14NPT Epoxy-Polyester Painted Aluminum		2	G1/2 Epoxy-Polyester Painted Aluminum(Adapter) X Special		
Option	M1	LCD Indicator(5digit)					
	MP	Multi-Planar					
	LPI	Lightening Protector (Internal)		LPE Lightening Protector (External)			
	K	Oil Free Finish					
	F1	Side Vent / Drain Top					
	F2	Side Vent / Drain Bottom					
	2W	2 Way Manifold (SST) : Remote type type		2WF Flange type			
	3W	3 Way Manifold (SST) : Remote type type		3WF Flange type			
	5W	5 Way Manifold (SST) : Remote type type		5WF Flange type			
	BA	Stainless Steel Bracket (Angle type) with SST Bolts					
BF	Stainless Steel Bracket (Flat type) with SST Bolts						
ST	Stainless Steel Housing						
T	Teflon O-Ring (Wetted Part)						
X	Special						

## Installation With Mounting Bracket

### 2" Pipe Mounting Bracket Model Angle Type

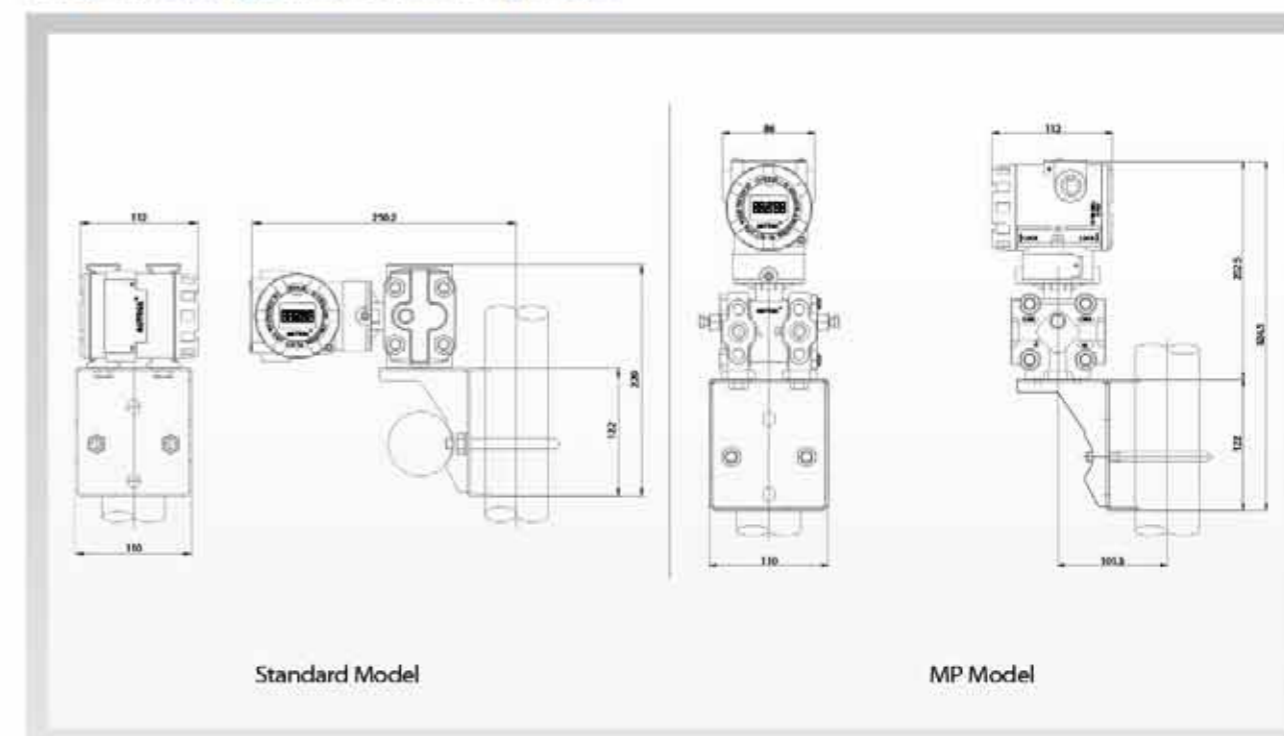

### 2" Pipe Mounting Bracket Model Flat Type

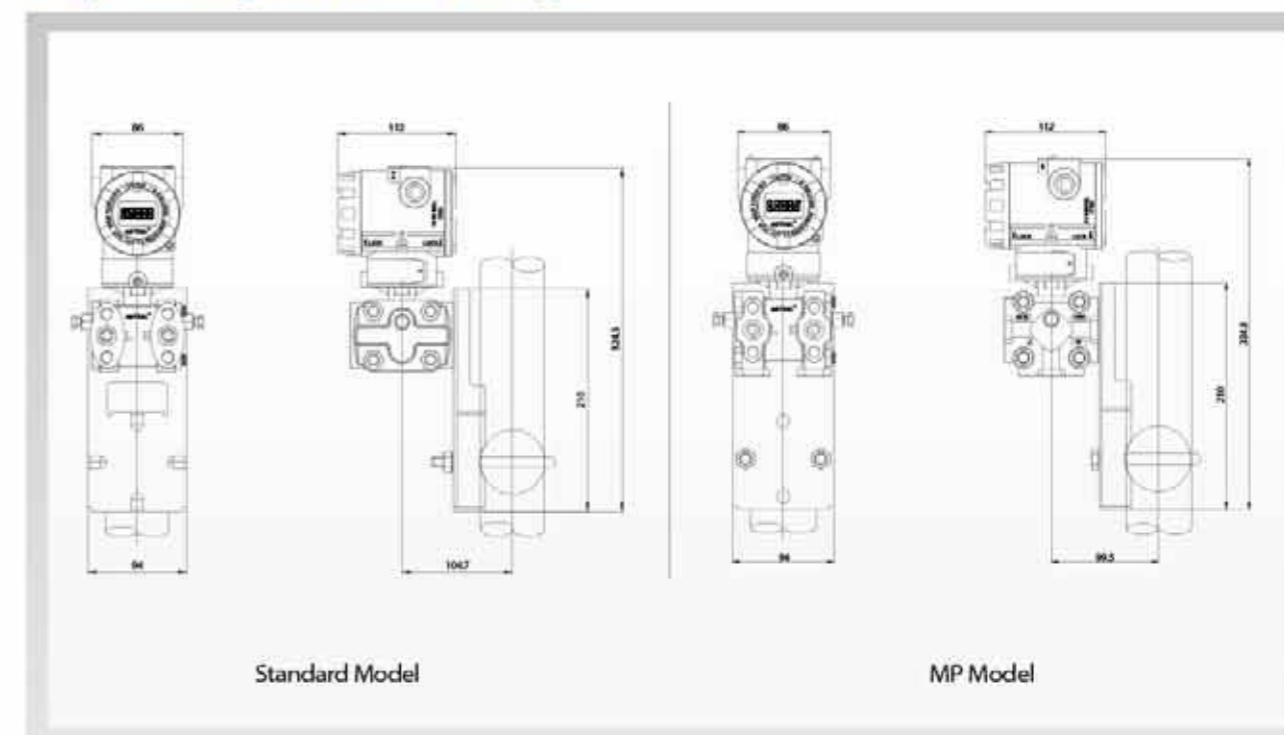

Example : APT3100-D5-M11-E1-1-S-1-M1-BA

Note 1 : Request to manufacturer for Draft Range, Absolute (small pressure and vacuum) and Items marked \*\*\* before order.

## Dimensions of Transmitter (mm)

### Standard Model

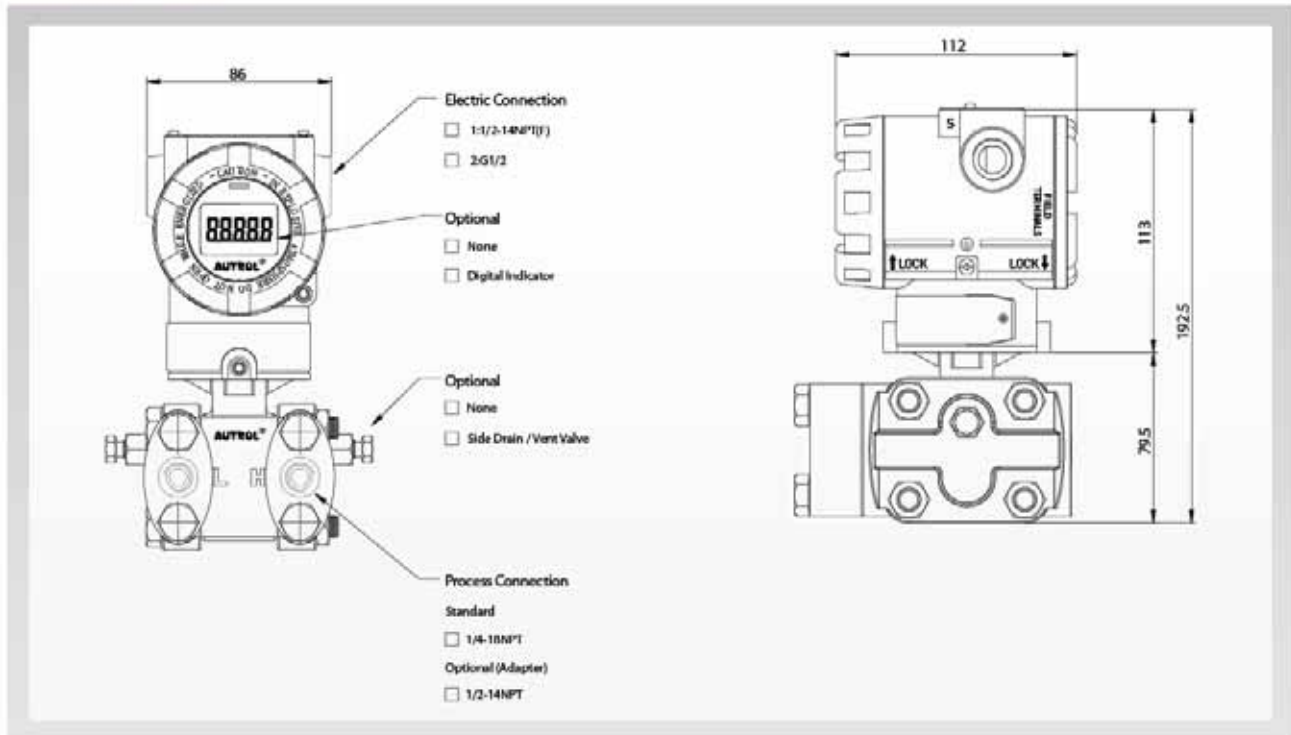

### Intrinsically safe Model

