

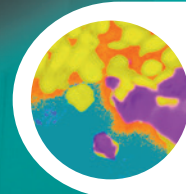

Miltenyi Biotec

# UltraMicroscope Blaze™

The automation of light sheet microscopy

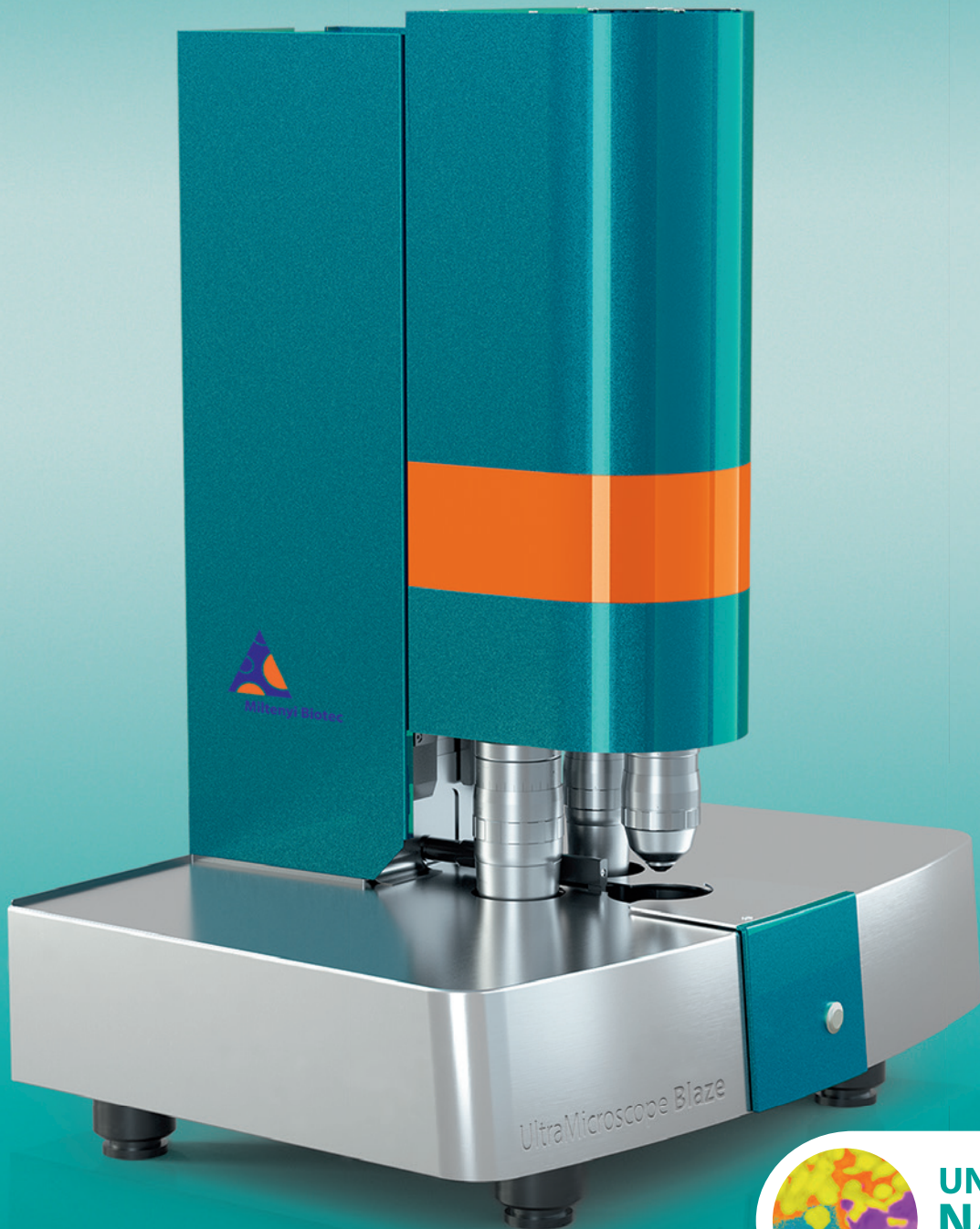

**UNDERSTAND  
NATURE'S  
COMPLEXITY**

# Light sheet imaging from a new perspective

Discover our fully automated light sheet microscope UltraMicroscope Blaze for imaging multiple or very large samples with subcellular resolution. Explore microscopy at a different level to accelerate your projects and pave the way for new insights. The combination of our pioneering UltraMicroscope technology with the latest developments in the field of light sheet optics and sample preparation guarantees best data quality.

## Easy handling based on full automation

The UltraMicroscope Blaze enables seamless switching between different objectives and magnification lenses with the click of a button while keeping images sharp with the autofocus feature. Automated movement of the sample chamber greatly facilitates sample loading and exchange.

## Image multiple samples together

Accelerate your research by imaging several different samples together. The large sample holder can either host a whole cleared mouse model or multiple samples at once, which can then be imaged sequentially and effortlessly. See the big picture without losing the subcellular details.

## Next-level light sheet imaging

Cutting-edge illumination optics guarantee homogeneous excitation, and the specially developed MI Plan objective series delivers unprecedented image quality.





# Easy handling based on full automation

The UltraMicroscope Blaze originates from a decade of experience and is designed to expedite your research projects. Our users' feedback has been the driving force to create this new member of the UltraMicroscope family.

Loading a sample into the microscope and switching between different magnifications has never been easier. Enter the fast lane with the new UltraMicroscope Blaze and pave the way for new insights.

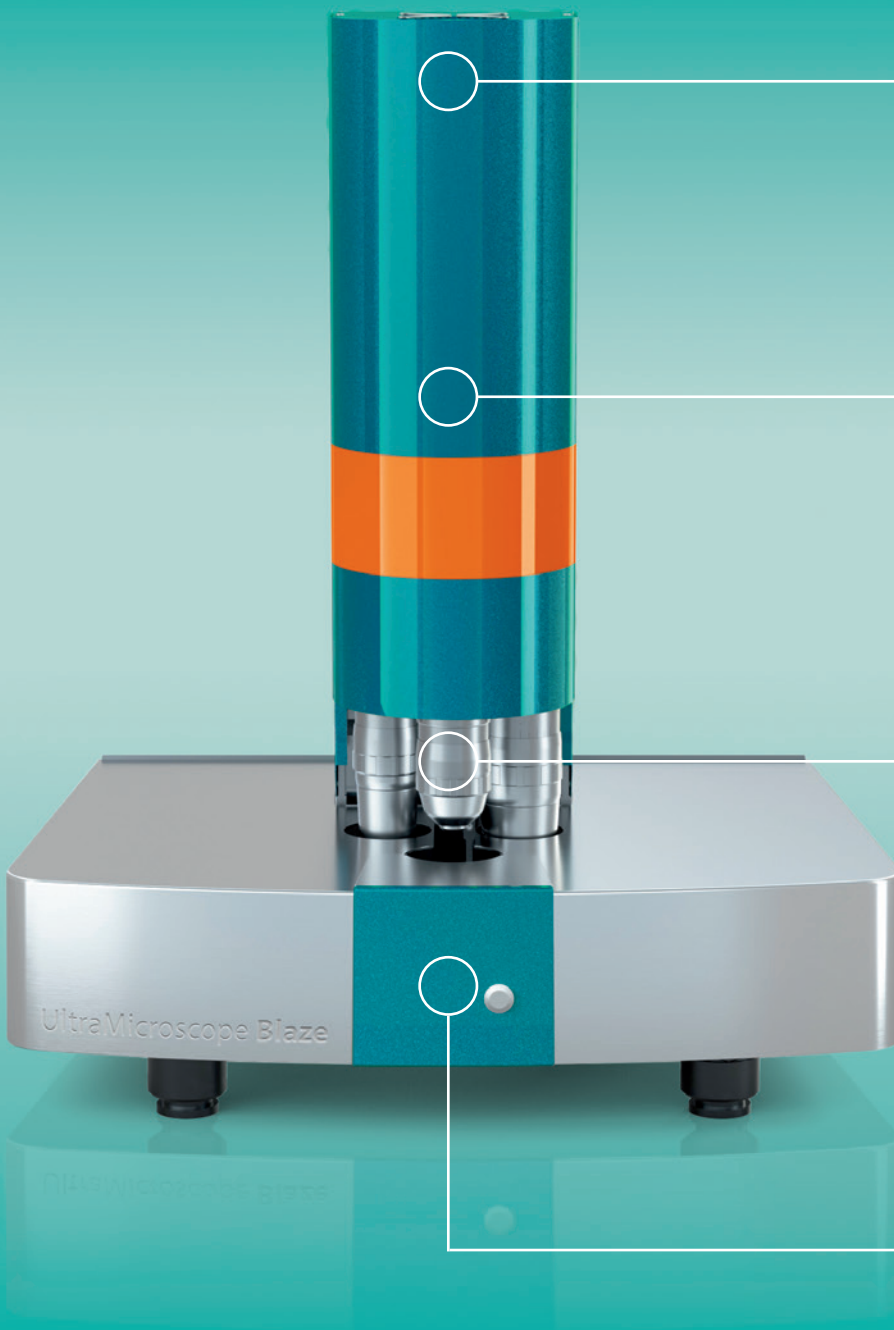

## Autofocusing

Keep your images sharp after sample and objective changes.

## Automated magnification changer

Software-controlled change of magnification from 0.6x to 2.5x.

## Motorized turret: from overview to subcellular imaging

Switch automatically between our MI Plan objective lenses.

## Automated sample release

The large sample chamber can be moved automatically allowing easy sample loading and exchange. It can host a whole cleared mouse or multiple samples that can be imaged together.

# Image multiple samples together

The new UltraMicroscope follows a simple rule: “Enable the easiest imaging of multiple or large samples for best data quality”. Now you can reduce time-consuming sample exchanges and avoid sectioning artifacts to increase your output on

high-quality data. Load all of your samples at once (fig. 1) and run a pre-set program overnight. The UltraMicroscope Blaze will do the rest and your high-quality 3D data will be ready for you the next morning.

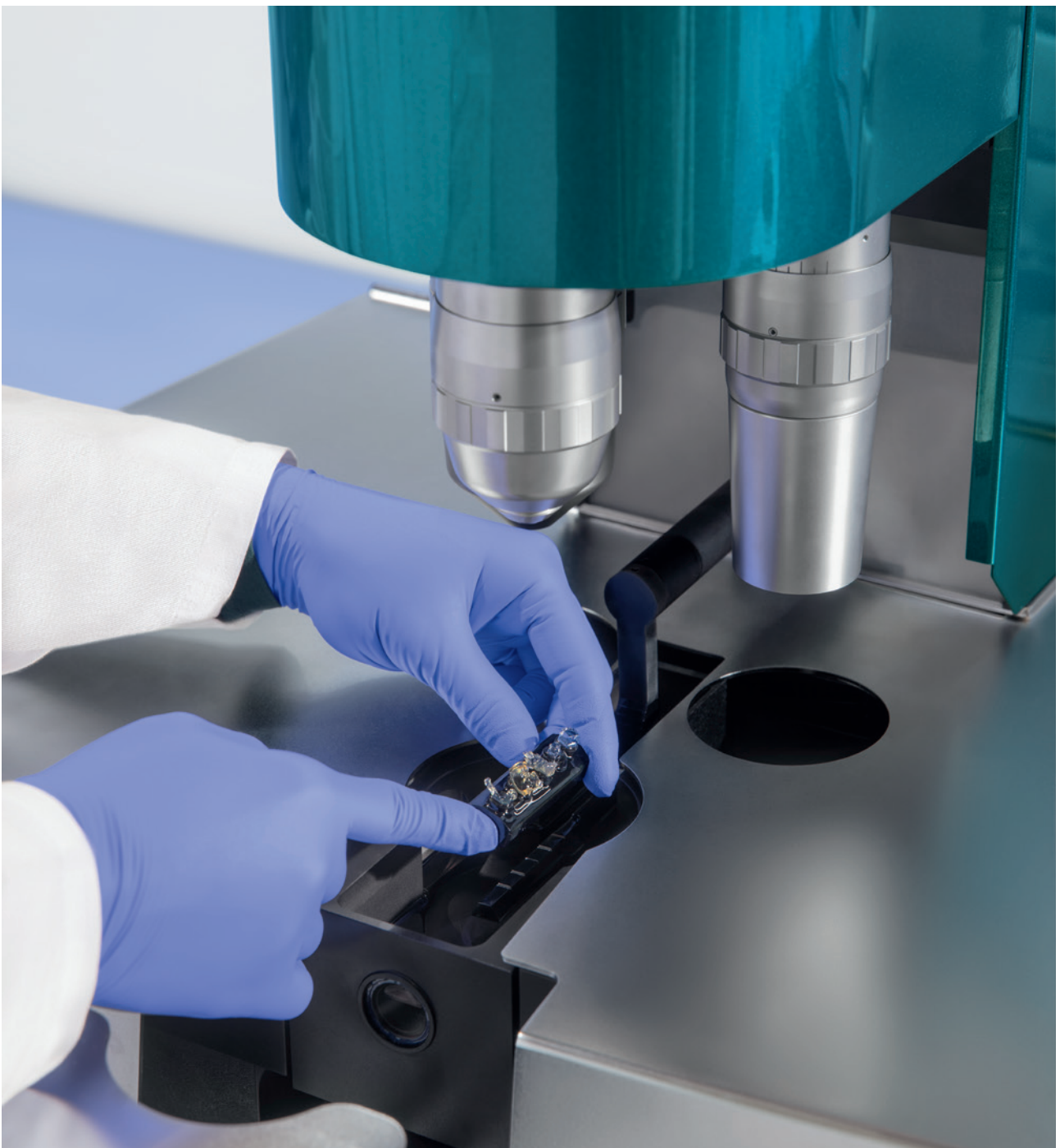

**Figure 1:** UltraMicroscope Blaze sample holder hosting five samples at the same time.

# Next-level light sheet imaging

The combination of our successful UltraMicroscope technology with the latest developments in the field of light sheet optics guarantees the best data quality. Flat-field correction in addition to long working distances makes the MI Plan objective lens series well suited for high-resolution imaging of large samples (fig. 2). In addition, they are compatible with all imaging solutions from water to solvents with high refractive indices. Explore our broad range of magnification options, from panoptic imaging at 0.66x to subcellular imaging at 30x.

## Six light sheets evenly illuminate the sample

The UltraMicroscope Blaze uses cutting-edge illumination optics to slightly tilt 2x3 bidirectional light sheets, with their Rayleigh lengths overlapping in the entire field of view. All six light sheets converge on the focal plane to illuminate all areas of the sample and minimize shadow artifacts. Get the most out of your sample with improved optical sectioning.

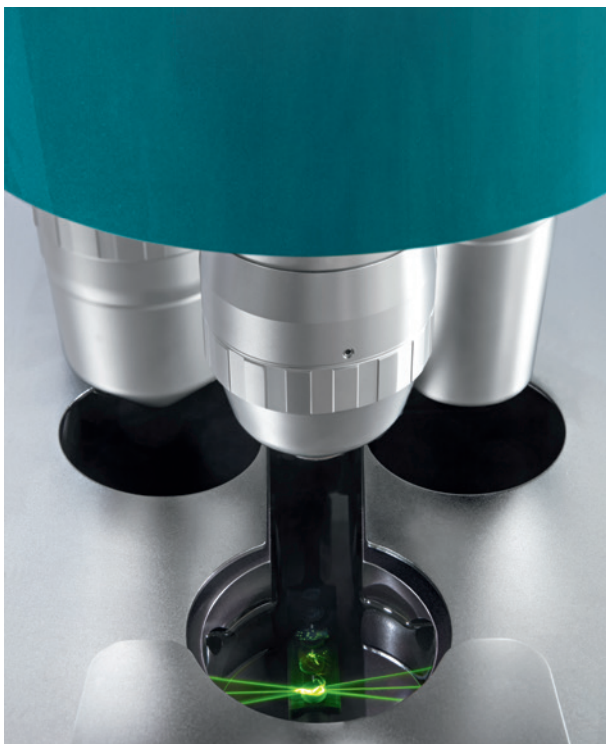

**Figure 2:** The UltraMicroscope Blaze can host up to three MI Plan objectives at the same time. Six light sheets provide homogeneous fluorescence excitation.

## Light sheet technology tailored to your sample

The light sheet approximates a plane only over a given horizontal range. This is where the light sheet is thinnest and where fluorescence detection takes place. To achieve an appropriate illumination for a particular sample, the planar range of the light sheet has to be matched with the sample size and the desired field of view (FOV). The light sheet of the UltraMicroscope Blaze is tailored to the sample size by using adjustable parameters. A low numerical aperture (NA) of illumination results in a broad FOV at the expense of a low z-resolution when imaging large samples (A). In contrast, a high NA results in a high z-resolution and a narrow FOV suitable for imaging small samples (B), with a full range of gradations in between. Where both high z-resolution and a large FOV are needed, a sequential series of high-resolution images are taken across the desired FOV and automatically merged into a single high-quality image.

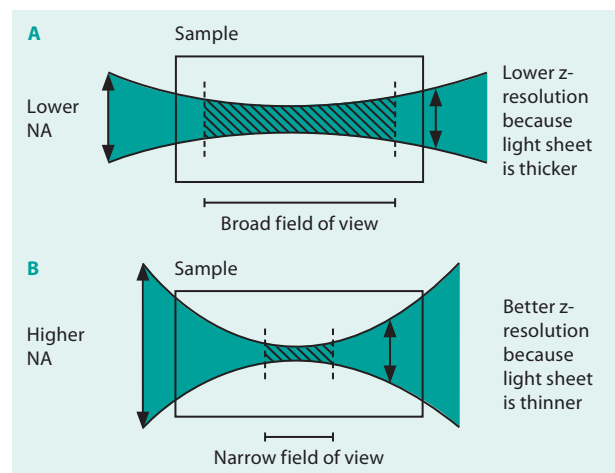

**Figure 3:** By adjusting the shape of the light sheets, illumination is tailored to sample size and imaging goals. A lower NA results in a broad field of view (A), and a higher NA results in a narrow field of view (B). While there is a tradeoff between the field of view, the thickness of the light sheet, and the z-resolution, the UltraMicroscope Blaze allows balancing these parameters to meet your specific requirements.

# Smooth and hassle-free 3D imaging with a complete workflow solution

Visualizing the three-dimensional architecture of complex biological systems is effortless thanks to the UltraMicroscope Blaze's automated processes. To provide a complete, smooth, and hassle-free 3D imaging workflow, Miltenyi Biotec also offers solutions for sample staining and clearing. Antibodies

specifically validated for 3D-immunofluorescence (IF) make time-consuming and costly validation processes obsolete. The MACS® Clearing Kit ensures fast and effective tissue clearing. And easy-to-follow protocols make this technology as easy as it gets, even if you are just about to start doing 3D imaging.



## 01 STAINING

Miltenyi Biotec's 3D-IF antibodies are specifically validated for whole-mount staining of large, cleared samples. For maximum reliability, ultimately producing conclusive results, these antibodies are functionally validated with the MACS Clearing Kit. Recombinantly engineered REAfinity™ Antibodies make for specific labeling and highly reproducible imaging data.

## 02 CLEARING

The MACS Clearing Kit provides a clearing process that is straightforward to use: fast, non-toxic, cost-effective, and easy. Clearing renders the optical properties of opaque organs transparent while keeping their structure intact. Following clearing, the sample is immersed in the non-toxic MACS Imaging Solution. Don't bother with toxic reagents in your 3D imaging workflow anymore.

## 03 AUTOMATED IMAGING

Multiple cleared samples can be imaged at once; each sample is excited by six focused light sheets and the resulting fluorescence is recorded. One sample after another is moved through the focal plane, exciting fluorophores at each layer and creating 3D image stacks while keeping photodamage and bleaching to a minimum.

VIDEO



See how easy it is to create detailed 3D images with our workflow solution:  
▶ [miltenyibiotec.com/UM-Blaze-workflow-video](https://miltenyibiotec.com/UM-Blaze-workflow-video)

LEARN MORE



Visit our webpage to learn more about the 3D imaging workflow:  
▶ [miltenyibiotec.com/3D-imaging-workflow](https://miltenyibiotec.com/3D-imaging-workflow)

# Antibodies validated for 3D imaging of cleared tissues

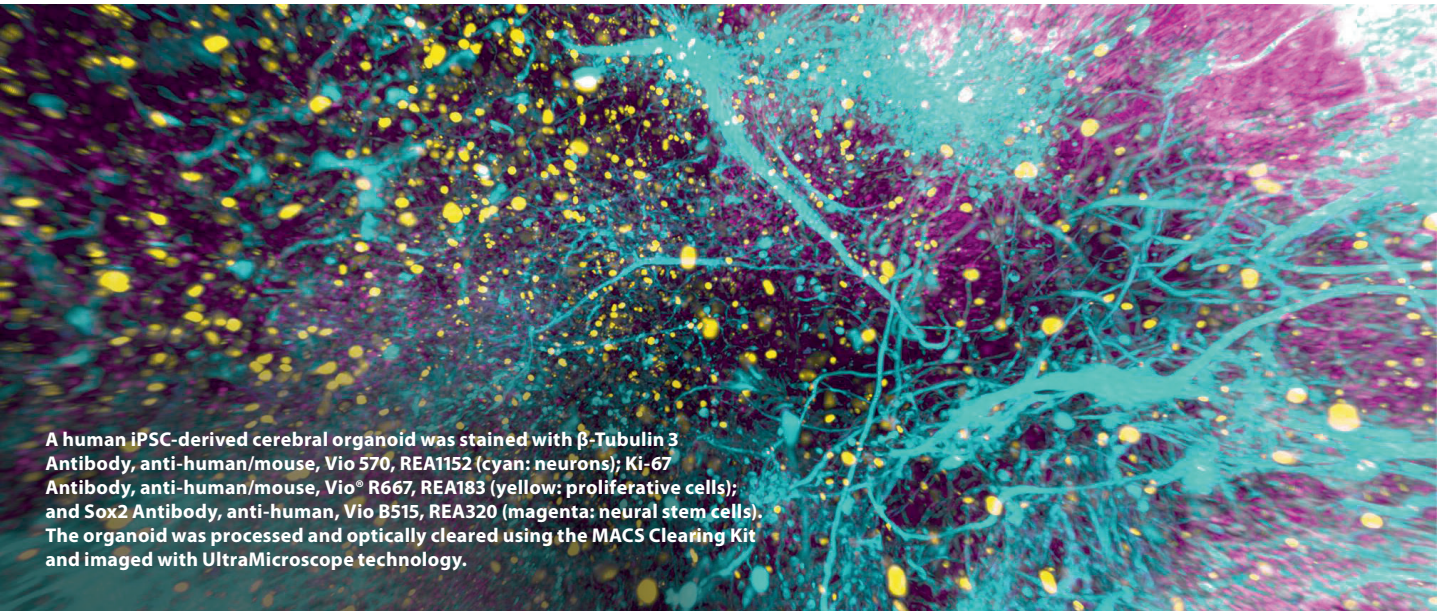

A human iPSC-derived cerebral organoid was stained with  $\beta$ -Tubulin 3 Antibody, anti-human/mouse, Vio 570, REA1152 (cyan: neurons); Ki-67 Antibody, anti-human/mouse, Vio® R667, REA183 (yellow: proliferative cells); and Sox2 Antibody, anti-human, Vio B515, REA320 (magenta: neural stem cells). The organoid was processed and optically cleared using the MACS Clearing Kit and imaged with UltraMicroscope technology.



Identifying appropriate antibodies to label structures of interest in large cleared samples is one of the most time-consuming steps in setting up the assays. Comprehensive screening and validation processes are needed to make sure that the antibodies give meaningful results. Miltenyi Biotec has already done this work for you: Recombinantly engineered REAfinity Antibodies are specifically validated and optimized for 3D-IF on tissues cleared with the MACS Clearing Kit.

- Validated and optimized for thorough whole-mount staining of large samples cleared with the MACS Clearing Kit
- Staining time decreased by 50% due to fluorochrome-conjugated primary antibodies
- Optimal signal-to-background ratios with primary antibodies conjugated to bright and photostable Vio® Dyes
- Recombinantly engineered for reproducible results and minimal background signals



LEARN MORE 



Check out our portfolio of 3D-IF antibodies.

► [miltenyibiotec.com/3D-IF-antibodies](https://miltenyibiotec.com/3D-IF-antibodies)



# Streamlined tissue clearing to get started immediately



Current protocols for tissue clearing involve laborious steps that often use toxic reagents to speed up the clearing process. We have established an easy and fast method to clear large tissue samples using a non-toxic organic solvent, providing the basis for the MACS Clearing Kit. This kit has been optimized for immunostaining with Miltenyi Biotec's 3D-IF antibodies for high-end imaging while completely avoiding toxic substances.

- Non-toxic, cost-effective, and easy: a clearing method that anyone can perform.
- Fast and efficient: one rapid clearing step that optimally clears samples and preserves tissue morphology.
- Versatile: clears various whole organs, including mouse brain and tumor tissue.
- Sharp images: Non-toxic MACS Imaging Solution, matching the refractive index of the cleared tissue, allows aberration-free image acquisition.

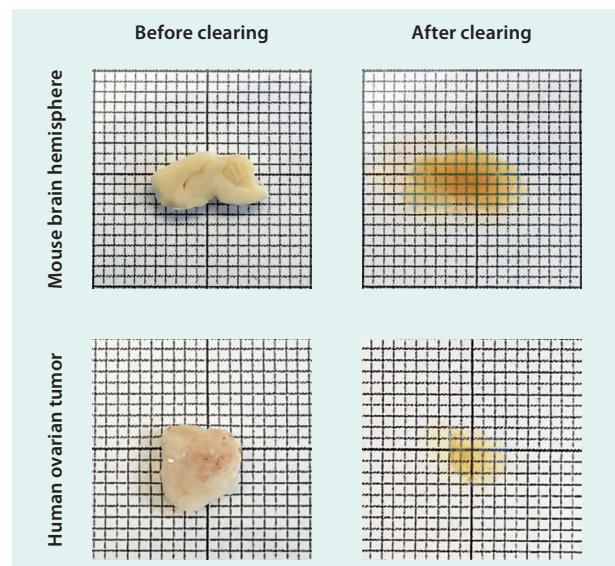

**Figure 4:** The MACS Clearing Kit enables effective clearing of a mouse brain hemisphere or human ovarian tumor within only six hours.

LEARN MORE



Browse our protocols to get started right away. You will find dedicated protocols for efficient clearing of samples like mouse brain hemispheres, human-derived xenograft tumors, and organoids.

► [miltenyibiotec.com/tissue-clearing-protocols](https://miltenyibiotec.com/tissue-clearing-protocols)

# Visualize and quantify CAR T cells in large solid tumors

The UltraMicroscope Blaze has many applications in immuno-oncology, such as

- visualization of single disseminated cancer cells in whole animal models,
- drug target identification for cancer treatments in a whole mouse body,
- section-free 3D histological analysis.

## **3D microscopy and deep learning reveal the heterogeneity of crown-like structure microenvironments in intact adipose tissue.**

Geng, J. *et al.* (2021) *Sci. Adv.* 7: eabe2480.

## **Identification and characterization of a non-conventional CD45 negative perivascular macrophage population within the mouse brain.**

Siret, C. *et al.* (2021) *Research Square*: preprint. DOI: 10.21203/rs.3.rs-479980/v1

## **Cellular and molecular probing of intact human organs.**

Zhao, S. *et al.* (2020) *Cell* 180, 1–17.

## **Deep learning reveals cancer metastasis and therapeutic antibody targeting in the entire body.**

Pan, C. *et al.* (2019) *Cell* 179: 1661–1676.e19.

## **Locally renewing resident synovial macrophages provide a protective barrier for the joint.**

Culemann, S. *et al.* (2019) *Nature* 572: 670–675.

## **Glioblastoma multiforme restructures the topological connectivity of cerebrovascular networks.**

Hahn, A. *et al.* (2019) *Scientific Reports* 9, 11757.

## **Correlated MRI and Ultramicroscopy (MR-UM) of brain tumors reveals vast heterogeneity of tumor infiltration and neoangiogenesis in preclinical models and human disease.**

Breckwoldt, M.O. *et al.* (2019) *Front. Neurosci.* 12, 1004.

Xenograft of a human pancreatic carcinoma cell line. Infiltrating CAR T cells were labeled with anti-human CD271 (LNGFR) Antibody (clone REA844) conjugated with Vio® 667 (violet). Vasculature was stained with rhodamine-conjugated lectin (orange). GFP-expressing tumor cells are shown in green.

VIDEO



Watch our 3D rendering of a pancreatic carcinoma xenograft.

► [miltenyibiotec.com/pancreas-carcinoma-video](https://miltenyibiotec.com/pancreas-carcinoma-video)

# Visualize micro-metastasis in an entire mouse body

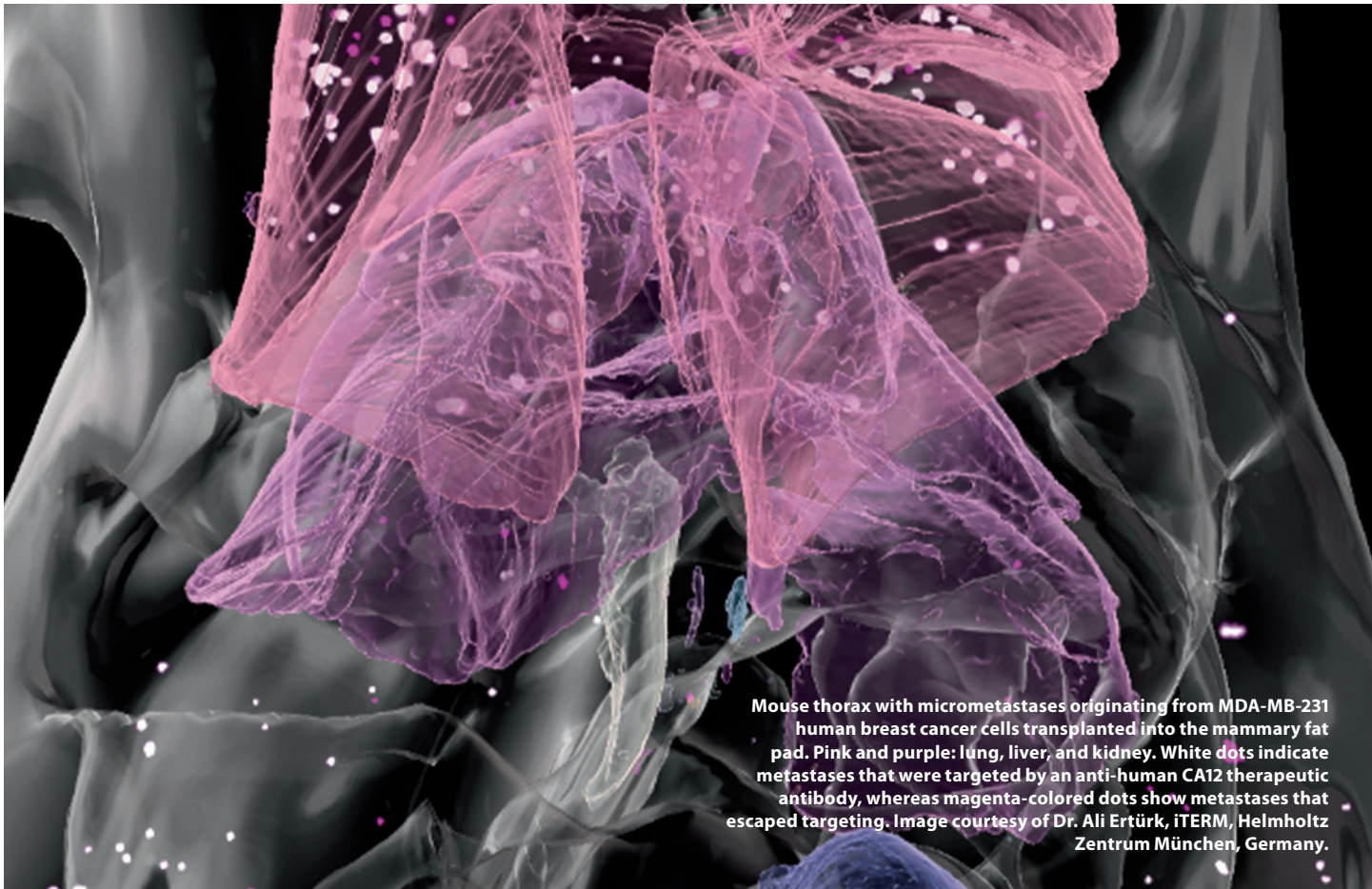

Mouse thorax with micrometastases originating from MDA-MB-231 human breast cancer cells transplanted into the mammary fat pad. Pink and purple: lung, liver, and kidney. White dots indicate metastases that were targeted by an anti-human CA12 therapeutic antibody, whereas magenta-colored dots show metastases that escaped targeting. Image courtesy of Dr. Ali Ertürk, iTERM, Helmholtz Zentrum München, Germany.

“

The UltraMicroscope Blaze allows us to see every single cancer metastasis in the whole bodies of transparent mice and we can also see if drugs are targeting all those tiny micro-metastases. The UltraMicroscope Blaze will be a powerful tool for drug development in oncology.

”

**Dr. Ali Ertürk, Director of iTERM, Helmholtz Zentrum München, Germany**



Copyright © IZB

LEARN MORE



Visit our webpage to learn how you can visualize single tumor cells in a whole mouse body.

► [miltenyibiotec.com/Blaze-oncology](https://miltenyibiotec.com/Blaze-oncology)

GET OUR LISTS



Download a list of selected references.

► [miltenyibiotec.com/UM-cancer-references](https://miltenyibiotec.com/UM-cancer-references)

# 3D neuroimaging across scales – from a whole mouse to single neurons

Understand the complex orchestration of neural circuits with whole-brain imaging at subcellular resolution. The UltraMicroscope Blaze offers many applications in neuroscience, such as

- system-level identification of neuronal circuits in whole brains at subcellular resolution,
- 3D study of the pathology of Alzheimer's and Parkinson's diseases in whole brains in unprecedented detail,
- holistic visualization of affected areas in the central and peripheral nervous system after stroke and traumatic brain injury.

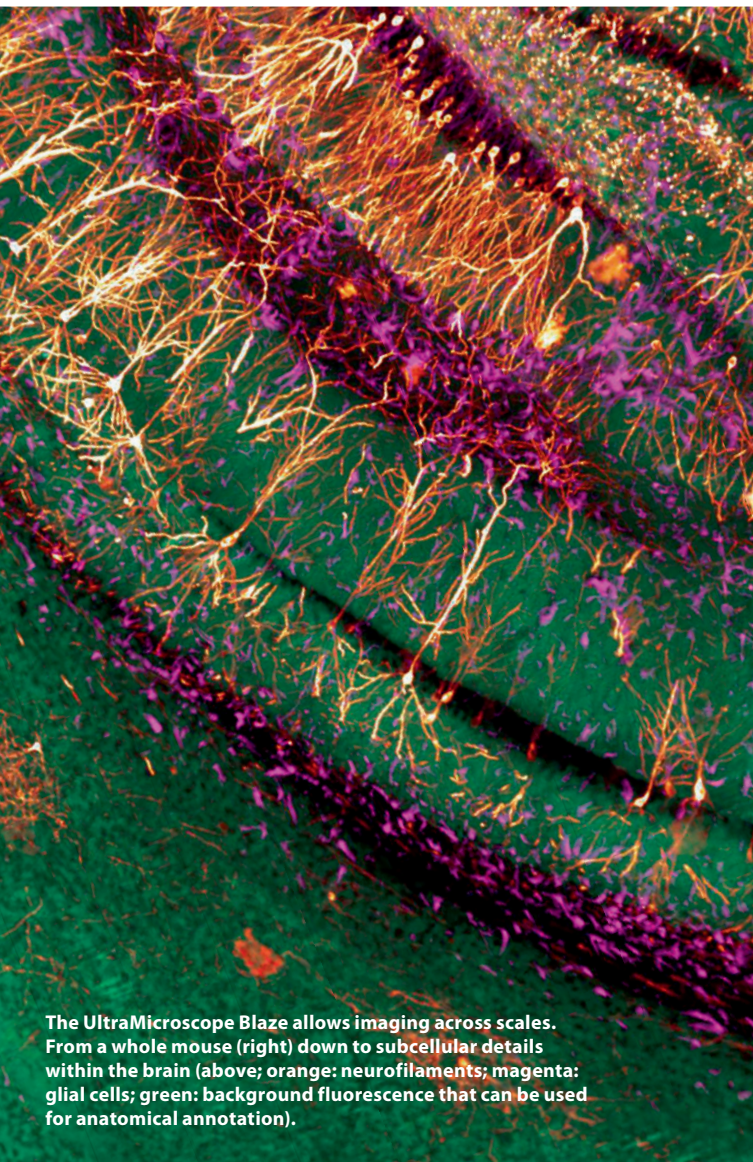

## **Microglia facilitate repair of demyelinated lesions via post-squalene sterol synthesis.**

Berghoff, S.A. *et al.* (2021) *Nat. Neurosci.* 24: 47–60.

## **Ventral arkypallidal neurons inhibit accumbal firing to promote reward consumption.**

Vachez, Y.M. *et al.* (2021) *Nat. Neurosci.* 24: 379–390.

## **Mapping the fine-scale organization and plasticity of the brain vasculature.**

Kirst, C. *et al.* (2020) *Cell* 180, 780–795.e25.

## **Circuit asymmetries underlie functional lateralization in the mouse auditory cortex.**

Levy, R.B. *et al.* (2019) *Nat. Commun.* 10: 2783.

## **GABAergic inhibition in dual-transmission cholinergic and GABAergic striatal interneurons is abolished in Parkinson disease.**

Lozovaya, N. *et al.* (2018) *Nat. Commun.* 9: 1422.

## **Three-dimensional study of Alzheimer's disease hallmarks using the iDISCO clearing method.**

Liebmann, T. *et al.* (2016) *Cell Rep.* 6: 1138–1152.

## **Mapping of brain activity by automated volume analysis of immediate early genes.**

Renier, N. *et al.* (2016) *Cell* 165: 1789–1802.

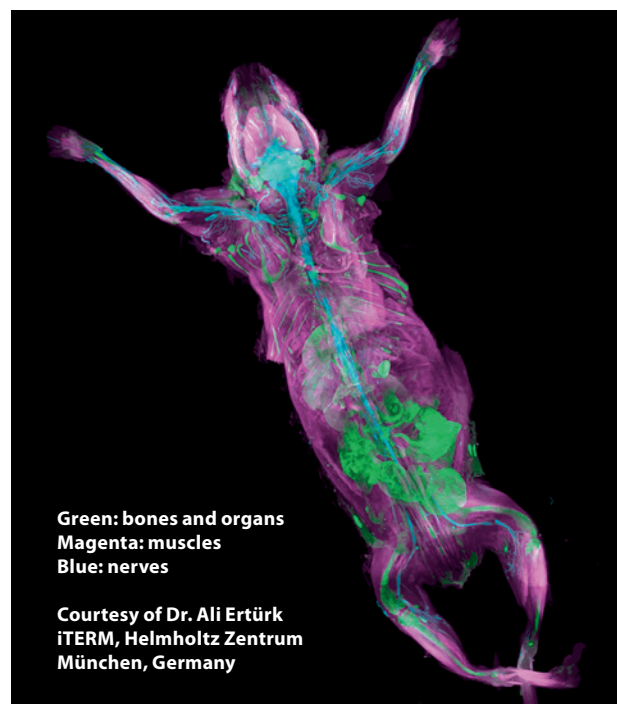

# Visualize an entire brain at subcellular resolution

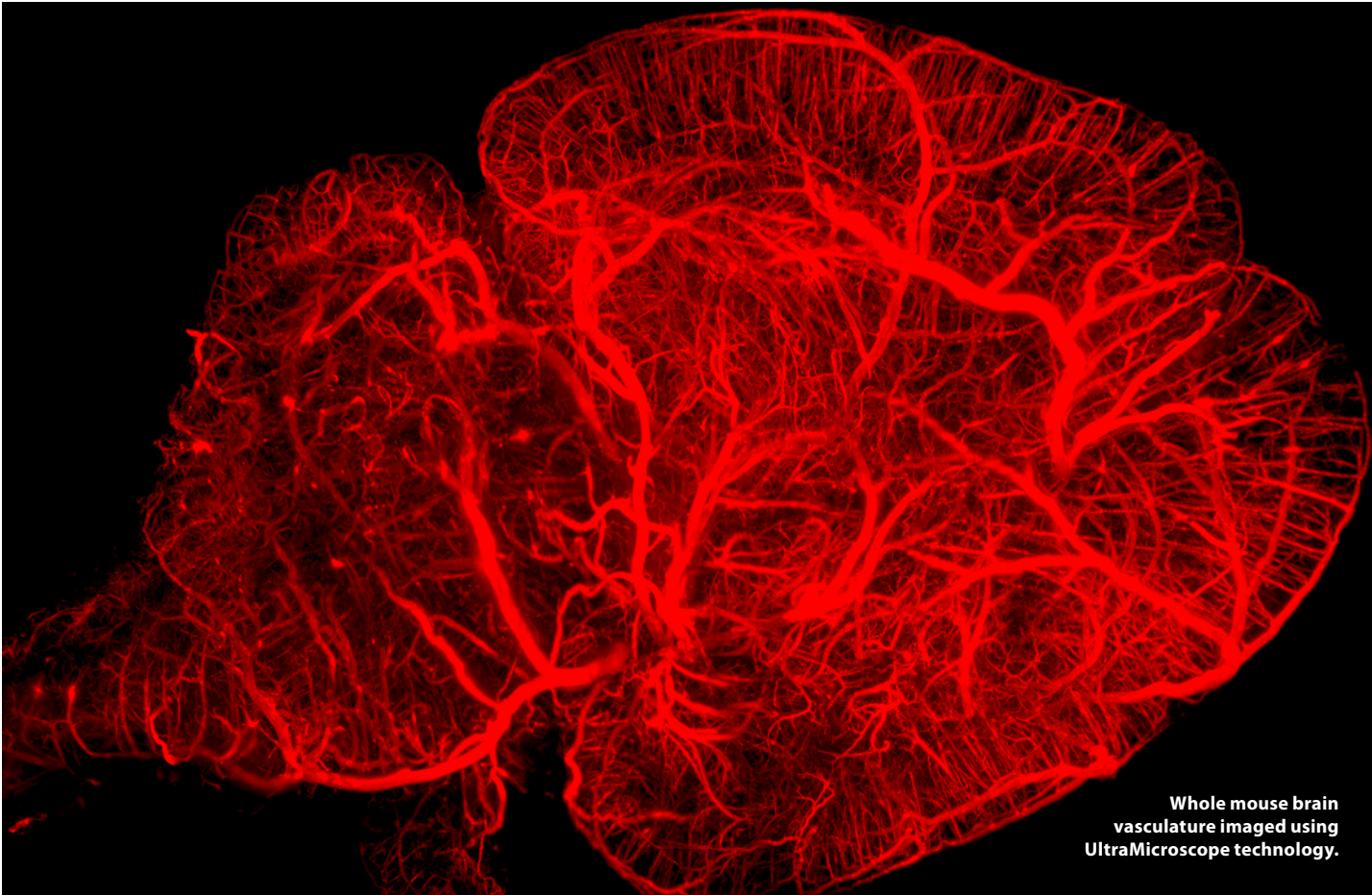

“

To understand the nervous system's architecture and function, we require comprehensive 3D data. The UltraMicroscope Blaze provides us that in spades, and the new insights we gain from these 3D images definitely change the way we see the brain.

”

**Dr. Alain Chédotal,**  
Sorbonne Université, INSERM,  
CNRS, Institut de la Vision,  
Paris, France



GET OUR LISTS



Download a list of selected references.

► [miltenyibiotec.com/UM-neuroscience-references](https://miltenyibiotec.com/UM-neuroscience-references)

# Specifications

The UltraMicroscope Blaze can host three MI Plan objective lenses that can be exchanged automatically. Total magnification ranges from 0.66x to 30x thanks to

the automated magnification changer. The instrument can be equipped with either a 4.2 MP or a 5.5 MP sCMOS camera.

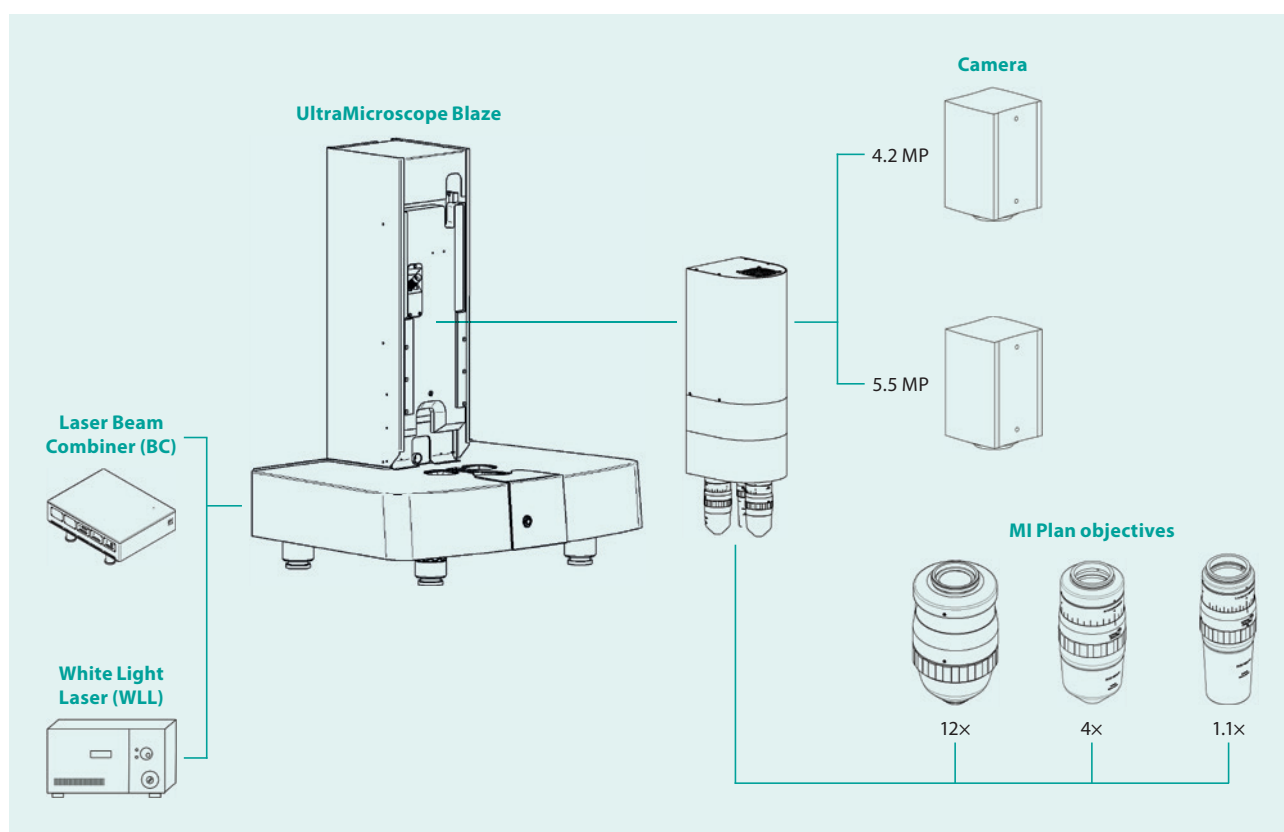

**Figure 4:** Overview of the UltraMicroscope Blaze configurations.

## UltraMicroscope Blaze Instrument specifications

| Sheet optics                       |  |
|------------------------------------|--|
| Illumination                       | Uni- and bidirectional   |
| Number of light sheets             | 1–6  |
| Thickness                          | 4–24 $\mu\text{m}$   |
| Width                              | 1–20 mm  |
| Numerical aperture                 | 0.0135–0.135   |
| Focus positioning                  | Dynamic  |
| Refractive index (RI) compensation | Software-controlled automated RI compensation over the range of 1.33–1.56, covering all clearing media |

## UltraMicroscope Blaze Instrument specifications (cont.)

### Light sources

|                    |   |
|--------------------|---|
| Laser BC           | Max. 5 laser lines (405, 488, 561, 639, 785 nm)*, 50–100 mW per diode |
| Supercontinuum WLL | Spectral range depending on the laser module (e.g. 410–800 nm)        |

### Detection optics

|   |   |            |           |
|---|---|------------|-----------|
| Objective lenses                        | 1.1×  | 4×         | 12×       |
| Total magnification                     | 0.66–2.75×  | 2.4–10×    | 7.2–30×   |
| Numerical aperture                      | 0.1   | 0.35       | 0.53      |
| Max. theoretical resolution at detector | 4.8 μm  | 1.3 μm     | 0.5 μm    |
| Working distance                        | ≤17 mm  | ≤16 mm     | ≤10.9 mm  |
| FOV diagonal (5.5 MP camera)            | 7.9–33 mm   | 2.2–9.1 mm | 0.73–3 mm |
| Emission filters                        | Seven filters Ø 43 mm   |            |           |
| Chromatic correction                    | Software-controlled automatic chromatic correction in the range of 400–850 nm |            |           |
| Focusing                                | Software-controlled autofocus   |            |           |
| Objective change                        | Motorized turret allows automated change of objective lenses.                 |            |           |
| Magnification change                    | Software-controlled automated magnification changer for all objective lenses  |            |           |

### Camera specifications

|                            |                                     |                                   |
|----------------------------|-------------------------------------|-----------------------------------|
| Detector                   | 4.2 Megapixel sCMOS camera          | 5.5 Megapixel sCMOS camera        |
| Active pixels (w×h)        | 2048×2048                           | 2560×2160                         |
| Pixel size                 | 6.5 μm × 6.5 μm                     | 6.5 μm × 6.5 μm                   |
| Sensor size                | 13.3 mm × 13.3 mm; 18.8 mm diagonal | 16.6 mm × 14 mm; 21.8 mm diagonal |
| Readout noise              | 0.8 med e <sup>-</sup>              | 1 med e <sup>-</sup>              |
| Maximal frame rates        | 100 fps                             | 100 fps                           |
| Maximum quantum efficiency | 82%                                 | 60%                               |

### Image chamber

|                               |   |
|-------------------------------|---|
| Imaging solution              | Aqueous buffers and organic solvents  |
| Sample travel range (x, y, z) | 24 mm, 50 mm, 23 mm   |
| Chamber size                  | 51 mm × 129 mm × 64 mm  |
| Sample mounting assistance    | Easy access to sample holder by automated movement of the sample chamber from measurement to parking position |
| Multisample measurement       | Batch measurement mode for automated sequential imaging of multiple samples in one experiment                 |

### General information

|                    |                                  |
|--------------------|----------------------------------|
| Dimensions (w×h×d) | 67 cm × 91 cm × 52.5 cm          |
| Weight             | 98 kg (w/o controller and laser) |

\*Five out of eleven available laser lines can be chosen for the Beam Combiner.



**Miltényi Biotec**

**Germany/Austria**

Miltényi Biotec B.V. & Co. KG  
Friedrich-Ebert-Straße 68  
51429 Bergisch Gladbach  
Germany  
Phone +49 2204 8306-0  
Fax +49 2204 85197  
macsde@miltényi.com

**USA/Canada**

Miltényi Biotec, Inc.  
2303 Lindbergh Street  
Auburn, CA 95602, USA  
Phone 800 FOR MACS  
Phone +1 866 811 4466  
Fax +1 877 591 1060  
macsus@miltényi.com

**Australia**

Miltényi Biotec  
Australia Pty. Ltd.  
Unit 11, 2 Eden Park Drive  
Macquarie Park, NSW 2113  
Australia  
Phone +61 2 8877 7400  
Fax +61 2 9889 5044  
macsau@miltényi.com

**Benelux**

Miltényi Biotec B.V.  
Sandifortdreef 17  
2333 ZZ Leiden  
The Netherlands  
macsnl@miltényi.com

**Customer service**

**The Netherlands**  
Phone 0800 4020120  
Fax 0800 4020100

**Customer service Belgium**

Phone 0800 94016  
Fax 0800 99626

**Customer service Luxembourg**

Phone 800 24971  
Fax 800 24984

**China**

Miltényi Biotec Technology &  
Trading (Shanghai) Co., Ltd.  
Room 401  
No. 1077, Zhangheng Road  
Pudong New Area  
201203 Shanghai, P.R. China  
Phone +86 21 6235 1005-0  
Fax +86 21 6235 0953  
macscn@miltényi.com

**France**

Miltényi Biotec SAS  
10 rue Mercœur  
75011 Paris, France  
Phone +33 1 56 98 16 16  
macsfr@miltényi.com

**Hong Kong**

Miltényi Biotec Hong Kong Ltd.  
Unit 301, Lakeside 1  
No. 8 Science Park West Avenue  
Hong Kong Science Park  
Pak Shek Kok, New Territories  
Hong Kong  
Phone +852 3751 6698  
Fax +852 3619 5772  
macshk@miltényi.com

**Italy**

Miltényi Biotec S.r.l.  
Via Paolo Nanni Costa, 30  
40133 Bologna  
Italy  
Phone +39 051 6 460 411  
Fax +39 051 6 460 499  
macsit@miltényi.com

**Japan**

Miltényi Biotec K.K.  
NEX-Eitai Building 5F  
16-10 Fuyuki, Koto-ku  
Tokyo 135-0041, Japan  
Phone +81 3 5646 8910  
Fax +81 3 5646 8911  
macsjp@miltényi.com

**Nordics and Baltics**

Miltényi Biotec Norden AB  
Medicon Village  
Scheeletorget 1  
223 81 Lund  
Sweden  
macsse@miltényi.com

**Customer service Sweden**

Phone 0200 111 800  
Fax +46 280 72 99

**Customer service Denmark**

Phone 80 20 30 10  
Fax +46 46 280 72 99

**Customer service**

**Norway, Finland, Iceland,  
and Baltic countries**

Phone +46 46 280 72 80  
Fax +46 46 280 72 99

**Singapore**

Miltényi Biotec Asia Pacific Pte Ltd.  
438B Alexandra Road, Block B  
Alexandra Technopark  
#06-01  
Singapore 119968  
Phone +65 6238 8183  
Fax +65 6238 0302  
macssg@miltényi.com

**South Korea**

Miltényi Biotec Korea Co., Ltd.  
Arigi Bldg. 8F  
562 Nonhyeon-ro  
Gangnam-gu  
Seoul 06136, South Korea  
Phone +82 2 555 1988  
Fax +82 2 555 8890  
macskr@miltényi.com

**Spain**

Miltényi Biotec S.L.  
C/Luis Buñuel 2  
Ciudad de la Imagen  
28223 Pozuelo de Alarcón (Madrid)  
Spain  
Phone +34 91 512 12 90  
Fax +34 91 512 12 91  
macses@miltényi.com

**Switzerland**

Miltényi Biotec Swiss AG  
Gibelinstrasse 27  
4500 Solothurn  
Switzerland  
Phone +41 32 623 08 47  
Fax +49 2204 85197  
macsch@miltényi.com

**United Kingdom**

Miltényi Biotec Ltd.  
Almac House, Church Lane  
Bisley, Surrey GU24 9DR, UK  
Phone +44 1483 799 800  
Fax +44 1483 799 811  
macsuk@miltényi.com

**www.miltényibiotec.com**

Miltényi Biotec provides products and services worldwide. Visit [www.miltényibiotec.com/local](http://www.miltényibiotec.com/local) to find your nearest Miltényi Biotec contact.

Unless otherwise specifically indicated, Miltényi Biotec products and services are for research use only and not for therapeutic or diagnostic use. Blaze, MACS, the Miltényi Biotec logo, REAfinity, and Vio, are registered trademarks or trademarks of Miltényi Biotec and/or its affiliates in various countries worldwide. Copyright © 2021 Miltényi Biotec and/or its affiliates. All rights reserved.