



Features and Benefits

- **Broad wavelength coverage**
Now available with BR-DD (red/NIR), BEX2-DD (UV-NIR Broadband) and BU2 (UV/blue) sensor options
- **TE cooling to -100°C**
Critical for elimination of dark current detection limit
- **Fringe Suppression Technology™**
NIR etaloning greatly reduced (BR-DD and BEX2-DD sensor types)
- **4-speed readout up to 5 MHz** *10
Slower readout for low noise, faster speeds for dynamic processes and 5 MHz for visualization mode
- **Ultra low noise readout**
Intelligent low-noise electronics offer the most 'silent' system noise performance available
- **Large area 2048 x 2048 sensor**
Large field of view and high resolution
- **UltraVac™** *1
Critical for sustained vacuum integrity and to maintain unequalled cooling and QE performance, year after year
- **Integrated shutter** **2
F-mount (EF optional) with integrated programmable 45 mm shutter
- **Fast Kinetics & Cropped Sensor modes**
For fast temporal resolution down to sub-millisecond
- **ASTRO.control compatibility**
Redlogix ASTRO.control is a dedicated platform for control of astronomical telescopes and instrumentation
<http://www.andor.com/astrocontrol.aspx>
- **Windows, Linux & Labview**
Andor's user-friendly SDK supports both Windows and Linux OS. Labview VI package available

-100°C Deep-Cooled CCD for Large Area Imaging

Andor's iKon-L 936 is designed with scientific imaging in mind. The 2048 x 2048 array and 13.5 µm pixel pitch combine to deliver a 27.6 x 27.6 mm active image area, TE cooled down to -100°C. The iKon-L offers outstanding resolution, field of view, sensitivity and dynamic range performance. Ultimate sensitivity performance is achieved through combination of > 90% QE (back-illuminated sensor), low noise readout electronics and exceptionally deep TE cooling. The new Dual AR deep depletion 'BEX2-DD' sensor option provides an unmatched QE profile, offering highest possible QE from UV through to NIR.

iKon-L boasts a proprietary large area 5-stage TE cooler (4-stage optional), enabling cooling of this large area sensor down to an unprecedented -100°C without the aggravation of liquid nitrogen or compressed gas cooling, perfect for the longest of exposure times. Such performance renders this camera ideal for low-light applications such as astronomy, plant or *in vivo* luminescence imaging, with ideal OEM adaptability and support. USB 2.0 connectivity and multi-MHz readout options provide for ease of integration and operation.

Specifications Summary^{*3}

Active pixels	2048 x 2048
Sensor size	27.6 x 27.6 mm
Pixel size (W x H)	13.5 µm x 13.5 µm
Active area pixel well depth	100,000 e ⁻ (150,000 e ⁻ for BEX2-DD and BR-DD models)
Maximum readout rate	5 MHz
Read noise	2.9 e ⁻
Maximum cooling	-100°C
Frame rate	0.95 fps (full frame)

System Specifications^{*3}

Sensor options	BV: Back Illuminated CCD, Vis optimized BU2: Back Illuminated CCD, UV-Enhanced, 250 nm optimized FI: Front Illuminated CCD BR-DD: Back Illuminated CCD, Deep Depletion with fringe suppression. Optimum sensor for Near IR applications. BEX2-DD: Back Illuminated CCD, Deep Depletion with fringe suppression, extended range dual AR coating	
Active pixels ^{*4}	2048 x 2048	
Pixel size	13.5 x 13.5 μm	
Image area	27.6 x 27.6 mm with 100% fill factor	
Minimum temperatures ^{*5}	4-stage peltier cooler	5-stage peltier cooler
Air cooled	-70°C	-80°C
Coolant recirculator	-75°C	-95°C
Coolant chiller, coolant @ 10°C, 0.75 l/min	-80°C	-100°C
Blemish specification	Grade 1 sensor from supplier. Camera blemishes as defined by Andor Grade A: www.andor.com/learning-academy/ccd-blemishes-and-non-uniformities-black-pixels-and-hot-pixels-on-a-ccd-sensor	
System window type	BV, BR-DD sensors: UV-grade fused silica, 'Broadband VIS-NIR', unwedged BU2, FI, BEX2-DD sensors: UV-grade fused silica, 'Broadband VUV-NIR', unwedged (other options available e.g. Bose-Einstein 780nm for Rb BEC experiments)	

Advanced Performance Specifications^{*3}

Dark current, e⁻/pixel/sec ^{*6}	BV, BU2, FI sensors	BR-DD, BEX2-DD sensors
@ -70°C	0.00040	0.020
@ -80°C	0.00013	0.006
@ -100°C (5-stage peltier cooler model only)	0.000059	0.0003
Pixel readout rates	5, 3, 1, 0.05 MHz	
Active area pixel well depth	100,000 e ⁻	150,000 e ⁻
Read noise (e⁻) ^{*7}	High Sensitivity output	High Capacity output
0.05 MHz	2.9	8.7
1 MHz	7.0	22.2
3 MHz	11.7	40.2
5 MHz ^{*10}	31.5	70.3
Linearity ^{*8}	Better than 99%	
Digitization	16-bit	
Vertical clock speed	38 or 76 μs (software selectable)	

Frame Rates^{*9}

50 kHz			
Binning	Full Frame	1024 x 1024	512 x 512
1 x 1	0.011	0.023	0.046
2 x 2	0.040	0.059	0.102
4 x 4	0.155	0.138	0.213
8 x 8	0.482	0.293	0.420
16 x 16	1.166	0.572	0.780

1 MHz			
Binning	Full Frame	1024 x 1024	512 x 512
1 x 1	0.221	0.433	0.835
2 x 2	0.662	0.993	1.670
4 x 4	1.594	1.947	2.951
8 x 8	2.912	3.266	4.571
16 x 16	4.152	4.710	6.204

3 MHz			
Binning	Full Frame	1024 x 1024	512 x 512
1 x 1	0.607	1.157	2.115
2 x 2	1.294	2.175	3.588
4 x 4	2.305	3.545	5.326
8 x 8	3.463	5.017	6.953
16 x 16	4.496	6.270	8.180

5 MHz (Visualization mode) ^{*10}			
Binning	Full Frame	1024 x 1024	512 x 512
1 x 1	0.953	1.771	3.100
2 x 2	1.655	2.922	4.733
4 x 4	2.619	4.329	6.424
8 x 8	3.697	5.700	7.822
16 x 16	4.654	6.776	8.777

Application Focus: Physical Sciences

Astronomy - Exoplanet Discovery

One of the key goals of Exoplanet science is to discover planets similar in size and composition to Earth. Using the latest in imaging technology, planets in this size domain can be most easily discovered around M-dwarf stars. An Earth-sized exoplanet transiting an M-dwarf star causes a more significant decrease in stellar brightness than the same planet orbiting a Sun-like star. However, detecting transit signatures of planets of this kind remains challenging due to the planet's small relative sizes and/or faint host stars, combined with limited sensitivities of existing instruments.

Andor's large area iKon-L and **iKon-XL** back-illuminated CCD cameras represent ideal solutions for exoplanet science, due to the sensor's high sensitivity, extended NIR sensitivity and high QE coverage (>90% peak QE) in combination with a low noise floor supporting high precision photometry.

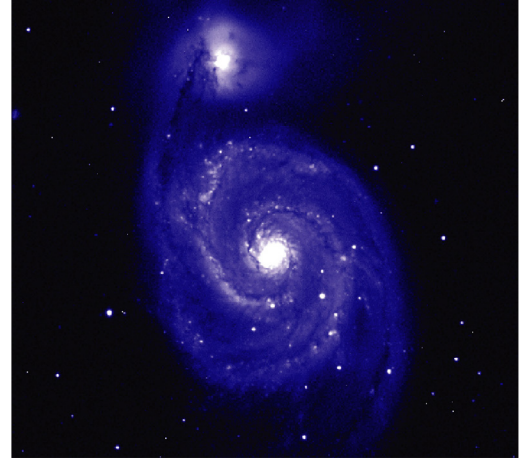

Two interacting galaxies, M51 (Whirlpool Galaxy) & NGC 5195. Courtesy of Prof. Andrzej Pigulski, Wroclaw University, Poland.

Low Maintenance Astronomy

Andor's UltraVac™ Technology is particularly relevant for astronomy applications. Cameras are often in remote unmanned observation locations and need to operate without service intervention, over long durations of time. The sustained vacuum integrity of Andor's UltraVac™ Technology prevents the need for re-pumping and experiment down-time, resulting in higher experimental throughput, and a lower cost of ownership.

- ✓ NO Liquid Nitrogen
- ✓ NO Vacuum re-pump
- ✓ NO Cryo cooler
- ✓ NO Return to base

Bose-Einstein Condensation (BEC)

The high and broad QE profile of the iKon-L provides excellent coverage of the visible / NIR wavelength range, often needed to image ultracold fermions at wavelengths of 670 nm and above, in both fluorescence and absorption type set-ups.

Hyper-Spectral Imaging

Often there is a desire for the highest number of spectral channels possible with ideal resolution; the large FOV and pixel size of the iKon series offers significant extensions to hyper spectral imaging.

Neutron Radiography

Traditionally CCD's have been used as imaging cameras for neutron tomography. Andor's scientific range of imaging cameras are ideal with their extremely low noise, -100 °C cooling and highest QE delivering optimal performance.

Quantum Efficiency Curves **

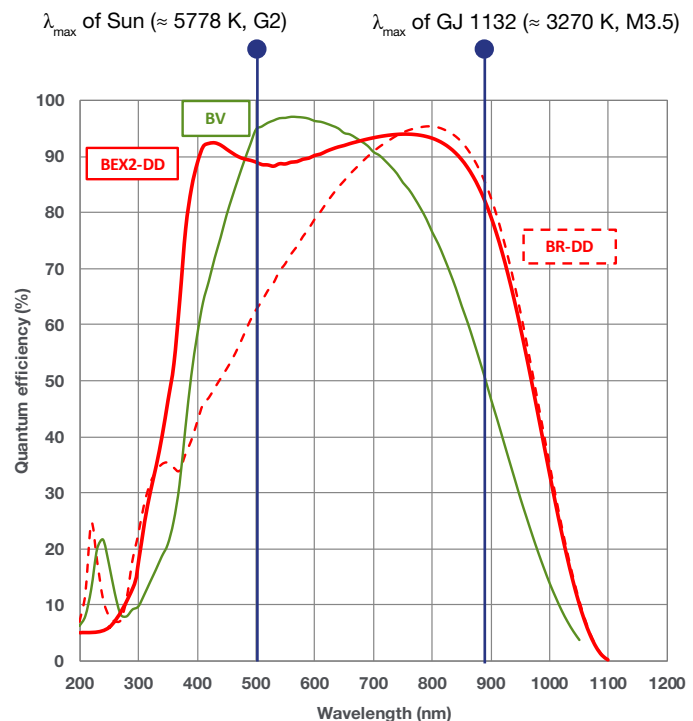

Quantum efficiency against wavelength of the standard Silicon ('BV') and deep depletion ('BR-DD' and 'BEX2-DD') iKon-L sensor options. Overlaid are the peak wavelengths λ_{\max} of the Sun and the exoplanet hosting M-dwarf GJ 1132. This highlights the higher quantum efficiency in the NIR using deep depletion sensors, which is of great importance for observations of cool stars, such as M-dwarfs.

Application Focus: Life Science

iKon-L is suitable for life science applications that require longer exposures and benefit from the lowest possible dark current that is not possible with “fast” sCMOS cameras. Such applications include:

- ✓ **Fluorescence Microscopy**
- ✓ **Biochip Reading**
- ✓ **Bio/Chemi - Luminescence**
- ✓ **In-Vivo Luminescence**
- ✓ **Laser Induced Fluorescence (LIF)**

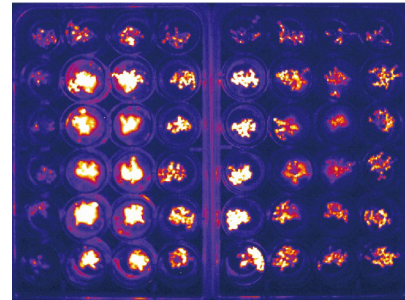

Example of bioluminescence timelapse of Arabidopsis to investigate the circadian clock. Courtesy of Professor Liu (Liu Lab, Shanghai Institutes for Biological Sciences, CAS, Shanghai). Taken with the iKon series, [read more here](#).

Plant Science Research

Studies of plant species such as *A. thaliana* using luminescence based experiments provide an effective means to study many aspects of plant growth, development and regulation. Such experiments involve measurement of weak signals over extended periods. The iKon series is perfectly suited to these applications. Exceptional sensitivity extends across the 400 to 700 nm region. The deep cooled sensors provides the lowest noise floor enabling extended exposures beyond seconds into minutes. The iKon-L model has a wide field of view meaning that larger areas and more data can be viewed and analyzed.

Biochip Reading

Biochip experiments vary widely with some requiring long exposures to detect faintly emitted signals. For these experiments the iKon series is an ideal option due to the high sensitivity and lowest noise floor over extended exposures times. The large 27.6 x 27.6 mm sensor format allows for the maximum image information to be acquired in each snap. When higher speed acquisition is required we recommend the higher speeds of sCMOS cameras such as the Zyla series.

Quantum Efficiency Curves ^{*11}

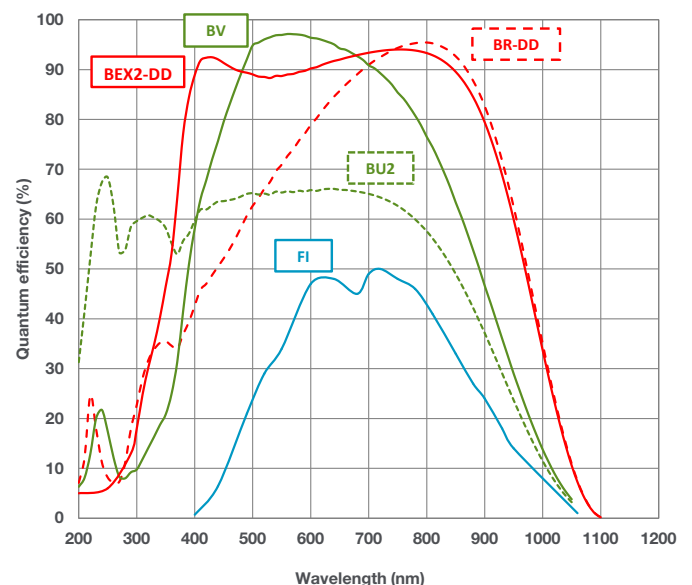

Have you found what you're looking for?

Need the ultimate in sensitivity? The iKon back-illuminated EMCCD series offers > 90% QE and single photon sensitivity, combined with fast frame rate performance.

Need a large field of view with faster frame rates? The Neo and Zyla sCMOS are available in a large 5.5 megapixel sensor format that offers up to 100 fps (full frame). The iKon Ultra 888 offers ultimate sensitivity at 26 fps. The Sona 4.2B-11 back-illuminated sCMOS has exceptional sensitivity and the largest field of view with a 32 mm diagonal.

Need smaller pixels? Check out the new Sona 4.2B-6 sCMOS with smaller 6.5 µm pixels.

Need a customised version? Please contact us to discuss our Customer Special Request options. <https://andor.oxinst.com/contact>

[oxinst.com/contact](https://andor.oxinst.com/contact)

Creating The Optimum Product for You



D Z 936N- FI
example shown

Step 1. Choose the cooling option



Cooling

Description	Code
4-stage peltier cooling (Air cooled : -70°C, Coolant recirculator: -75°C, Coolant chiller, coolant @ 10°C, 0.75 l/min: -80°C)	W
5-stage peltier cooling (Air cooled: -80°C, Coolant recirculator: -95°C, Coolant chiller, coolant @ 10°C, 0.75 l/min: -100°C)	Z

Step 2. Choose the sensor type option



Sensor Type

Description	Code
Back Illuminated CCD	BV
Front Illuminated CCD	FI
Back Illuminated CCD, AR coated for optimized performance in the 250 nm region	BU2
Back Illuminated CCD, Deep Depletion with fringe suppression. Optimum sensor for Near IR applications.	BR-DD
Back Illuminated CCD, Deep Depletion with fringe suppression, extended range dual AR coating	BEX2-DD

Step 3. Select an alternative camera window (optional)



Camera Window

The standard window has been selected to satisfy most applications. However, other options are available. The alternative camera window code must be specified at time of ordering.

To view and select other window options please refer to the '[Camera Windows Supplementary Specification Sheet](#)' which gives the transmission characteristics, product codes and procedure for entering the order. Further detailed information on the windows can be found in the Technical note – '[Camera Windows: Optimizing for Different Spectral Regions](#)'.

Step 4. Select the required accessories and adapters



Accessories & Adapters

Description	Order Code
Re-circulator for enhanced cooling performance	XW-RECR
Oasis 160 Ultra compact chiller unit (tubing to be ordered separately)	ACC-XW-CHIL-160
6 mm tubing options for ACC-XW-CHIL-160 (2x2.5 m or 2x5m lengths)	ACC-6MM-TUBING-2X2.5 ACC-6MM-TUBING-2X5M
Auto extension tubes (set of 3) for Nikon F	OA-ENAF
USB Extender: Icron USB 2.0 Ranger 2201 (supports up to 100 m) - EU/UK/US	ACC-USBX-EU ACC-USBX-UK ACC-USBX-US
30 m Ethernet cable (for use with the above ACC-USBX-** USB extenders)	ACC-ELC-13295

Step 5. Select the required software



Software

The iKon-L requires at least one of the following software options:

Solis for Imaging A 32-bit and fully 64-bit enabled application for Windows (8, 8.1 and 10) Linux and Labview, offering rich functionality for data acquisition and processing. AndorBasic provides macro language control of data acquisition, processing, display and export.

Andor SDK A software development kit that allows you to control the Andor range of cameras from your own application. Available as 32/64-bit libraries for Windows (8, 8.1 and 10), compatible with C/C++, C#, Delphi, VB.NET, LabVIEW and Matlab. Linux SDK compatible with C/C++.

Third party software compatibility Drivers are available so that the iKon-L range can be operated through a large variety of third party imaging packages. See Andor web site for detail: www.andor.com/software/

Product Drawings

Dimensions in mm [inches]

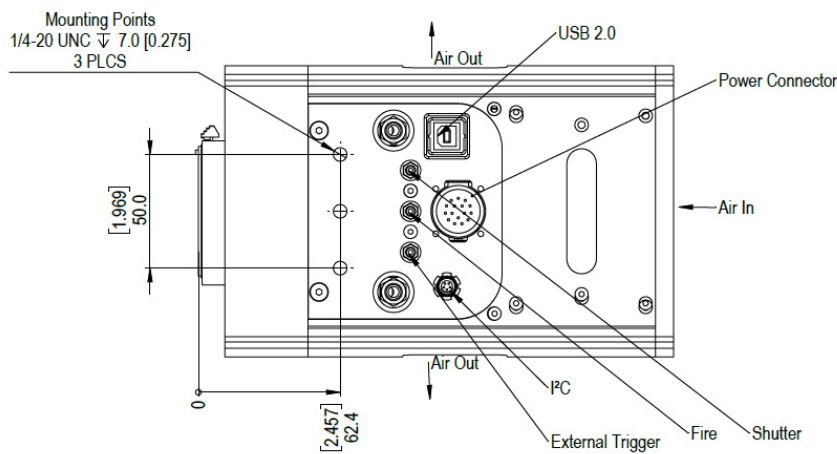
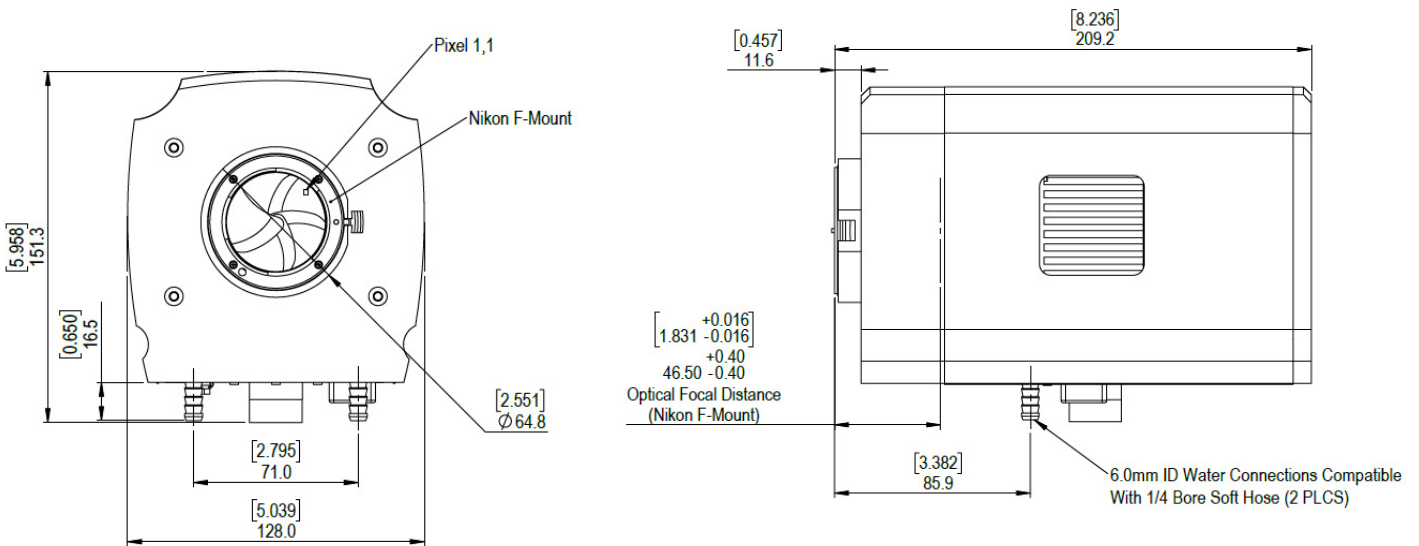
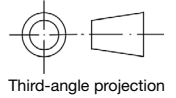

Weight: 4.6 kg [10.2 lb]

Connecting to the iKon-L

Camera Control

Connector type: USB 2.0

TTL / Logic

Connector type: SMB, provided with SMB - BNC cable
Fire (Output), External Trigger (Input), Shutter (Output)

I²C connector

Compatible with Fischer SC102A054-130
Shutter (TTL), I²C Clock, I²C Data, +5 Vdc, Ground

Minimum cable clearance required at bottom of camera

90 mm





Order Today

Need more information? At Andor we are committed to finding the correct solution for you. With a dedicated team of technical advisors, we are able to offer you one-to-one guidance and technical support on all Andor products. For a full listing of our regional sales offices, please see: andor.com/contact

Our regional headquarters are:

EUROPE

Belfast, Northern Ireland
Phone +44 (28) 9023 7126
Fax +44 (28) 9031 0792

JAPAN

Tokyo
Phone +81 (3) 6732 8968
Fax +81 (3) 6732 8939

NORTH AMERICA

Concord, MA, USA
Phone +1 (860) 290 9211
Fax +1 (860) 290 9566

CHINA

Beijing
Phone +86 (10) 5884 7900
Fax +86 (10) 5884 7901

Items shipped with your camera

- 1x 2 m BNC - SMB connection cable
- 1x 3 m USB 2.0 cable Type A to Type B
- 1x PS-40 power supply
- 1x PS-40 to camera cable
- 1x PS-29 power supply with mains cable
- 1x CD containing Andor user guides
- 1x Individual system performance booklet

Background image on front page: NGC 6514 (M20)
The Trifid Nebula courtesy of R. Jay GaBany
(www.cosmotography.com)

Footnotes: Specifications are subject to change without notice

1. Assembled in a state-of-the-art cleanroom facility, Andor's UltraVac™ vacuum process combines a permanent hermetic vacuum seal (no o-rings), with a stringent protocol to minimize outgassing, including use of proprietary material.
2. This integrated shutter can be removed on request, and the camera configured to trigger an external shutter via TTL output.
3. Figures are typical unless otherwise stated.
4. Edge pixels may exhibit a partial response.
5. Specified minimum air cooled temperature assumes ambient temperature of 25°C. Specified minimum temperature with coolant assumes coolant temperature of 10°C.
6. Dark current measurement is taken as a median over the sensor area excluding any regions of blemishes.
7. Readout noise is for the entire system. It is a combination of sensor readout noise and A/D noise. Measurement is for Single Pixel readout with the sensor at a temperature of -80°C and minimum exposure time under dark conditions.
8. Linearity is measured from a plot of counts vs exposure time under constant photon flux up to the saturation point of the system.
9. The frame rates shown are for a range of binning or array size combinations. All measurements are made with 38 μs vertical shift speed. It also assumes internal trigger mode of operation and minimum exposure time.
10. 5 MHz is for focusing/visualization mode only.
11. Quantum efficiency of the sensor at 25°C as supplied by the sensor manufacturer.

Minimum Computer Requirements:

- 3.0 GHz single core or 2.4 GHz multi core processor
- 2 GB RAM
- 100 MB free hard disc to install software (at least 1GB recommended for data spooling)
- USB 2.0 High Speed Host Controller capable of sustained rate of 40MB/s
- Windows (8, 8.1 and 10) or Linux

Operating & Storage Conditions

- Operating Temperature: 0°C to 30°C ambient
- Relative Humidity: < 70% (non-condensing)
- Storage Temperature: -25°C to 50°C

Power Requirements

- 100 - 240 VAC, 50 - 60 Hz
- Power consumption: 4 stage cooler (W) 60W max.,
5 stage cooler (Z) 120W max

