

Spindle ball bearings (HY)* SM 61916 C

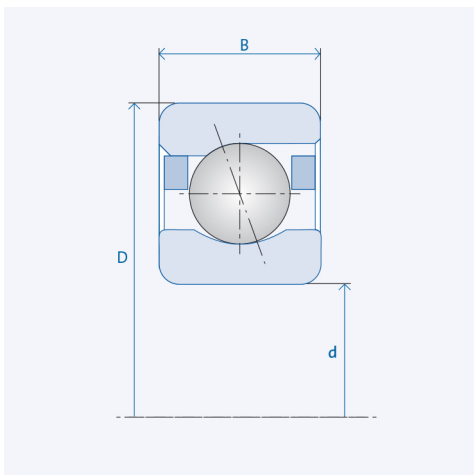

Precision class P4 / ABEC7

Components

Bearing designation:	(HY)* SM 61916 C
Bearing design:	SM
Series / size:	61916
Ball material:	Steel 100Cr6
Ball material HY :	Ceramic Si3N4
Cage:	TA (TXM available upon request)
Precision:	P4 (HG, UP, P2 upon request)
Main dimensions [d x D x B]:	80 x 110 x 16 mm

Technical data (Standard bearings)

Static load capacity C_0 :	20100
Dynamic load capacity C:	25500
Speed limit n_{Fett} :	15750
Speed limit n_{Oj} :	21000

Technical data (Hybrid bearings)*

Static load capacity C_{0HY} :	14200
Dynamic load capacity C_{HY} :	25500
Speed limit n_{Fett} :	19687.5
Speed limit n_{Oj} :	26250

Pre-tension

Light (L):	130 N
Axial rigidity (C_{ax}):	88 N/ μ m
Medium (M):	390 N
Axial rigidity (C_{ax}):	133 N/ μ m
Heavy (S):	780 N
Axial rigidity (C_{ax}):	175 N/ μ m
Spring preload (Ff):	970 N

The given speed limits apply to individual bearings with spring preload. Correction factors must be considered for all properties which deviate from this.

* All ball bearings are also available as hybrid ball bearings (HY).