

Spindle ball bearings (HY)* KH 6009 E

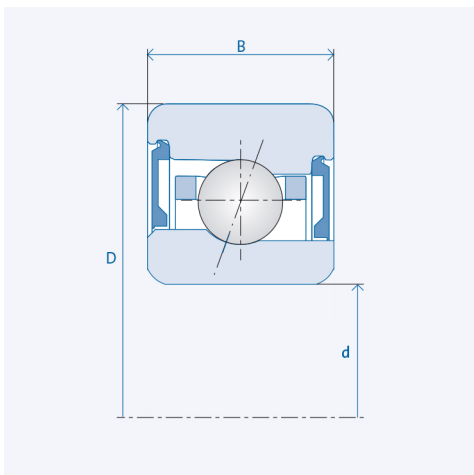

Precision class P4 / ABEC7

Components

Bearing designation:	(HY)* KH 6009 E
Bearing design:	KH
Series / size:	6009
Ball material:	Steel 100Cr6
Ball material HY :	Ceramic Si3N4
Cage:	TA (TXM available upon request)
Seal:	2RZ upon request
Precision:	P4 (HG, UP, P2 upon request)
Main dimensions [d x D x B]:	45 x 75 x 16 mm

Technical data (Standard bearings)

Static load capacity C_0 :	6650
Dynamic load capacity C:	10300
Speed limit n_{Fett} :	24000
Speed limit n_{Oj} :	32000

Technical data (Hybrid bearings)*

Static load capacity C_{0HY} :	4700
Dynamic load capacity C_{HY} :	10300
Speed limit n_{Fett} :	30000
Speed limit n_{Oj} :	40000

Pre-tension

Light (L):	90 N
Axial rigidity (C_{ax}):	92 N/ μ m
Medium (M):	260 N
Axial rigidity (C_{ax}):	135 N/ μ m
Heavy (S):	520 N
Axial rigidity (C_{ax}):	175 N/ μ m
Spring preload (Ff):	490 N

The given speed limits apply to individual bearings with spring preload. Correction factors must be considered for all properties which deviate from this.

* All ball bearings are also available as hybrid ball bearings (HY).