



Data Sheet *HISbasic*

HIS550R-AA

TO-39/TO-5 Thermal Infrared Emitter

HIS550R-AA

Thermal infrared emitter with sapphire window and Argon gas filling

Our HIS550R-AA is a NiCr filament based thermal emitter in a TO39 package, with a soldered sapphire window. This guarantees hermetically sealed package and long-term stability. The cap with the soldered sapphire window is tested with Helium leak test at $< 10^{-8}$ mbar l/s. The Argon gas filling with its higher thermal resistance compared to air or nitrogen provides a higher optical output power at the same electrical input power.

HISbasic series emitters have an integrated gold plated reflector that directs the radiation emitted from the rear to the front in order to achieve maximum efficiency. All our emitters offer minimum drift at constant resistance (Ohm). Infrasilids IR emitters are characterized by a very low temperature coefficient of electrical resistance. Therefore the hot resistance and the cold resistance are almost identical which eases the electrical control of the IR sources.

Key features

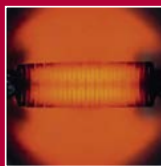

High radiant power

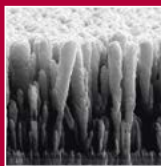

High efficiency



Hermetically sealed

- ✓ Pulsable thermal black-body infrared source mounted in an industry standard TO-39/TO-5 package.
- ✓ Patented nanostructured radiating element achieves up to 500% more detection signal!
- ✓ Lower radiating element temperature of 600 °C increases lifetime!
- ✓ Wide wavelength range enables a broad range of applications.

*innovative infrared sources for
gas detection & spectroscopy*

Main specifications

Parameter	HIS550R-AA
Package	TO-39 / TO-5
Radiating element area	11 mm ²
Radiating element emissivity	> 0.9
Radiating element temperature	600 °C at 600 mW
Optical output power	up to 140 mW
Max. electrical power (DC)	630 mW
Max. electrical voltage	3.7 V
Max. electrical current	170 mA
Electrical resistance	21...23 Ω
Modulation frequency*	4 Hz
Filter (soldered window)	Sapphire
Wavelength range	2 to 6 μm
Filling gas	Argon

* 50 % modulation depth, square wave signal, 50 % duty cycle

Optical specifications

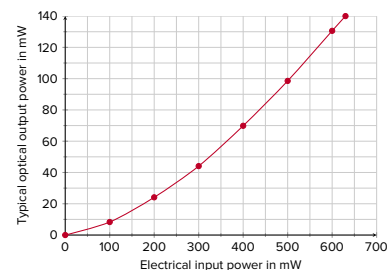
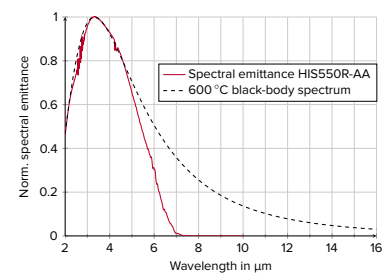

Radiating element temperature

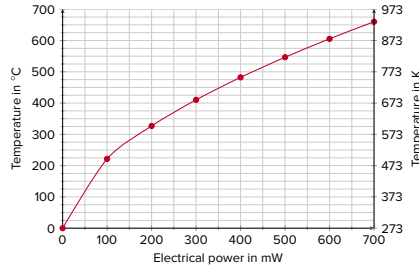

Modulation depth

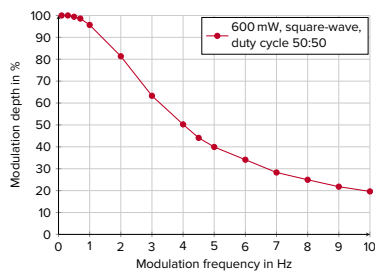

Electrical specifications

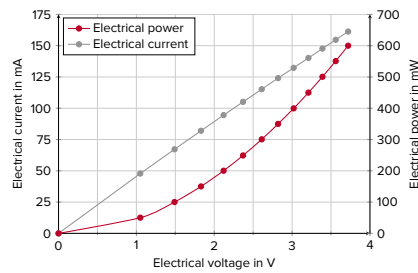

Window material transmissivity

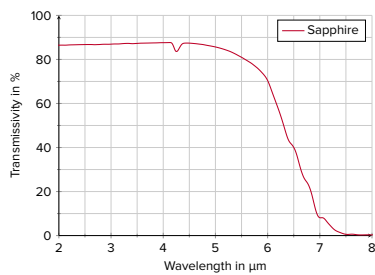

HIS550R-AA

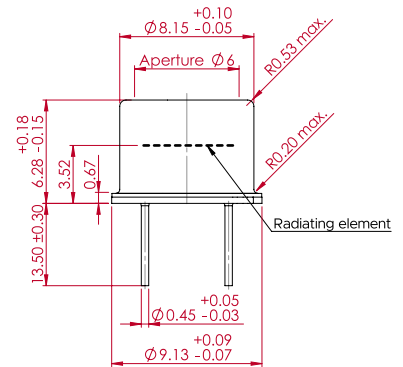
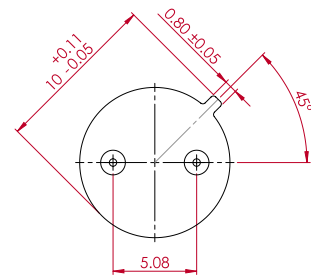

Angular radiation distribution

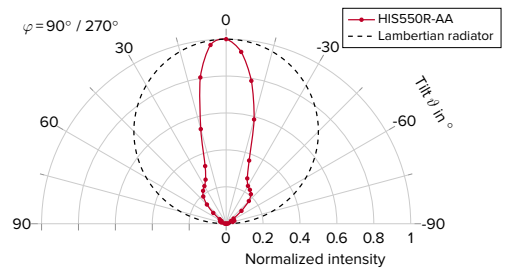
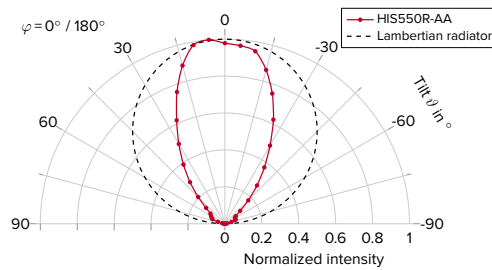
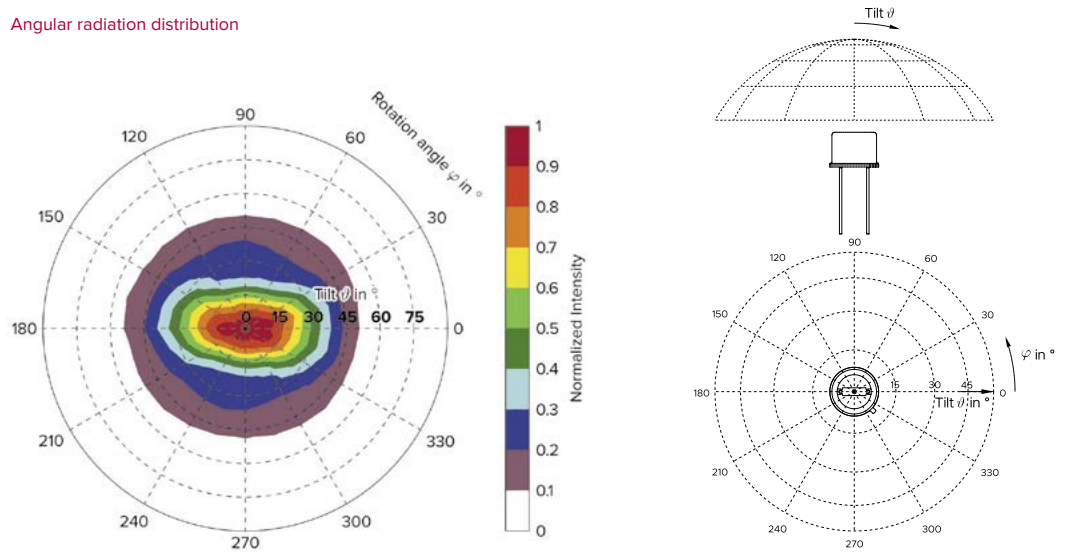

Operating mode recommendation:

All our IR sources can be driven in electrical voltage, current or power regulated mode. The application decides whether the operating mode is DC or AC (pulsed). Depending on the drive mode and the applied electrical power the electrical resistance of the IR emitter can change over time. For highest measurement accuracy a power regulated mode is always recommended for thermal IR emitters. However, it is the most complex operating mode and not suitable in all applications.

For applications that require a small and low-cost driving circuit with a maximum stability we have a technical note with an adjustable low dropout voltage (LDO) regulator.

For further information please refer to: www.infrasilid.com/technicalnote