

## X-LRQ-DEC Series Datasheet



- 75, 150, 300, 450, 600 mm travel
- Up to 13  $\mu\text{m}$  accuracy over 600 mm travel
- 100 kg load capacity
- Up to 205 mm/s speed and up to 300 N thrust
- Built-in controller; daisy-chains with other Zaber products
- Integrated linear encoders with 50 nm resolution provide slip/stall detection and position correction
- Inline and parallel drive configurations
- Ball screw and lead screw configurations
- Includes stainless steel dust cover
- Custom versions available

## X-LRQ-DEC Series Overview

Zaber's X-LRQ-DEC Series devices are computer-controlled, motorized linear stages with high stiffness, load, and lifetime capabilities in a compact size. An integrated linear encoder combined with stage calibration provides high accuracy positioning over the full travel of the device. Each device is available in either an inline or parallel drive configuration. A flexible stainless steel dust cover prevents the ingress of small objects. They are stand-alone units requiring only a standard 24 V or 48 V power supply. An optional indexed knob provides convenient manual control for versatile operation even without a computer.

These stages connect to the RS-232 port or USB port of any computer, and they can be daisy-chained with any other Zaber products. The daisy-chain also shares power, making it possible for multiple X-Series products to share a single power supply. Convenient locking, 4-pin, M8 connectors on the unit allow for secure connection between units.

At only 48 mm high, these stages are excellent for applications where a low profile is required. The X-LRQ-DEC's innovative design allows speeds up to 205 mm/s and loads up to 100 kg. Like all of Zaber's products, the X-LRQ-DEC Series is designed to be 'plug and play' and very easy to set up and operate. These stages can bolt together into XY and XYZ systems. Some multi axis configurations may require additional accessories, please contact Zaber Technical Support to ensure the correct ones are selected.

For more information visit: <https://www.zaber.com/products/linear-stages/X-LRQ-DEC/6>

## X-LRQ-DEC Series Part Numbering

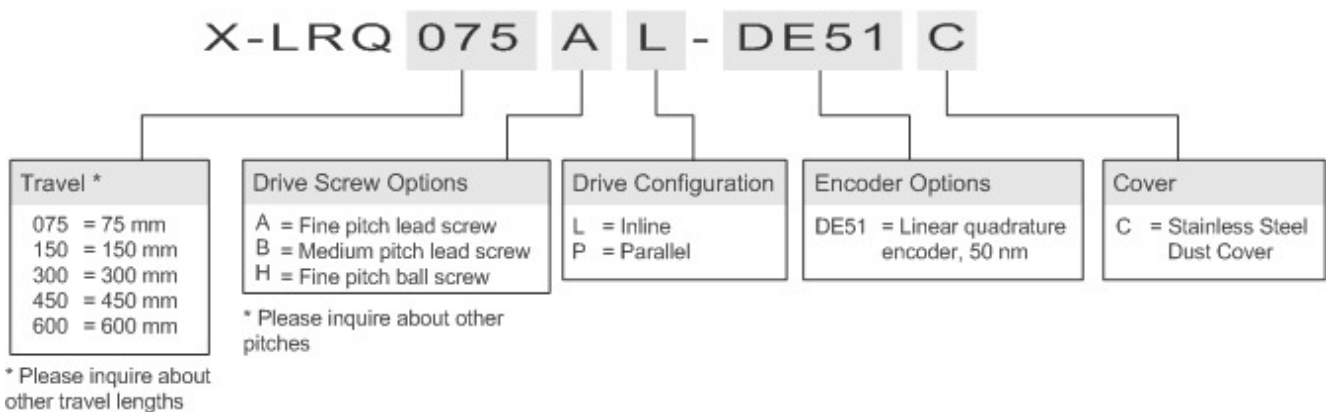

X-LRQ-DEC Series Drawings

## X-LRQ-DEC Series Specifications

Specification	Value	Alternate Unit
Microstep Size (Default Resolution)	0.1953125 $\mu\text{m}$	
Built-in Controller	Yes	
Travel Range	450 mm	17.716"
Accuracy (unidirectional)	15 $\mu\text{m}$	0.000591"
Repeatability	< 3 $\mu\text{m}$	< 0.000118"
Backlash	< 11 $\mu\text{m}$	< 0.000433"
Maximum Speed	100 mm/s	3.937"/s
Minimum Speed	0.000119 mm/s	0.000005"/s
Speed Resolution	0.000119 mm/s	0.000005"/s
Encoder Type	Linear quadrature encoder	
Encoder Resolution	50 nm	
Peak Thrust	300 N	67.3 lb
Back-driving Force	106 N ( $\pm 30\%$ )	23.8 lb ( $\pm 30\%$ )
Maximum Continuous Thrust	200 N	44.9 lb
Communication Interface	RS-232	
Communication Protocol	Zaber ASCII (Default), Zaber Binary	
Maximum Centered Load	1000 N	224.3 lb
Maximum Cantilever Load	3000 N-cm	4248.4 oz-in
Guide Type	Recirculating Ball Linear Guide	
Vertical Runout	< 45 $\mu\text{m}$	< 0.001772"
Horizontal Runout	< 40 $\mu\text{m}$	< 0.001575"
Pitch	0.04°	0.698 mrad
Roll	0.025°	0.436 mrad
Yaw	0.04°	0.698 mrad
Stiffness in Pitch	640 N-m/°	27 $\mu\text{rad/N-m}$
Stiffness in Roll	1850 N-m/°	9 $\mu\text{rad/N-m}$
Stiffness in Yaw	665 N-m/°	26 $\mu\text{rad/N-m}$
Maximum Current Draw	1200 mA	
Power Supply	24-48 VDC	
Power Plug	2-pin screw terminal	

<b>Specification</b>	<b>Value</b>	<b>Alternate Unit</b>
Linear Motion Per Motor Rev	2.5 mm	0.098"
Motor Steps Per Rev	200	
Motor Type	Stepper (2 phase)	
Motor Rated Current	2300 mA/phase	
Inductance	2.8 mH/phase	
Default Resolution	1/64 of a step	
Data Cable Connection	Locking 4-pin M8	
Mechanical Drive System	Precision ball screw	
Limit or Home Sensing	Magnetic home sensor	
Manual Control	Indexed knob with push switch	
Axes of Motion	1	
LED Indicators	Yes	
Mounting Interface	M6 and M3 threaded holes	
Operating Temperature Range	0 to 50 °C	
Vacuum Compatible	No	
RoHS Compliant	Yes	
CE Compliant	Yes	
Weight	4.61 kg	10.163 lb

X-LRQ-DEC Series Charts

Thrust Speed Performance

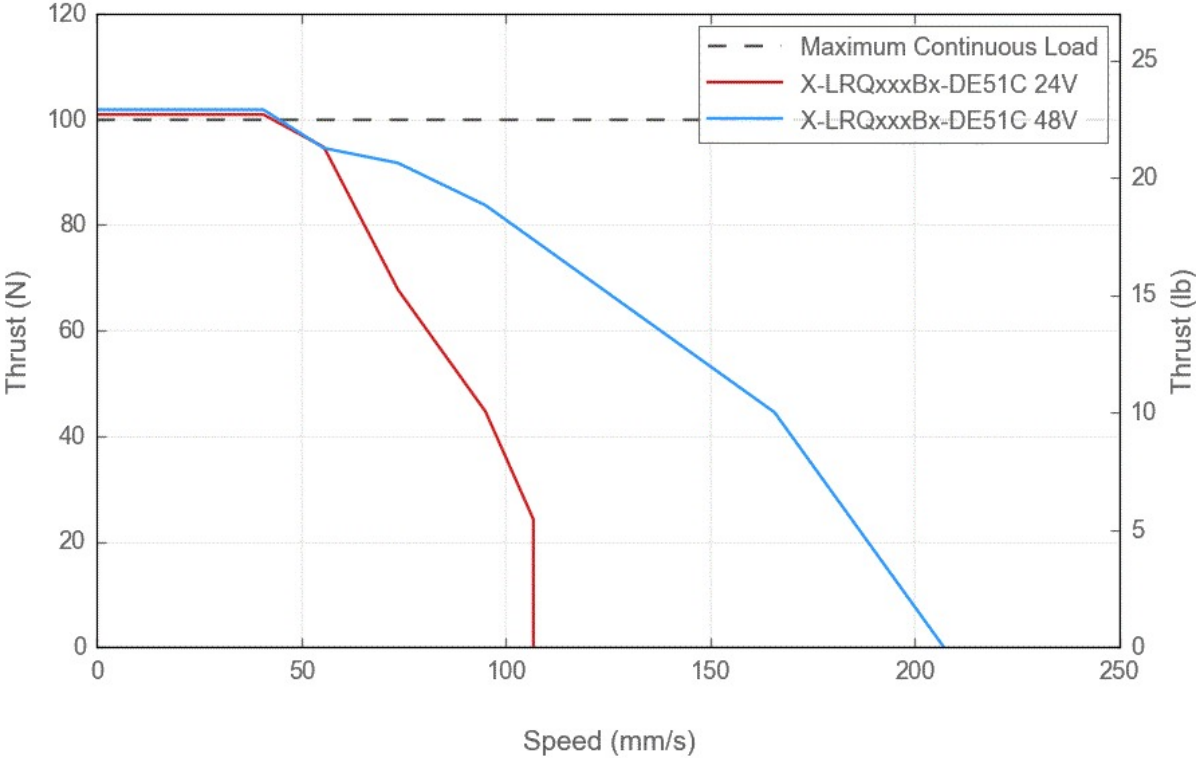

### Thrust Speed Performance

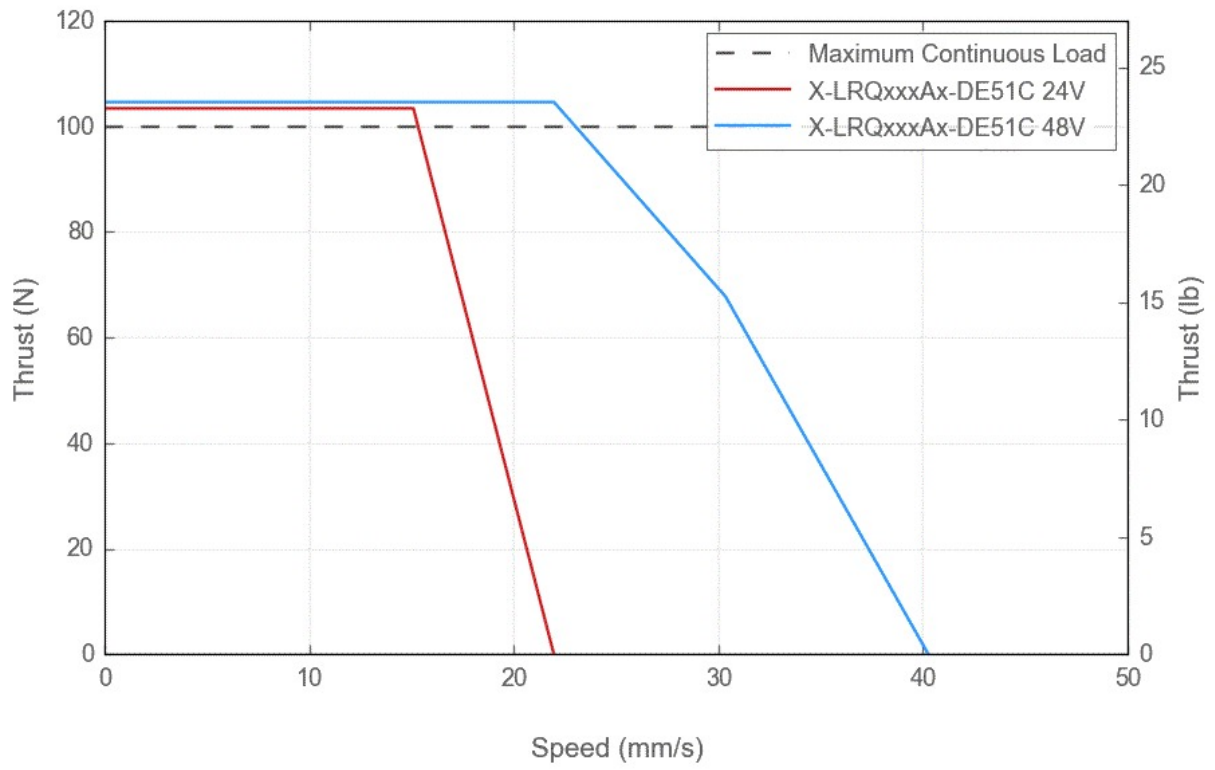

## Thrust Speed Performance

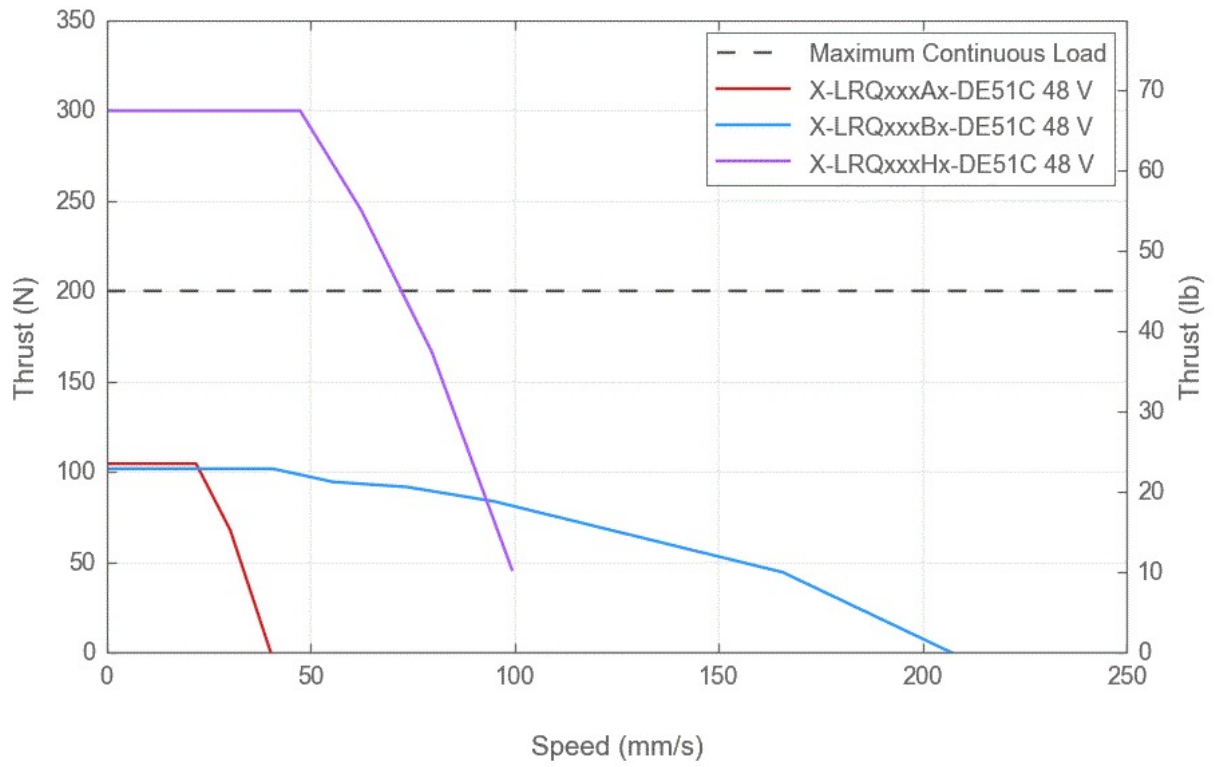



## Thrust Speed Performance

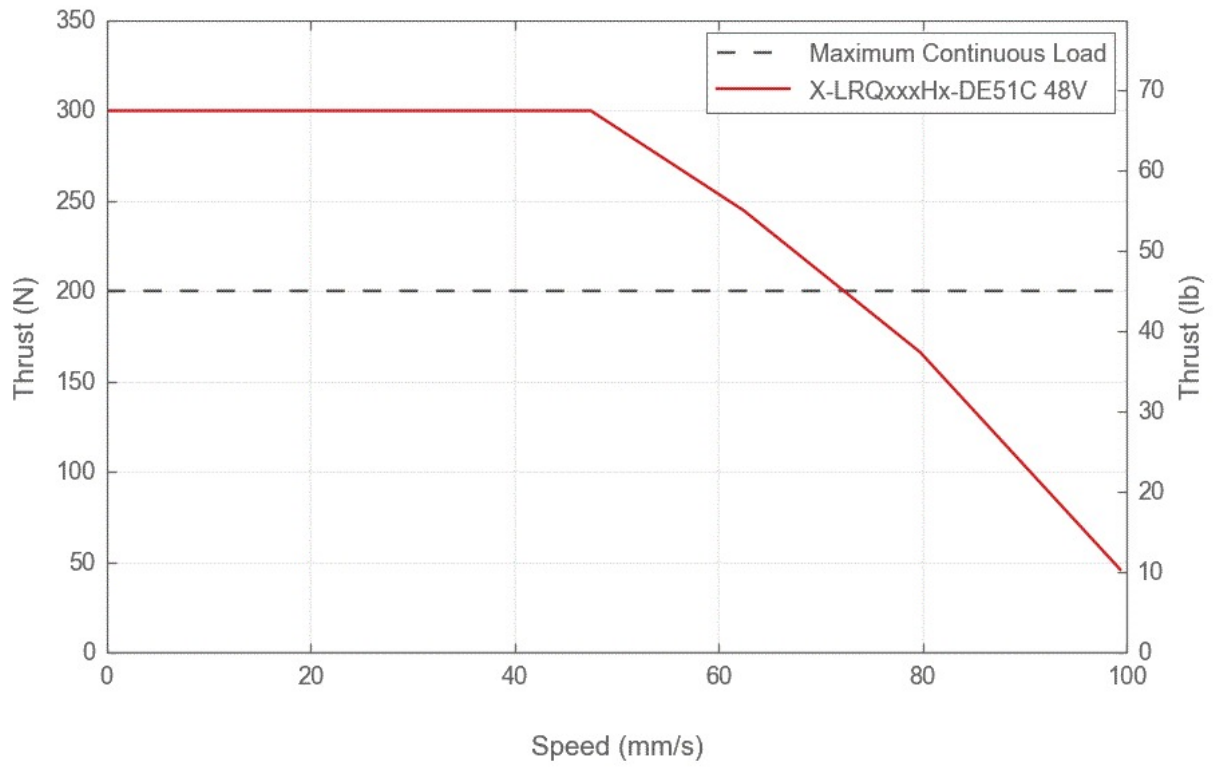

### Typical Accuracy

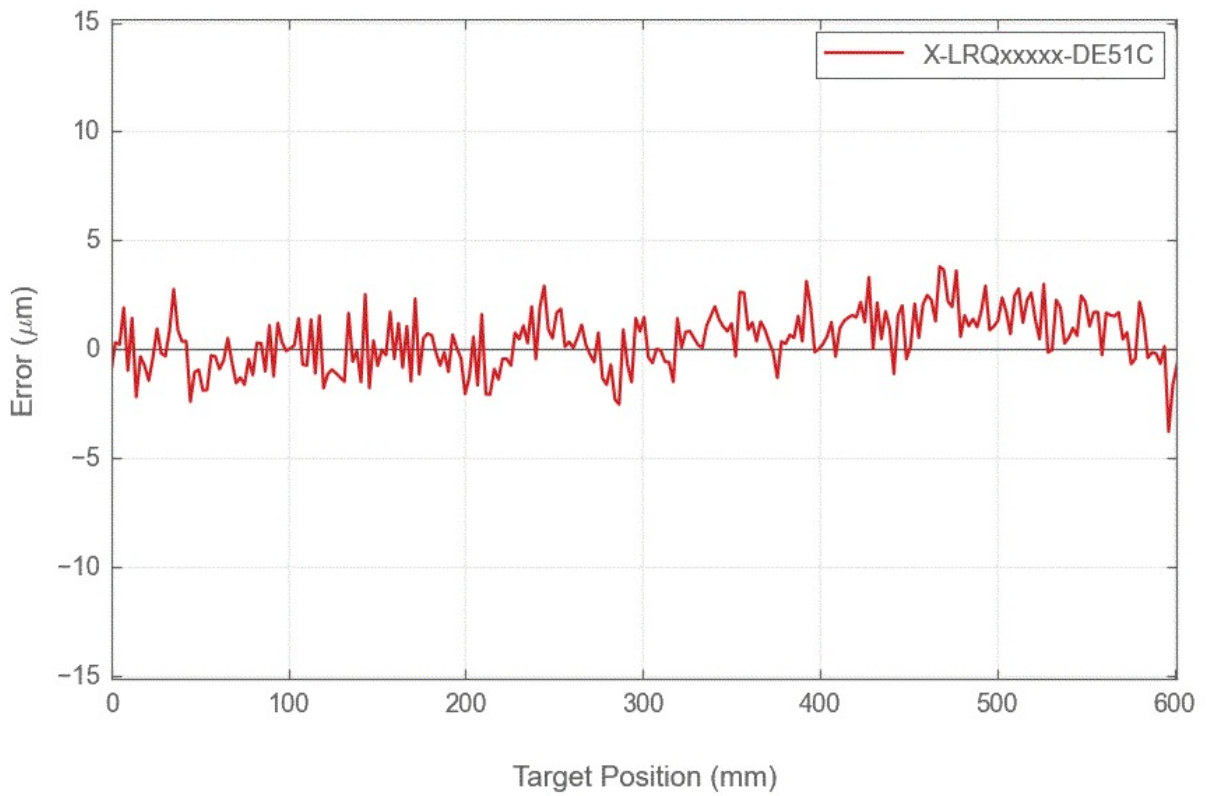

### LRQ Linear Bearing Lifetime

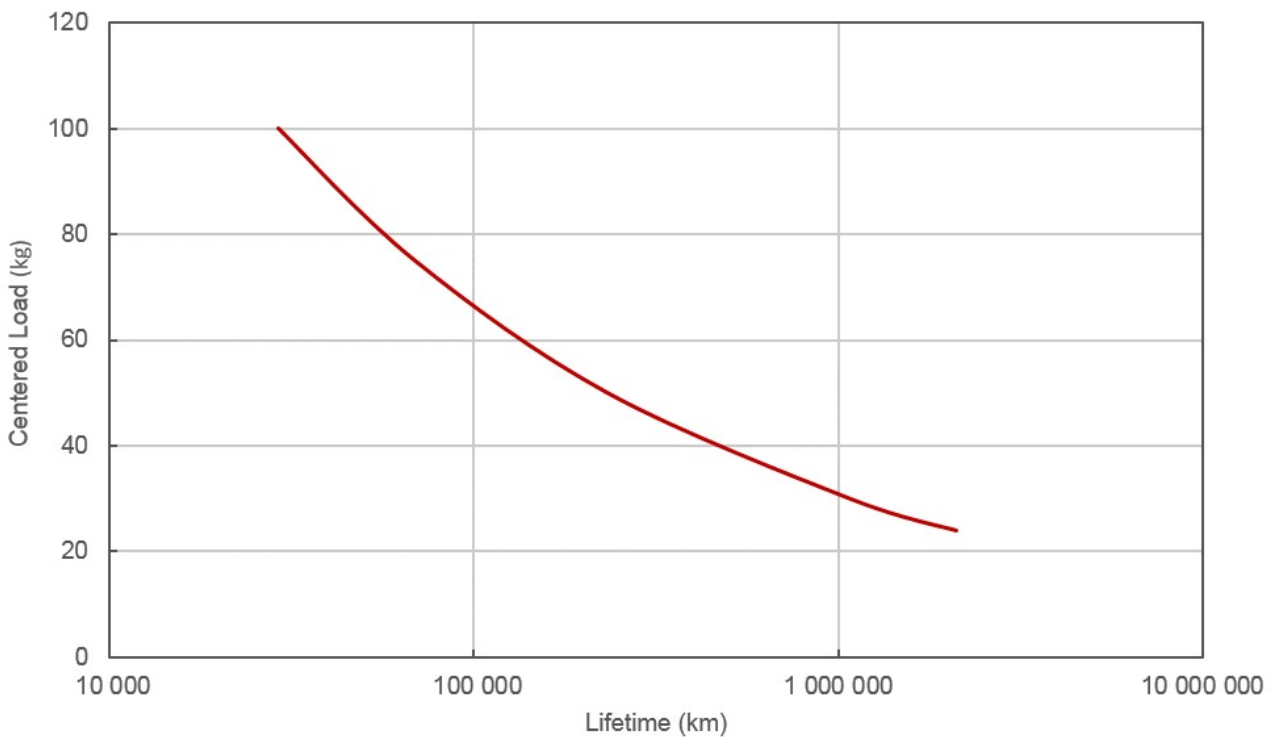

## Contact

Email: [contact@zaber.com](mailto:contact@zaber.com)

Phone (toll free Canada/USA): 1-888-276-8033

Phone (direct): 1-604-569-3780

Fax: 1-604-648-8033

Zaber Technologies Inc.

#2 - 605 West Kent Ave. N.

Vancouver, British Columbia

Canada, V6P 6T7

<https://www.zaber.com>