



Electronic room humidistat

2 relay contacts humidity

eStat10

Electronic room hygro-thermostat

2 relay contacts humidity + temperature

eStat10 DUO

- 2 potential-free switching outputs configurable as openers or closers
- 2 independently configurable setpoints and switching hysteresis
- 2 continuous 0...10 V signal outputs for relative humidity and temperature
- Easy to install
- Display of current relay switching states
- Alternating display of relative humidity and temperature
- Temperature compensation

Technical Data

Humidity

Measuring range	0 ... 100 %RH
Control range	5 ... 95 %RH
Setting range of switching hysteresis	0.5 ... 9 %RH
Measuring uncertainty	
10 ... 90 %RH at 25 °C max.	≤ ± 3 %RH
0 ... 10 %RH and 90 ... 100 %RH ref. to 25 °C additional	≤ ± 0,2 %RH / %RH
Long term stability	≤ 0.5 %RH/a
Hysteresis	≤ 1 %RH
Typ. temperature influence at 25 °C	± 0.05 %RH/K

Electrical data

Switching outputs	2 relay contacts potential-free, normally open
Setting as opener / closer	Via DIP switch
Switching voltage	≤ 48 V DC/AC ≥ 100 μV
Breaking capacity	≤ 60 W / 62.5 VA
Power factor	≥ 0.9
Switching cycles (at Pmax)	> 100.000
Switching current	≤ 2 A
Continuous output rel. humidity	0 ... 10 V DC
Continuous output temperature	0 ... 10 V DC
Supply voltage	15 ... 30 V DC 13 ... 26 V AC
Consumption	≤ 30 mA

Temperature

Output ranges	0 ... +50 °C
further ranges on request	-30 ... +70 °C 0 ... +100 °C
Measuring uncertainty at 23 °C and ≤ 250 mA switching current	typ. ± 0.3 K
DUO: Control range	-25 ... +55 °C
DUO: Setting range switching hysteresis	0.1 ... 10 K

General data

Measuring medium	Air, non-pressurised, non-condensing, non-aggressive
Operating temperature	- 30 ... + 60 °C
Storage temperature	- 40 ... + 85 °C
Electrical connections at mains terminals	
Wire cross-section at each connection	max. 1.5 mm ²
Cable diameter	
▶ Surface-mounted cable	max. 1 x ø 6.5 mm or 2 x ø 4.5 mm
▶ Concealed cable	See: User instructions on page 5
Housing IP rating	IP 30D
Safety category	III
Housing materials	ABS
Housing colour	Similar to RAL 9003 Signal white
Display	2 lines
Applied directives / Standard	EMC directive 2014/30/EU DIN EN 61326-2-3 DIN EN 61326-1

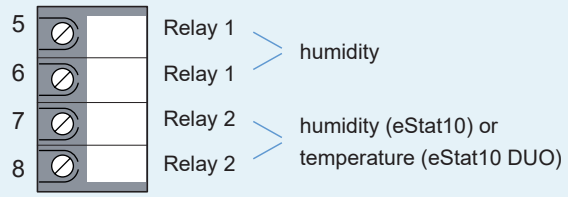
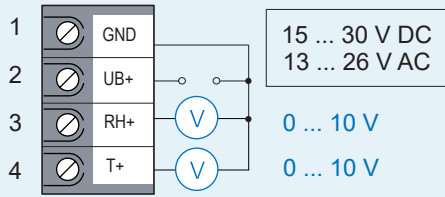

Relay outputs: potential free, normally open

ESD protection advice

The devices contain components which can be damaged by the effects of electrical fields or by charge equalisation when touched.



The following protective measures must be taken when the housing of the device is to be opened for connection:

- Before opening the housing, ensure electrical potential equalisation between you and your environment.
- Pay particular attention to ensure that this potential equalisation is maintained while you are working with the housing open.

Dimensions

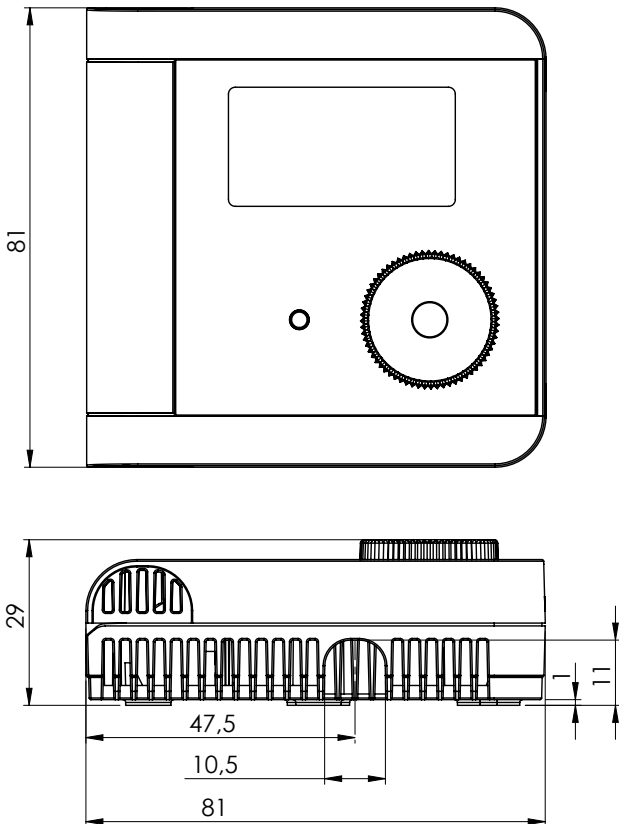

Drilling pattern

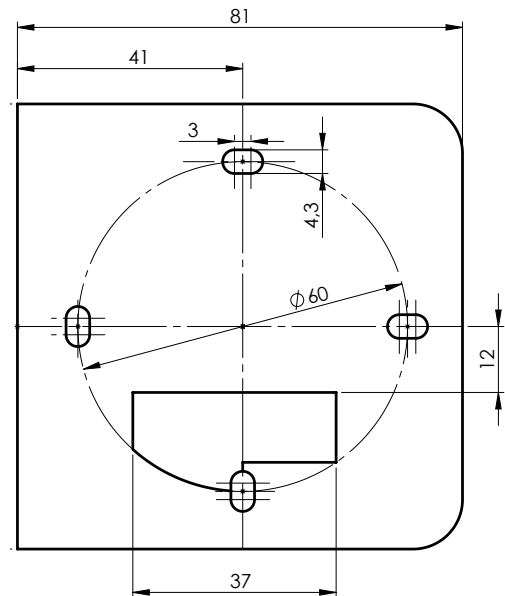

Opening the housing

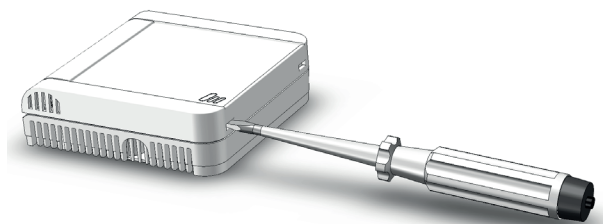

Configuration guide

Operation mode

In standard operation, the display alternates between %RH and °C.

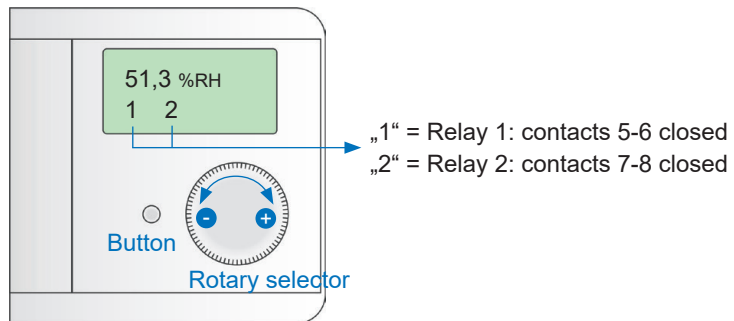

- 1 Switch to configuration mode:
Press button briefly

Configuration Relay 1

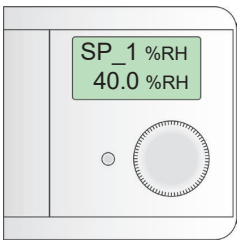

- 2 **Setpoint 1** for Relay 1 adjustable with rotary selector
Press the button
> 3 seconds = Stor ✓
Store (setting has been applied)
< 3 seconds = _ESC ✗
Cancel without saving

- 3 Switch to next parameter:
Press button briefly

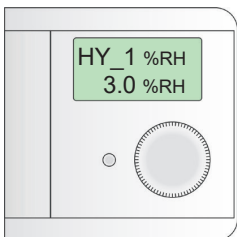

- 4 **Switching hysteresis 1** for setpoint 1 adjustable with rotary selector
Press the button
> 3 seconds = Stor ✓
Store (setting has been applied)
< 3 seconds = _ESC ✗
Cancel without saving

- 5 Switch to next parameter:
Press button briefly

Configuration Relay 2

- eStat10 relay 2: relative humidity (%RH)
- eStat10 DUO relay 2: temperature (°C)

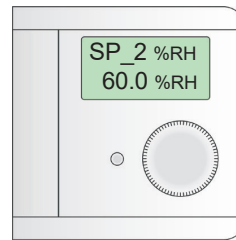

- 6 **Setpoint 2** for Relay 2 adjustable with rotary selector
Press the button
> 3 seconds = Stor ✓
Store (setting has been applied)
< 3 seconds = _ESC ✗
Cancel without saving

- 7 Switch to next parameter:
Press button briefly

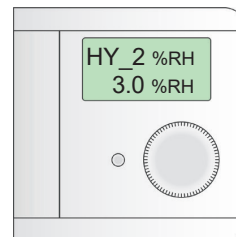

- 8 **Switching hysteresis 2** for setpoint 2 adjustable with rotary selector
Press the button
> 3 seconds = Stor ✓
Store (setting has been applied)
< 3 seconds = _ESC ✗
Cancel without saving

- 9 Switch to operation mode:
Press button briefly

Operation mode

In standard operation, the display alternates between %RH and °C.

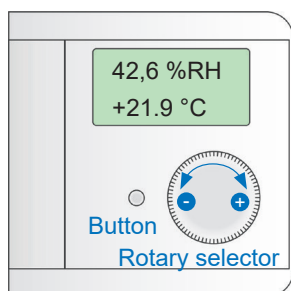

The factory setting for keylock is inactive (**Coff**). The keylock can be switched on and off with the access code 1385.

Enter access code 1385

The access code is preset and cannot be changed!

- 1 Press button longer than > 3 seconds
Code 0.000 appears.

The first digit is now "active". With the rotary controller, each individual digit can be changed in the range 0 ... 9.

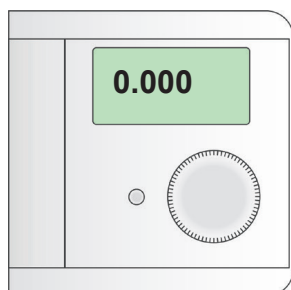

- 2 Press and release the button to move to the next digit.

1st digit "active"	0.000
2nd digit "active"	10.00
3rd digit "active"	130.0
4th digit "active"	1380

Exception: No decimal point to the bottom right of the 4th digit.

Verify access code

- 3 After entering the complete access code, press button for longer than 3 seconds.

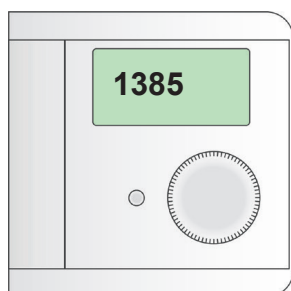

The access code is verified:

- ✓ the currently stored status appears. (Coff oder C_on).
- ✗ **_ESC** = Stop/Exit appears if the access code wasn't entered correctly.

Keylock settings

- 4 Choose the required setting by turning the rotary selector.

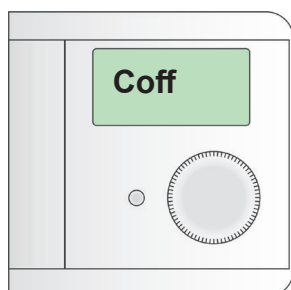

- a.) **Coff** = Code off/ keylock inactive (factory setting).
- b.) **C_on** = Code on/ keylock active.

Store or Stop

- 5 Press button...
 - ✓ > 3 seconds
Stor = Store setting has been applied
 - ✗ < 3 seconds
_ESC = Cancel without saving



- 6 The hygro-thermostat switches to operation mode. Depending on keylock settings, the setting points are...

- **Coff** = configurable (see P. 3)
- **C_on** = non configurable

Setting relay 1 and 2 as opener or closer

DIP-Switch	Current	reading
set to	$< \text{setpoint} - \frac{\text{switching hysteresis}}{2}$	$> \text{setpoint} + \frac{\text{switching hysteresis}}{2}$
C (Closer)	Relay = open	Relay = closed
O (Opener)	Relay = closed	Relay = open

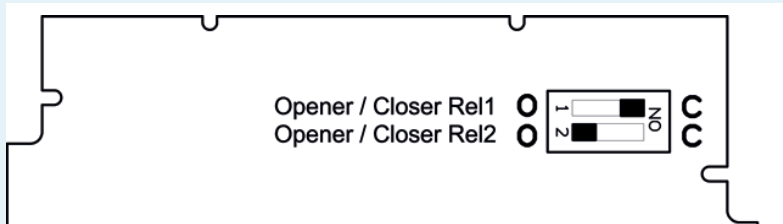

Installation instructions

Position	The installation site should be chosen such that a representative measurement of air humidity can be guaranteed, i.e. the humidity readings at the installation site should correspond to those in the room. Avoid areas in the vicinity of radiators, doors and exterior walls, as well as direct sunlight.
Flush mounting	When flush-mounting the device, appropriate seals should be used to prevent external air from reaching the sensor element of the device through the concealed housing.
Connection to surface-mounted and concealed cables	When connecting to a concealed cable, the knock-out part of the housing floor should be broken out to allow the cable to pass through. When connecting to a surface-mounted cable, the separators at the hollowed-out points in the side of the housing can be broken out.
Connection	The device must be connected by qualified personnel. The housing contains sensitive components. When opening the housing, electrostatic discharge (ESD) precautions must be observed. Leads connected to the sensor must not run parallel to strong electromagnetic fields. Where there is a possibility of voltage surges, install surge protection devices.

User instructions

Damaging influences	Depending on their type and concentration, aggressive media containing solvents can cause incorrect readings or cause the sensor to fail. Substances deposited on the sensor element (e. g. resin aerosols, paint aerosols, smoke deposits etc.) are harmful as they eventually form a water-repellent film.
----------------------------	---



This information is based on current knowledge and is intended to provide details of our products and their possible applications. It does not, therefore, act as a guarantee of specific properties of the products described or of their suitability for a particular application. In our experience, the equipment may be used across a broad spectrum of applications under the most varied conditions and loads. We cannot assess every individual case. Purchasers and/or users are responsible for checking the equipment for suitability for specific applications. Any existing industrial rights of protection must be observed. The quality of our products is guaranteed under our General Conditions of Sale. Datasheet eStat10(DUO). Issue: February 2020. Subject to modifications.

