

VAF

INSTRUMENTS



MidFlow[®] / HiFlow[®]

Sliding Vane Meters DN 25-300 (1"-12")

127

Product Bulletin

TO BE
REALLY
SURE

Introduction

VAF Instruments MidFlow®/HiFlow® positive displacement type liquid flowmeters are used in continuous metering applications, in-line blending processes and batch applications. MidFlow®/HiFlow® flowmeters have a simple, rugged design. With only few almost frictionless moving internal parts there is hardly any wear in the flowmeter which safeguards a typical long lasting lifetime. MidFlow®/HiFlow® meters have no mechanical seals saving you from regular maintenance and possible leakage of process liquids into the environment. The flowmeter is driven by the process liquid which makes it suitable for distant locations without power supply. The high accuracy of the flowmeter (better than 0.1% and repeatability 0.05%) is not influenced by process pressure or temperature, mechanical pipe strain or liquid turbulence and therefore straight inlet and outlet pipe pieces are not required.

Experience in flow measurement

In 1938 VAF Instruments started as a manufacturer of petrol delivery pumps. The flowmeters made by VAF for this pump already had to have the highest accuracy and had to meet the demands of the board of weights and measures. Innovation and research over the past 75 years helped VAF to make new types of flowmeters bearing in mind customer requirements and the need for accurate flow measurement.

VAF Instruments flowmeters are available in sizes from 8 mm up to 300 mm (1 l/hr up to 960 m³/hr). MidFlow®/HiFlow® flowmeters cover the middle and high part of this range.

Available MidFlow®/HiFlow® meters

MidFlow®/HiFlow® flowmeters are available in connection sizes from 25 mm up to 300 mm representing maximum flow ranges from 160 l/min up to 16000 l/min. A choice of material is available with ductile iron, steel and stainless steel. For registration of the measured amount of liquid, VAF MidFlow®/HiFlow® meters can be fitted with various combinations of counters and pulse transmitters.

Liquids

VAF positive displacement flowmeters series MidFlow®/HiFlow® are suitable for a wide range of liquids. Because liquids with higher viscosities do not degrade the accuracy of the sliding vane flowmeter, it is possible to use only one flowmeter for various liquids.

MidFlow®/HiFlow® meters are used for acids, alkalines, cleansing liquids, solvents, water, edible oils and fats, liquor, glucose, paint, all petrochemical liquids from LPG to bitumen, alcohol, printing ink, glue and many other organic and inorganic liquids.

Special versions

This brochure comprises only VAF Instruments' standard delivery program. Special flowmeter variants can be offered as tailor-made solutions.

Consult VAF Instruments for further information.

MidFlow®/HiFlow® are registered trade marks of VAF Instruments B.V.

Principle of operation

VAF Instruments positive displacement flowmeters operate on the sliding vane principle. The meter consists of a specially shaped housing in which a rotor can rotate freely.

Two pairs of vanes are placed into four slots in the rotor. Each pair is positioned by a rod and can move in and out of the rotor. The radial movement of the vanes is guided by the special inner shape of the housing. This patented construction provides a constant seal between the inlet and the outlet of the meter. The incoming liquid forces the rotor to rotate. The rotation of the rotor is transferred via a magnetic coupling to a read out device. This can be a counter in any desired engineering unit or a pulse transmitter for remote read out, flow data processing or connection to a process computer.

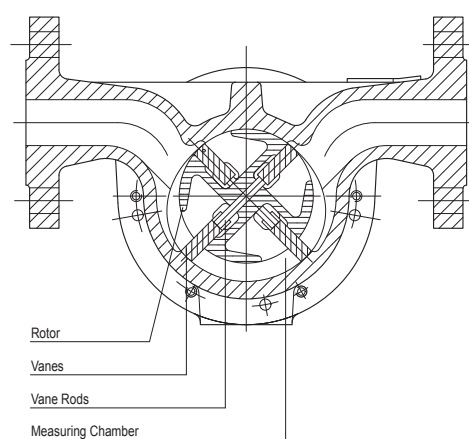

Fig. 1 Sectional view

Features & benefits

Features	Benefits
High capacity and rangeability	One meter for a wide range of flows
	Lower investment
High accuracy	Exact registration of transferred amount of liquid
	No loss of valuable raw material
Design simplicity	Easy to service
	No complex replacement parts
	Low operation cost
Accuracy not degraded by: process pressure / process temperature / liquid viscosity / liquid conductivity / pipe strain / flow pattern (turbulence)	Easy to operate because no need for external settings saving time in operation and training
	One single meter model is suitable for different liquids resulting in a lower investment
	No straight pipe required before or behind meter thus less space required
Rugged design	Easy to integrate in compact systems
	Space saving
Certified by European Classification Authorities (MID - approval) for custody transfer applications	Calibration according standard procedures
Constructed to CE standards	Time saving
From ISO 9001 registered company	No special adjustments necessary
Few internal parts	Assured product quality
	Less wear
	Long lifetime
Measurement driven by liquid	Low operation cost
	No auxiliary power needed
	Suitable for many remote locations
Local and/or remote registration with standard counters and Ex pulse transmitters	Standard flowmeter suitable for hazardous areas



Fig. 2 MidFlow® meter

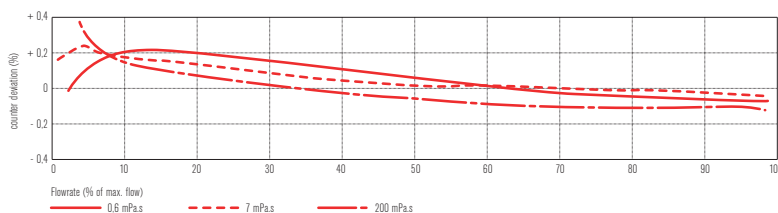

Fig. 3 MidFlow® meter

Technical specification

Typical calibration curves

VAF Instruments flowmeters perform liquid measurement with the highest accuracy. This graph shows typical calibration curves for liquids with different viscosities. Consult the factory for other values.



MidFlow[®]

Basic model number	J5025	J5040	J5050	J5080	J5100	J1025	J1040	J1050	J1080	J1100	J3025	J3040	J3050	J3080	J3100					
Connection size, DN [mm]	25	40	50	80	100	25	40	50	80	100	25	40	50	80	100					
Capacity [l/min]	see graphs																			
Maximum, 8 hrs/day discontinuous	160	250	500	1900	2750	160	250	500	1900	2750	160	250	500	1900	2750					
Maximum, continuous	120	190	380	1450	2000	120	190	380	1450	2000	120	190	380	1450	2000					
Minimum, range 1:10 ¹	16	25	50	190	275	16	25	50	190	275	16	25	50	190	275					
Minimum, range 1:20 ²	8	12.5	25	80	137.5	8	12.5	25	80	137.5	8	12.5	25	80	137.5					
Displaced volume per revolution [litre]	0.167	0.167	0.40	2.95	5.30	0.167	0.167	0.40	2.95	5.30	0.167	0.167	0.40	2.95	5.30					
Measuring accuracy																				
Range 1:10 ¹ better than	± 0.2 %			± 0.1 %			± 0.2 %			± 0.1 %			± 0.2 %			± 0.1 %				
Range 1:20 ² better than	± 0.3 %																			
Repeatability	better than ± 0.05 %																			
Required starting pressure [kPa (bar)]	3 (0.03)																			
Materials																				
Body	ductile iron					AISI 316														
Rotor	ductile iron			cast iron		ductile iron			cast iron		AISI 316									
Covers	ductile iron / steel on application					steel										AISI 316				
Vanes	carbon																			
O-rings	Vitron A / PFA covered Vitron A or Kalrez on application										PFA covered Vitron A / Kalrez on application									
Bearings	steel ball bearings / stainless steel ball bearings on application										AISI 316 needle bearings									
Body pressure rating [kPa (bar)]	2000 (20)			1050 (10.5)			2500 (25)			2000 (20)			2500 (25)			2000 (20)				
with steel covers	2500 (25)			2000 (20)			not applicable													
Available flanges																				
DIN PN [bar]	PN 10, 16, 25; raised face or with groove acc. DIN 2512N																			
ANSI	150, 300 RF ³																			
JIS [K]	5, 10, 16, 20																			
Liquid temperature range standard	-10 °C to 120 °C for other temperatures consult factory																			
Weight without counter [kg]	13	16	24	78	108	13	16	24	78	108	13	16	24	78	108					

Notes: ¹ standard factory calibration. ² calibration on request. ³ for 300 lbs flanges on 100 mm models consult factory.

Flow ranges

To select the appropriate meter size for your process the graphs must be used. The data in these graphs only refer to standard flowmeters used on Newtonian liquids. Consult VAF Instruments for viscosities higher than shown in the graphs. Lower minimum capacities are possible dependent on liquid viscosity and required measuring accuracy.

Flowrate - pressure drop viscosity relation

These graphs show the pressure drop across the flowmeter as a function of the flowrate and the viscosity of the liquid. The sloping lines are lines of equal viscosity. The curve at the top of the graphs represents the maximum allowable pressure drop.

HiFlow®

Basic model number	J5150	J5200	J5250	J5300	J1150	J1200	J3150	J3200
Connection size, DN [mm]	150	200	250	300	150	200	150	200
Capacity [l/min]	see graphs							
Maximum, 8 hrs/day discontinuous	4.600	8.000	12.500	16.000	4.600	8.000	4.600	8.000
Maximum, continuous	3.450	6.000	9.500	12.000	3.450	6.000	3.450	6.000
Minimum, range 1:10 ¹	460	800	1.250	1.600	460	800	460	800
Minimum, range 1:20 ²	230	400	625	800	230	400	230	400
Displaced volume per revolution [litre]	11,9	29,3	58,6		11,9	29,3	11,9	29,3
Measuring accuracy								
Range 1:10 ¹ better than	± 0,1 %							
Range 1:20 ² better than	± 0,3 %							
Repeatability	better than ± 0,05 %							
Required starting pressure [kPa (bar)]	3 (0,03)							
Materials								
Body	ductile iron				AISI 316			
Rotor	cast iron						AISI 316	
Covers	ductile iron				carbon steel		AISI 316	
Vanes	carbon							
O-rings	Viton A, PFA covered Viton A						PFA covered Viton A	
Bearings	steel						stainless steel	
Body pressure rating, [kPa (bar)]	1050 (10,5)	1250 (12,5)			Design on application			
Available flanges								
DIN PN [bar]	10, 16; optional with groove acc. DIN 2512N							
ANSI	150 RF							
JIS [K]	5, 10							
Liquid temperature range standard	-10 °C to 120 °C for other temperatures consult factory							
Weight without counter [kg]	215	585	1000	1100	230	605	320	500

¹ Standard factory calibration. ² Calibration on request.

Technical specification

Note

For liquids with viscosities below 0,5 mPa.s with poor lubricating properties, or flowmeters that are running continuously it is also advisable to reduce the maximum flow, to prevent excessive wear of the vanes. A general rule is to reduce the maximum capacity to 75% of the value specified in the table.

Lower minimum capacities are possible dependent on liquid viscosity and required measuring accuracy.

Consult VAF Instruments on application.

Note: 1 cSt = 1 mPa.s if specific gravity is 1,0

MidFlow[®]

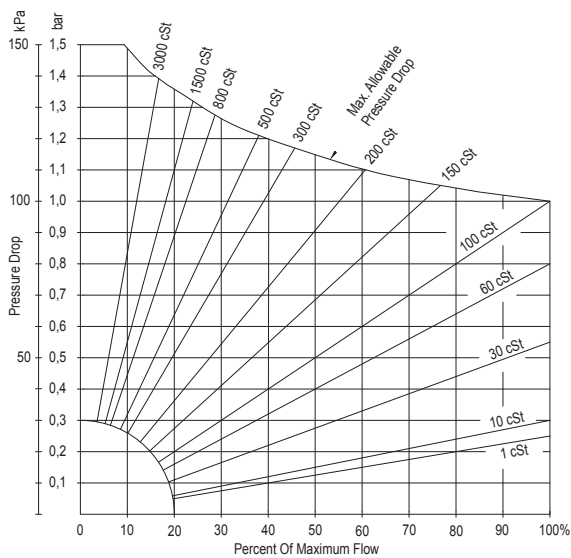

Meter size DN 25 mm: 100% = 160 l/min

Meter size DN 40 mm: 100% = 250 l/min

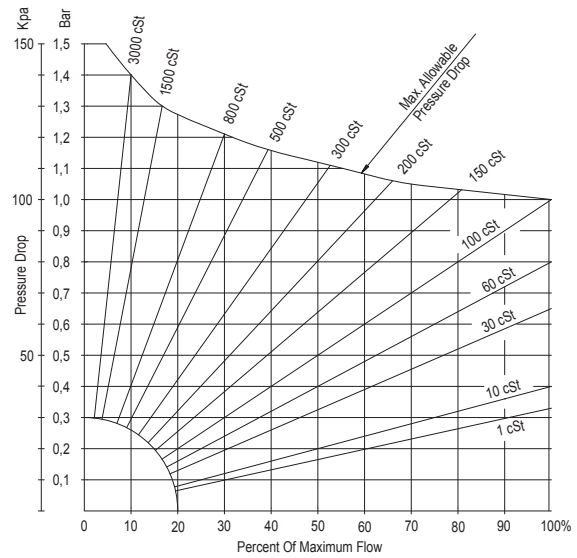

Meter size DN 50 mm: 100% = 500 l/min

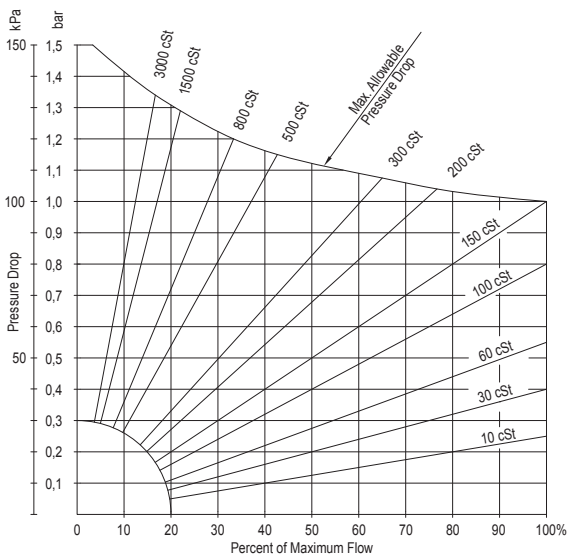

Meter size DN 80 mm: 100% = 1900 l/min

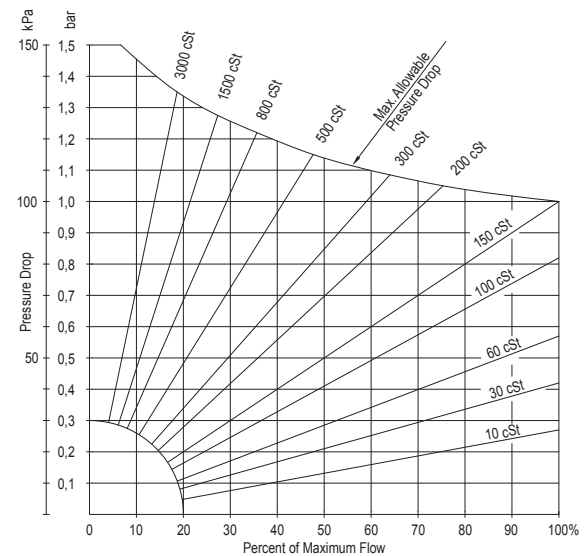

Meter size DN 100 mm: 100% = 2750 l/min

HiFlow®

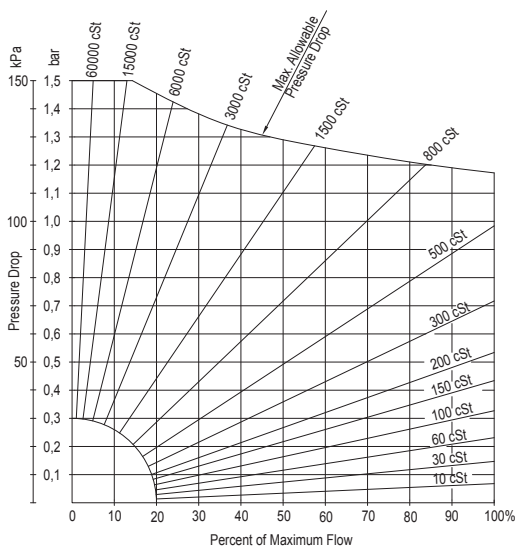

Meter size DN 150 mm: 100% = 4600 l/min

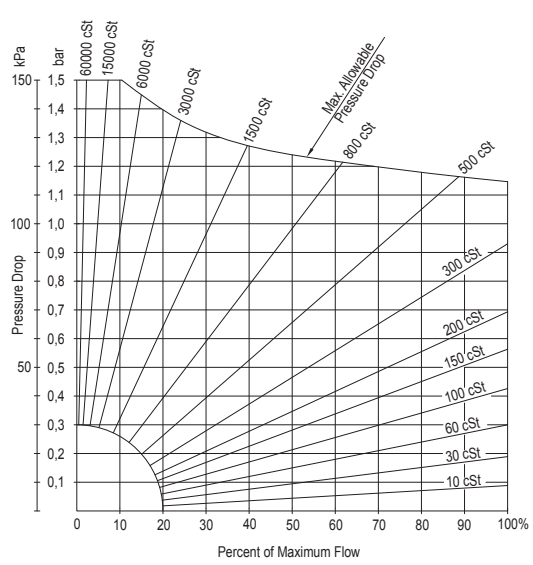

Meter size DN 200 mm: 100% = 8000 l/min

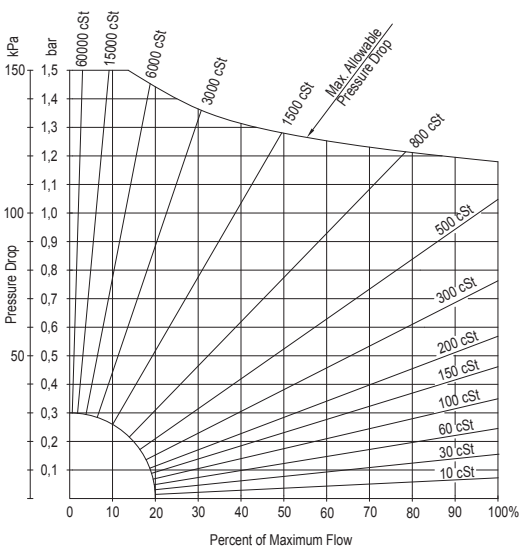

Meter size DN 250 mm: 100% = 12500 l/min

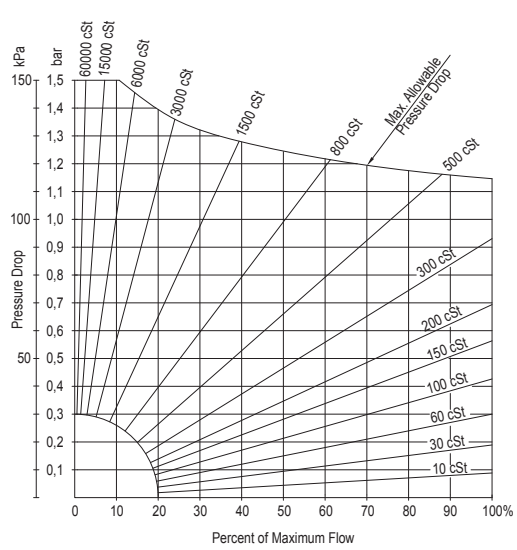

Meter size DN 300 mm: 100% = 16000 l/min

Options & accessories

Counters, pulse transmitters and accessories

VAF MidFlow®/HiFlow® meters can be fitted with various combinations of counters and pulse transmitters. All can be calibrated to read in litres, cubic meters or gallons. The following meter mounted counters and pulse transmitters are available:



Key resettable totaliser

For simple totalising jobs. Direction of reading from the top of the flowmeter. An inductive pulse transmitter can be installed in the counter adapter as optional extra.



Resettable flowmeter register

For registering delivered or transferred quantities per job and in total. Optionally available with extension between meter body and counter. Combinations with pulse transmitters are possible.



Batch counter

Electrical or pneumatic 2-stage knockoff. Optionally available with extension between meter body and counter. Combinations with pulse transmitters are possible.



Incremental pulse encoder

Dual channel optical pulse transmitter (EEX d IIB T6). Directly connected to flowmetershaft.



Ticket printer

Records and prints liquid deliveries and transactions. For use with reset and preset counters. Accumulative or zero start models available.



Calibration adapter

With pulse transmitters for remote flow monitoring and control. Pulse generators used are inductive proximity switches acc. NAMUR DIN 19234.

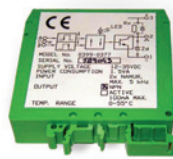

Pulse discriminator

(DIN rail mounting) to prevent pulse signal errors caused by pipeline vibrations and flow pulsations, or where other unsteady flow conditions would prevent smooth rotation of the meter. For use with 2 inductive pulse transmitters.

General

- Liquid filter/air vent;
- Appropriate liquid filtering is essential for protection of the flowmeter;
- Cooling rings for protection of the counting mechanism against operating temperatures above 120°C;
- Material certificate acc. EN 10204 3.1;
- Custody transfer accuracy certification;
- Special adaptations for accurate measurement of liquids with very high or very low viscosities, e.g. molasses or LPG;
- Helium leak-test when volatile liquids must be measured;
- Heating covers;
- Counter extension between counter and meter body for easier reading on loading platforms etc. Extension length up to 3 metres;
- Automatic temperature compensation;
- Internal flushing bores. Prevent deposits when crystallising liquids must be measured;
- Stainless steel encapsuled magnet coupling between meter body and counter adapter. Prevents corrosion by aggressive process liquids.

Electronic signal processing instrumentation

VAF Instruments offers a complete range of microprocessor controlled, analogue and digital instruments for indicating, totalising, registering and controlling liquid flows. Electronic instruments are available as modular plug-in units or in housings for wall or flush panel mounting. Output options for a number of instruments provide interfaces to chart recorders, printers, alarms and distributed control networks. VAF's engineers will be pleased to assist you in working out customized flow control systems in accordance with your requirements. At the present time our basic series of electronic flow signal processing instrumentation comprises:

- Flow computers;
- Multifunction flow controllers;
- Flow totalisers with optional temperature compensation;
- Batch controllers;
- Ratio controllers;
- Pulse amplifiers/pulse discriminators;
- Power supplies;
- Scalers;
- Frequency-to-current converters.



Applications

Some of the many applications are:

- Fuel consumption measurement of combustion engines and oil burners;
- Blending of additives in the process industry;
- Fuel oil bunkering and blending;
- Addition of catalysts to chemical reactors;
- Dyeing yarn, leather, plastics, etc.;
- Coating of sheet materials;
- Injection of oils and fats in the foodstuffs and animal feed industries;
- Flow control of dosing pumps;
- Dosing of additives in cement concrete preparation;
- Measurement of liquid movement in hydraulic systems;
- Accurate measurement of viscous liquids at low flowrates;
- Dosing of liquids in the paint, tobacco and beverage industries.



Dimensions

All dimensions apply to flowmeters with DIN PN 10/16/25 flanges.

Dimensions of flowmeters with other pressure rating are available on application.

All dimensions are in millimetres.

MidFlow®

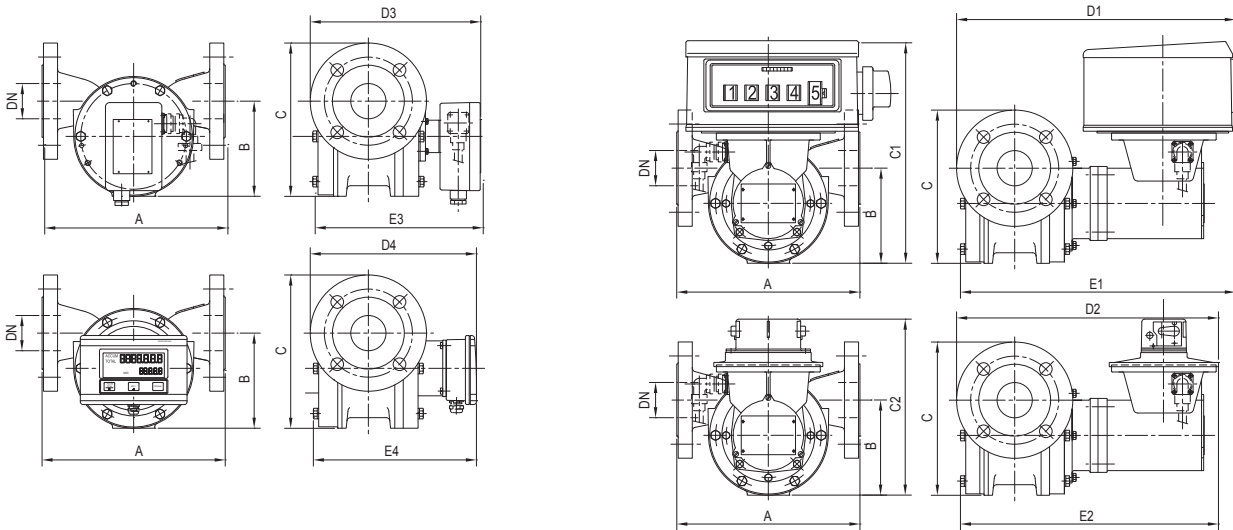

Models JZ025 to JZ100

Basic model number	J1025	J5025	J3025	J1040	J5040	J3040	J1050	J5050	J3050	J1080	J5080	J3080	J1100	J5100	J3100
Connection size	DN 25			DN 40			DN 50			DN 80			DN 100		
A	240			240			260			400			450		
B	110			110			135			243			285		
C	168			185			218			343	345	343	395	397	395
C1	300			300			315			373			400		
D1	350	354	368	372	397	395	403	477	470	494	511	504	550		
E1	348	365	348	365	393	389	413	520	502	563	570	552	638		
C2	235			235			250			308			335		
D2	326	330	343	347	372	370	378	452	445	469	487	480	526		
E2	324	340	324	340	369	365	389	496	478	538	546	528	613		
D3	240	244	258	262	287	285	293	367	360	384	401	394	440		
E3	238	255	238	255	283	279	303	410	392	453	460	442	528		
D4	217	221	235	239	264	262	270	344	337	361	378	371	417		
E4	215	232	215	232	260	256	280	387	369	430	437	419	505		

Dimensions

Flange dimensions apply to flowmeters with DIN PN 10 flanges.

Dimensions of flowmeters with other pressure ratings are available on application.

All dimensions are in millimeters.

HiFlow®

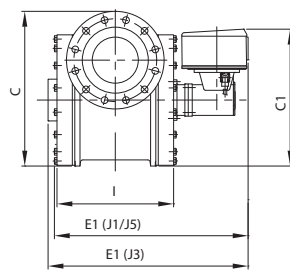
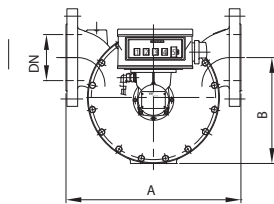

Model no. JZ150 and JZ200

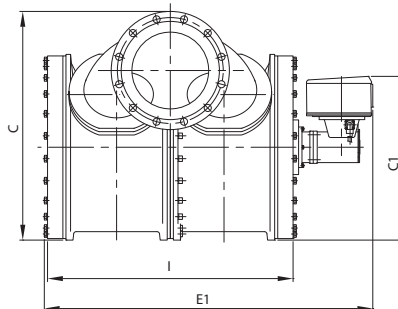
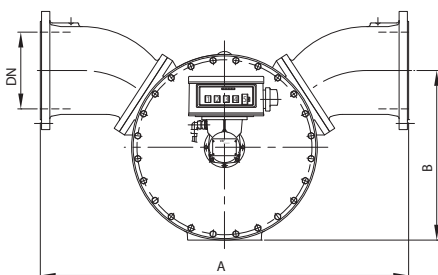

Model no. J5250 and J5300

Basic model number	J5150	J5200	J5250	J5300
Connection size	DN 150	DN 200	DN 250	DN 300
A	550	900	1200	1200
B	345	528	553	578
C	487	708	751	801
E	599	689	1057	1057
I	360	450	800	800

Quotation & ordering information

For proper selection of the suitable MidFlow®/HiFlow® meter the following data should be determined:

Liquid data:

1. **Process liquid** (trade name or chemical composition):
2. **Flowrate** [l/min] minimum: _____ continuous: _____ maximum: _____
3. **Operating pressure range** [bar]: _____ allowable pressure drop [bar]: _____
4. **Operating temperature range** [°C] process liquid: _____ ambient: _____
5. **Viscosity at operating conditions:** [cSt]

Flowmeter data:

6. **Basic model number:** _____
7. **Diameter liquid piping:** _____
8. **Wetted parts material:** ductile iron carbon steel AISI 316
9. **Connection flanges:** DIN PN [bar]: _____ ANSI RF [lbs]: _____ JIS [K]: _____
10. **Direction to flow:** left to right right to left top to bottom bottom to top
11. **Local counter:** no built-on counter (continue with step 12)
 key-resettable totaliser
 resettable flowmeter register
 batch counter: electrical pneumatic
 knock-off: 1 stage knock-off 2 stage knock-off
 ticket printer (on resettable flowmeter register or batch counter)
12. **Pulse transmitter:** number of low speed inductive pulse transmitter(s): _____ ; preferred pulses/litre:
 number of high speed inductive pulse transmitter(s): _____ ; preferred pulses/litre:
 pulse discriminator, (DIN rail mounting) using 2 inductive pulse transmitters
 incremental pulse encoder
13. **Liquid filter:** required not required
14. **Special certification:** inspection by customer standard factory calibration
 inspection by classification authority:
 factory test and material certificate acc. EN 10204 3.1
 MID other: _____
15. **Tagging:** paper tag stn. stl. tag fixed to flowmeter
16. **Other options & accessories:** _____

Name: _____

Place and date: _____

For further information see relevant Product Bulletins or www.vaf.nl

Represented by