

*power & dynamic: our low-backlash,  
low-noise, highly-dynamic geared  
motors in connection with our  
modular frequency inverters - the  
individual system solution for all  
your applications.*

**watt  
drive** 



the *system* drive.

the power of motion.

**: The Drivers.**



**A suitable drive solution for each application.**



**← translatory movement**



**Challenging requirements. Optimum solutions.**

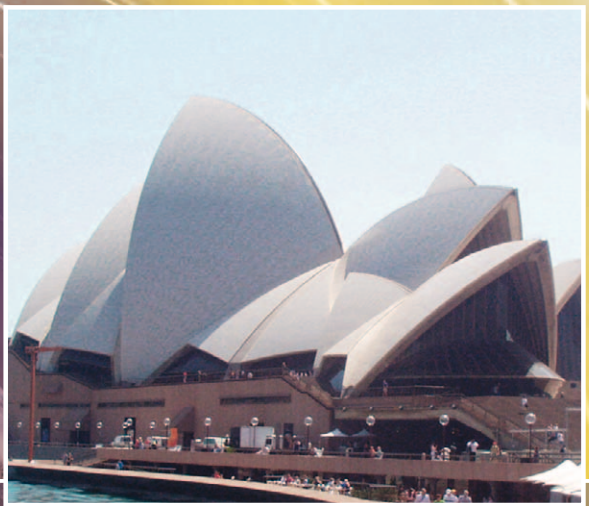

rotatory movement 



**Modular Drive System WATT MAS:**

**Drive Systems**

Watt Brain Power, gear units, motors and electronic drives.

**Drive Electronics**

Frequency inverters, soft starters, control and display devices.

**Motor System**

Integral motors, motor modules, induction servo motors, IEC standard motors

**Gear System**

Helical, parallel shaft, shaft mounted, helical worm, helical bevel and angle parallel shaft gear units.

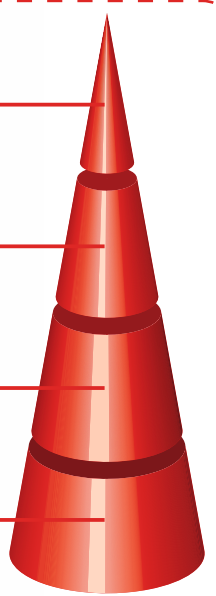

# : Watt Drive Systems.



**Cyclical system**

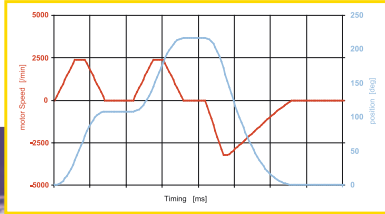

**Torque follower**

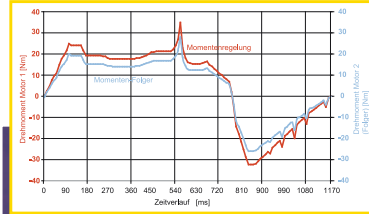

**High starting torque**

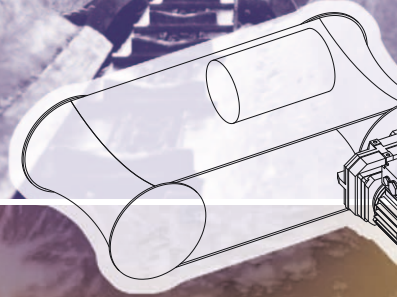
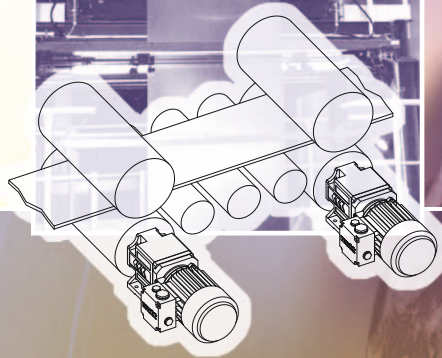
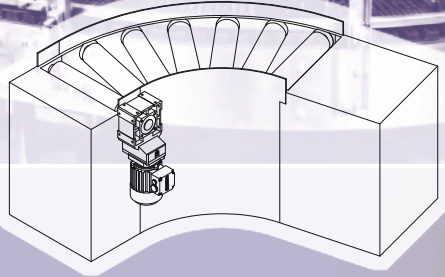
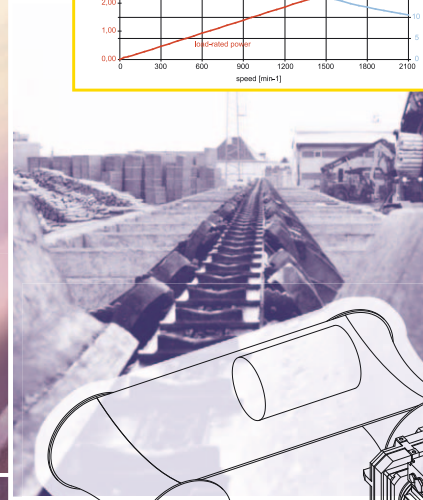
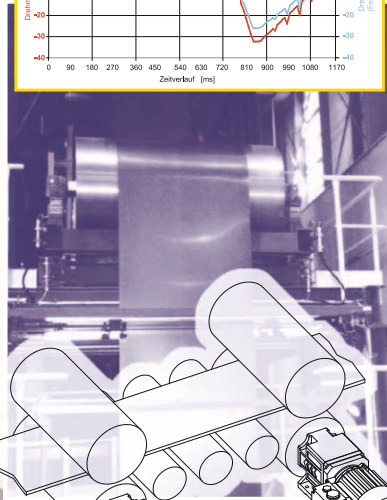
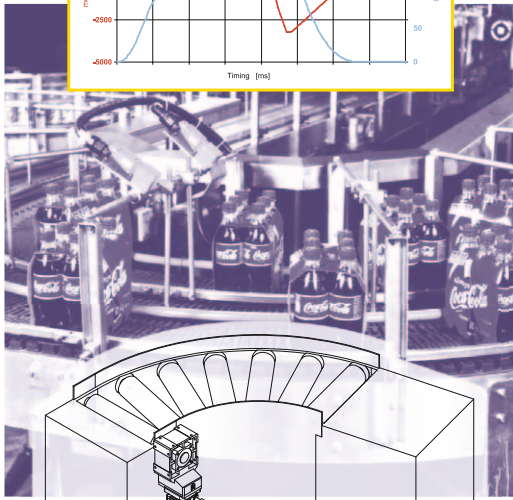
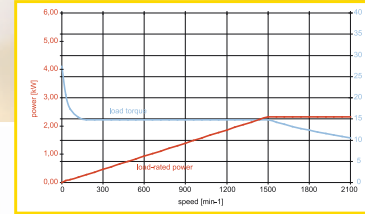

← **translatory movement**



**Challenging requirements. Optimum solutions.**

**Mechanical brake control**

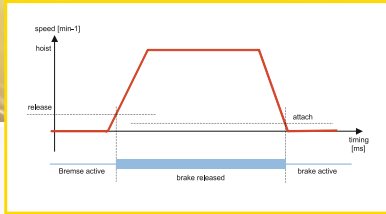

**Squared torque characteristics**

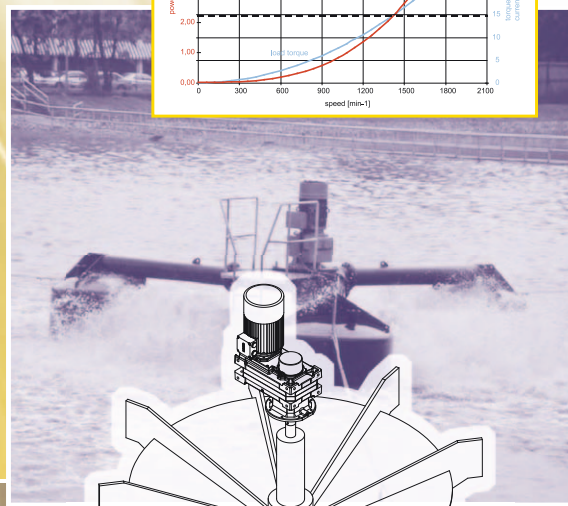
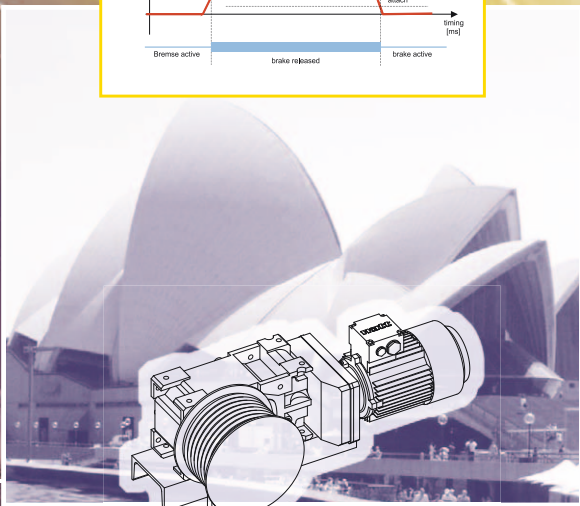
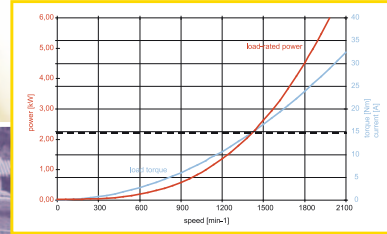

rotatory movement 

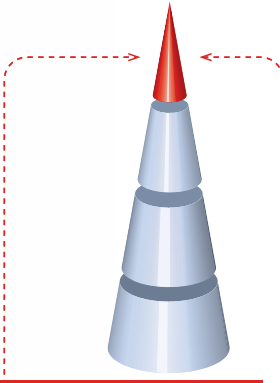
**Drive Systems**  
Watt Brain Power, gear units, motors and electronic drives.

# : The Torque Generators.



• S-line



## Challenge

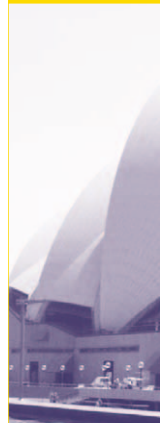

### Innovative technology for increasing performance

With its S-line, B-line, E-line and P-line frequency inverter program in the 0.2 to 90 kW range, Watt Drive takes the concept of the modular drive system to its logical conclusion. These frequency inverters stand out due to their excellent control features, construction volume, great operating convenience and open communication.

The differences between the four programs lie primarily in the control features and thus the starting torque and dynamic performance achieved: The S models are V/F controlled, while the B, E and P range consists of vector-controlled frequency inverters. The E-line

offers implemented EMC filters and brake choppers in series, as well as many possible extensions for the digital and analog in- and outputs. Moreover an integrated SPS control is available. The P range features distributed intelligence e.g. for positioning tasks. This complete range of modular drive control units offers the technically best and most cost-effective drive solution for any requirement, from simple open loop control to top dynamic closed loop process control and positioning applications.

• B-line • E-line • P-line



ing requirements.

Optimum solutions.



**S-line  
VFD-S**  
(ECO-line)



**B-line  
VFD-B**  
(OPTI-line)



**E-line  
VFD-E**



**P-line  
P6000**  
(PROFI-line)

Frequency inverters.

**Communication.**

All devices have serial RS 232 or RS 485 interfaces as standard equipment. ModBus-protocol (S-line, B-line und E-line) or CANopen (P-line) are always on board.

Several bus interfaces allow integration of the frequency inverters into complex automation solutions. Connections to the following standard industrial bus systems can be easily and cost-effectively implemented using optional cards:

- S-, B- and E-line:
  - ProfiBus DP, - DeviceNet,
  - CANopen, - LonWorks

- P-line:
  - ProfiBus DP

**Ultracompact Design.**

Thanks to the use of highly integrated power modules, the design of all three families is extremely compact. The P-line frequency inverters are suitable for mounting straight onto the next device without any space in between thanks to their special "book-type" design. Reducing space requirements in the control cabinet means saving costs.

**Plug and Drive.**

Simply connect and start the application. Preset, practical parameters guarantee speedy operation.

Do not waste time – save costs.

**User-friendly.**

Large displays and clear arrangement of the control displays make the parameterization and control easy. All functions can be conveniently selected using simple operator prompts. The potentiometer, which is standard equipment of the S-line allows a quick and continuous speed control. The motor is brought up to the speed with just two buttons and a turn at the potentiometer.

The straightforward programming tools were developed with "parameterizing instead of programming" in mind.

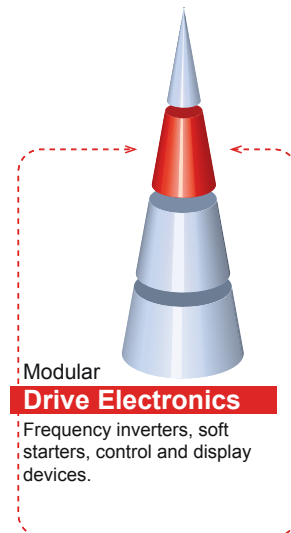

Modular  
**Drive Electronics**  
Frequency inverters, soft starters, control and display devices.

# : Modular Frequency Inverter Program. Your Individual System Solution.



Series	Voltage Control t.	Power range [kW]																				
		0.25	0.37	0.75	1.5	2.2	3.0	3.7	4.0	5.5	7.5	11	15	18.5	22	30	37	45	55	75	90	
 <b>S - line</b> VFD-S	1~230V V/F	●	●	●	●	●																
	3~400V/460V V/F		●	●	●	●																
 <b>B - line</b> VFD-B	1~230V V/F, SVC, VC			●	●	●																
	3~400V/460V V/F, SVC, VC			●	●	●		●		●	●	●	●	●	●	●	●	●	●	●	●	●
 <b>E - line</b> VFD-E	1~230V V/F, SVC, VC	●	●	●	●	●																
	3~400V/460V V/F, SVC, VC		●	●	●	●		●		●	●	●	●	●	●							
 <b>P - line</b> P6000	1~230V V/F, VC, Torque- and Position control			●	●																	
	3~400V/460V V/F, VC, Torque- and Position control			●	●	●	●		●	●	●	●	●	●	●	●	●	●	●	●	●	●



## Characteristics

- Control strategy: V/F control
- Slim and compact
- Commissioning and maintenance particularly easy
- Built-in EMC filter for first and second environment (single phase devices) [EU]
- Adjustable V/F characteristic and slip compensation for greater speed accuracy and higher torque at all speeds
- Integrated brake chopper
- RS 485 interface with integrated Modbus RTU protocol
- Optional communication module for ProfiBus DP, DeviceNet, CANopen and LonWorks
- PTC-connection possible
- Programmable multi-step speed (also with stop and reverse travel)
- Rugged and reliable
- Up to 480 Vac supply voltage - for unlimited operation in the United States
- Obtainable accessory: manual operation unit for the saving of up to 3 parameter records

- Control strategy: V/F control, sensorless vector control (SVC) and vector control with encoder (VC)
- Commissioning and maintenance particularly easy – concept identical to S-line
- Clear, seven-segment display also for mounting on control cabinet door
- Adjustable V/F characteristic and slip compensation plus sensorless vector control algorithm (SVC) especially for high motor torque at lower speeds (from 0.1 Hz)
- Optional pulse encoder board for real closed-loop speed control (can be switched over to TTL or HTL encoder in any circuit logic)
- Integrated brake chopper (up to 11 kW device)
- Three-loop PID controller
- RS 485 interface with integrated Modbus RTU protocol
- Optional communication module for ProfiBus DP, DeviceNet, CANopen and LonWorks
- PTC-connection possible
- Programmable multi-step speed (also with stop and reverse travel)
- Up to 480 Vac supply voltage - for unlimited operation in the United States
- Control function for auxiliary drives and many other special features
- Rugged and reliable
- Quick-acting output fuses for additional protection of the output stage
- Obtainable accessory: manual operation unit for the saving of up to 3 parameter records

- Control strategy: V/F control, sensorless vector control (SVC) and vector control with encoder (VC)
- Easy start-up, same handling structure as S- and B-line
- Clear, seven-segment display also for mounting on control cabinet door
- Integrated brake choppers in all performance categories
- Integrated EMC filter in all performance categories
- Adjustable V/f-characteristic with slip compensation, very good vector-regulation-algorithm (SVC) specialised on high motor torque already at low speed (from 0.1Hz)
- Expansion cards with the following functions: -Keypad with torque potentiometer, - Additional digital and analog in- and outputs (also relays)
- Three-loop PID controller
- RS 485 interface with integrated Modbus RTU protocol
- Optional communication module for ProfiBus DP, DeviceNet, CANopen and LonWorks
- PTC-connection possible
- Up to 480 Vac supply voltage - for unlimited operation in the United States
- Substantial protectional functions concerning inverter and motor
- Up to 1.5kW also available as cold-plate-variant
- Integrated SPS-control, programmable in the ladder diagram view or after an instruction set
- Obtainable accessory: manual operation unit for the saving of up to 3 parameter records, adapter plate for rail mounting, connection plate for motor cable-shield

- Control strategy: V/F control and vector control with encoder (VC)
- Slim for building on at the side (book type)
- Programmable like a PLC
- Position control with 16 complete sets of motions from a table or using freely programmable commands
- Clear parameterization and programming using the PROFI-Tool programming software for PCs
- Integrated brake chopper (over the entire power range up to 90 kW)
- CANopen on board
- Speed evaluation for HTL and TTL encoder and absolute position evaluation for SSI absolute encoder on board
- Master-slave control and control/speed encoder evaluation in the standard
- Sensorless vector control, closed-loop speed control, real torque control with speed monitoring and position control with path planning (on VC-regulation with encoder feedback)
- Plug-in terminals for control and power (up to 7.5 kW for power terminals)
- Separate input for motor temperature monitoring using contact, PTC or KTY
- Optional operating unit with parameter and PLC program copying function
- Optional I/O expansion module and ProfiBus module

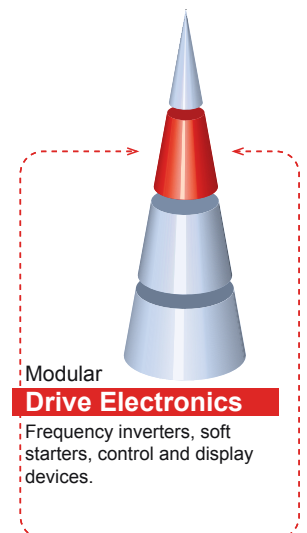

**: The runners ...**



**EUSAS**



**A Motor for 100Hz  
Characteristics and any  
Voltage Worldwide.**

WATT EUSAS motors are top quality, three-phase AC industrial models from Watt Drive's customer-oriented motor system. EUSAS stands for Europe - US - ASia and means that the wide voltage range and simple voltage selector in the terminal box enable the motor to be operated with virtually any supply voltage and frequency worldwide.

**100Hz Characteristic -  
Double Power.**

In frequency inverter operation WATT EUSAS motors can be controlled using the 87/100Hz voltage/frequency characteristic without special windings. As a result, the same motor size can output up to double the power without being overloaded.

**Connection Modes.**

The Watt Drive quality motor uses a 9-pin terminal block and therefore can be switched in star, delta, double star and double delta with its wide-range winding.

This way, the motor can cover all worldwide supply voltages.

In the range of performance 0.12 to incl. 2.2kW the motors can be operated in the following voltage range - 220-240V (D), 110-120V (DD), 380-420V (Y) and 190-210V (YY).

From 3.0kW on the following voltage ranges are possible - 380-420V (D), 190-210V (DD), 660-690V (Y) and 330-365V (YY) each for 50 and 60Hz.



**WATT-SERVO-MOTOR  
(asynchronous)**

The Watt induction servo motor is an evolutionary development based on the proven Watt-EU-SAS-Motor. The new motor is now optimized for industrial drive tasks, requiring dynamic closedloop speed control in frequency inverters and having additional special demands:

- High dynamic during acceleration and deceleration as well on the compensation of speed deviations
- High speed accuracy
- High mechanical and electrical robustness of the whole drive system
- Large speed range
- High accuracy of running (also at low speed)



**Challenging requirements.**

**Optimum solutions.**

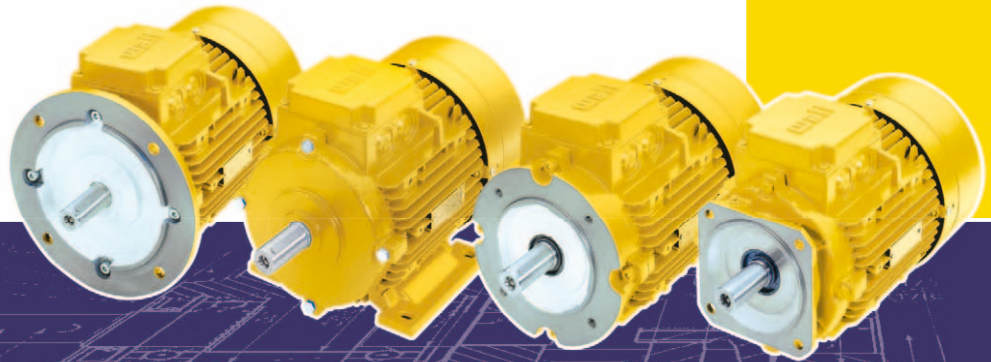

**EUSAS Benefits at a Glance:**

- Wide-range winding from 3x190 up to 3x690V at 50/60Hz with 9 terminals
- 100 or 87 Hz characteristic in frequency inverter operation
- Switchable voltage
- High efficiency to eff2
- Low weight
- Tropic-proof insulation system
- Operating temperature -30°C to +60°C
- Nameplate with 50/60Hz data
- Reinforced bearings
- High strength rotor shaft
- Rotor shaft prepared for mounting encoders, tachometers, backstops etc.
- Protection Class IP55

- Insulation Class (temperature rise Class B)

**Modular Motor System.**

The WATT Drive system motor guarantees quick and economic availability in all possible units due to its sophisticated components:

- Motors for special voltages, power and frequencies
- Brake motors
- Motors with tacho generators, encoders, backstops, forced cooling or without fans and explosion proof versions.
- Modular terminal boxes and connect concept

Together with Watt Drive frequency inverters, the motors constitute a perfectly balanced drive system.

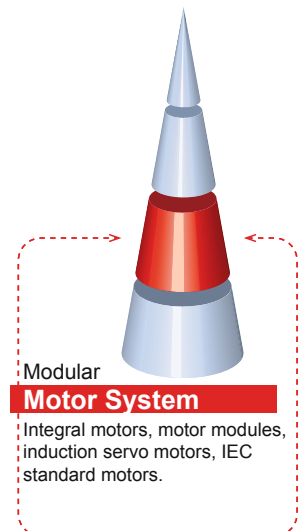

# : WATT-System motors.



## The Three-Phase Motors for any Voltage Worldwide

### WATT-EUSAS-Motors

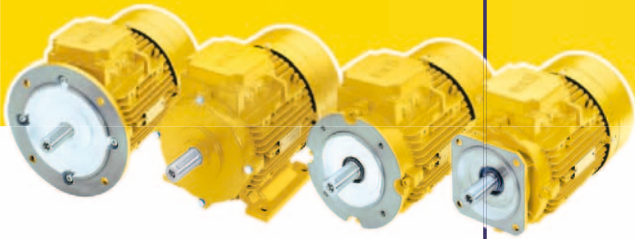

Design: WAG (B3), WAF (B5),  
WAC (B14),  
WAR (B5-special)

IEC size: 63 - 315

Possible number of poles: 2-, 4-, 6-, 8-pole

Performance area: 0.04 - 200 kW

### Characteristics curve

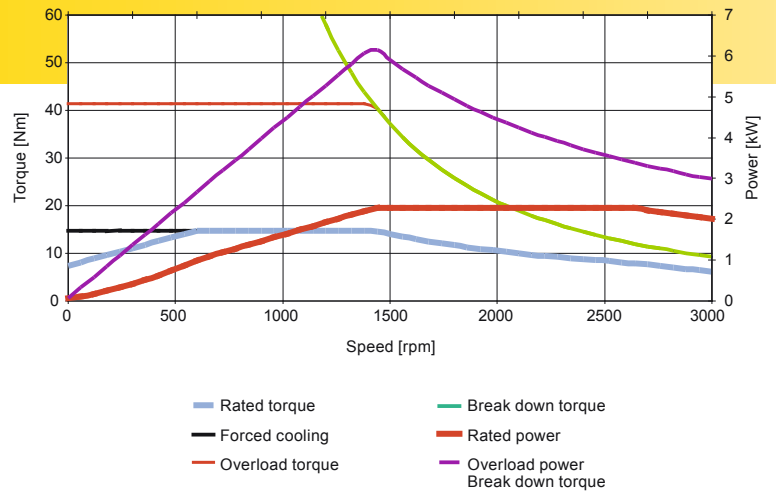

### WATT-SERVO-Motors (asynchronous)

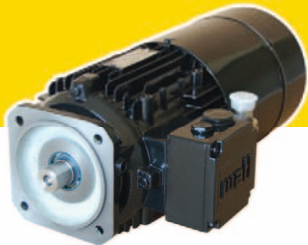

Design: WSR

IEC size: 71 - 160

Possible number of poles: 4-pole

Rated torque: 1.8 - 100 Nm

### Characteristics curve

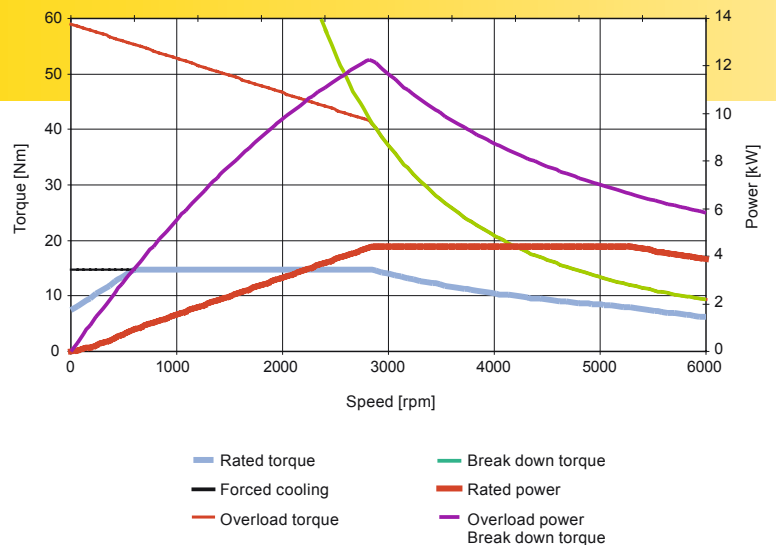

Technical data is subject to change without prior notice.

### Modular Motor System

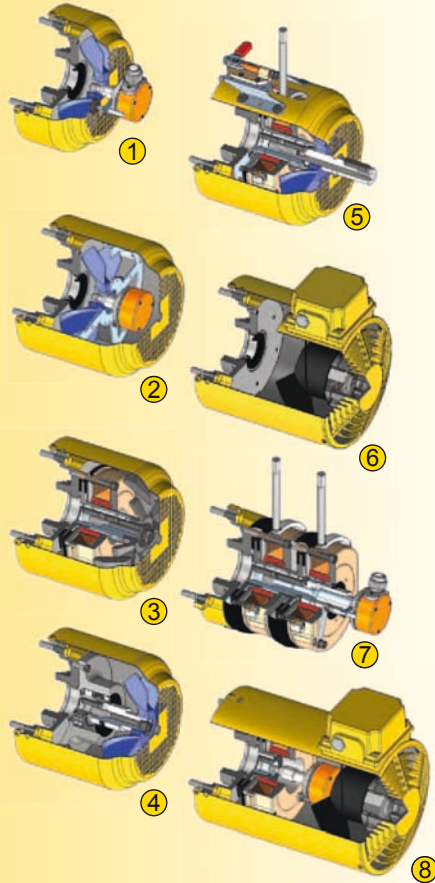

- ① Motor with encoder (outside the fan cover)
- ② Motor with encoder (inside the fan cover)
- ③ Brake motor with fly wheel fan
- ④ Motor with back stop
- ⑤ Brake motor with manual release, locking device and second shaft end
- ⑥ Motor with forced cooling
- ⑦ Brake motor unventilated with double brake, manual release and encoder
- ⑧ Brake motor with encoder and forced cooling

### Characteristics

- Wide-range-voltage winding from 3x190 up to 3x690V at 50/60Hz with 9 terminals
- 100 / 87 Hz characteristic in frequency inverter operation
- Voltage selection
- High efficiency to eff2
- Low weight
- Tropic-proof insulation system
- Operating temperature -30°C to +60°C
- Rating plate with 50/60Hz data
- Reinforced bearings
- High strength rotor shaft
- Rotor shaft prepared for mounting encoders, tachometers, backstops etc.
- Protection Class IP55
- Insulation Class F (Class B capability)
- System motor, prepared for flexible mounting and resetting of special options

### Modular Motor System

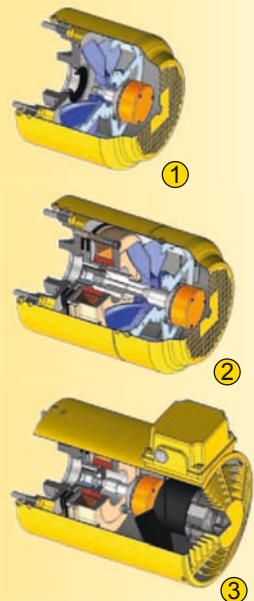

- ① Standard WATT-SERVO-Motor with built-in encoder
- ② with encoder and brake
- ③ with encoder, brake and forced cooling

### Characteristics

- Mounting position IM B5 - gear-box motor with square flange
- Designed for both 50/60 or 100/120Hz base frequency in the proven EUSAS wiring
- Built in encoder as standard - protected by the fan cover
- Temperature switch (n.c.c.) for supervision of the motor temperature
- All-over protection IP55
- Ball bearing with lubrication for 40.000 hour operation under normal operation conditions
- Additional options from the EUSAS-program

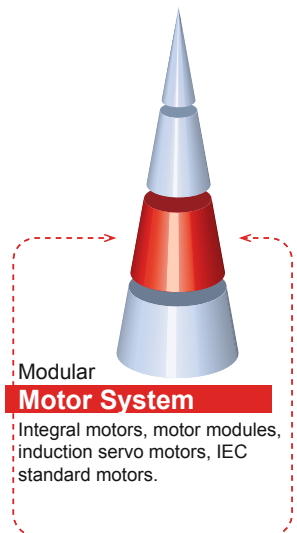

**: The Power Makers.**



### **Top Quality Geared Motors.**

Watt Drive geared motors are the electro-mechanical key elements for extremely low-backlash, fast but smoothly running and highly dynamic drive systems. Our heavy-duty gear units are built to withstand the toughest industrial applications.

The gear cases are machined on all sides and permit diverse mounting positions and applications, making them much sought after in the industry. As a result our geared motors are often to be found as part of

our customer's own machines.

The extreme running smoothness of Watt Drive gear units and the outstanding load capacity of WATT teeth are achieved with 3D design supported by FEM (Finite Element Method). This tooth geometry guarantees optimum rolling contact under load.

The special tooth root design in combination with tooth angle, depth, the materials used and surface finish maximizes load capacity. This high gearing capacity enables smaller wheels to be used for the same torque, and smaller gears with excep-

tional power density also increase reliability. Watt Drive geared motors are consequently incredible space savers.

Gearing manufactured with such micro-geometric precision allows the tooth space required for troublefree rolling contact to be substantially reduced and therefore the gear backlash to be minimized.

Double chamber shaft seals developed by Watt Drive, made of special HNBR and completely leak tight, are used as standard in parallel-shaft, shaft-mounted and helical worm gears.

Challenging requirements.



Optimum solutions.

### We Meet Individual Customer Specifications.

The innovative Watt Drive modular gear system consists of a minimum number of different parts. Intelligent part design enables them to be used in various types of gear units. Individual customer specifications can therefore be met efficiently in a short space of time.

Watt Drive's modular gear technology meets and indeed exceeds the requirements of advanced drive systems:

- Excellent power density
- Minimum backlash
- Extreme running smoothness
- Diverse mounting options
- Maximum reliability
- High variability

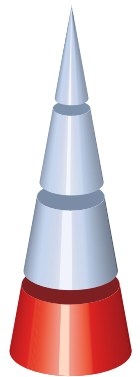

Modular  
**Gear System**

Helical, parallel shaft, shaft mounted, helical worm, helical bevel and angle parallel shaft gear units.

# : The Architects of Reliable Geared Motors.



**WATT MAS Helical Geared Motor**

**Power:** 0.12-55 kW  
**Torque:** 27-14,000 Nm  
**Ratio:** 1-8,600

Uniblock design for foot and flange mounting. Gear case machined on all sides for universal application. Revolutionary new gearing geometry here and in all the other models results in exceptional running smoothness. For special environmental conditions the gear unit can be fitted with two shaft seals.



**WATT MAS Parallel-Shaft Geared Motor**

**Power:** 0.12-55 kW  
**Torque:** 2,800-14,000 Nm  
**Ratio:** 6-18,000

The uniblock gear case machined on all sides, the particularly stable case and minimum outside dimensions enable diverse mounting options and applications. As a result, these motors often form an integral part of our customers' machine designs. High precision manufacturing and top gearing quality guarantee minimum backlash in Watt Drive gear units.



**WATT MAS Shaft-Mounted Geared Motor**

**Power:** 0.12-22 kW  
**Torque:** 27-2,800 Nm  
**Ratio:** 1-4,000

In addition to the benefits of the parallel-mounted geared motor, this is an extremely economical model, especially for shaft and flange mounting. Special double-chamber shaft seals developed by Watt Drive that guarantee complete leak tightness are used as standard, as in the parallel-shaft geared motor.

## Quality Assurance - Products All Manufactured In-house.

The production of the components for our geared motors is 100 per cent vertically integrated. The latest plant and machinery and a quality management system certified to ISO 9001 maximize customer benefit by delivering high flexibility, extreme precision and outstanding reliability.

Watt Drive has thus earned itself a reputation for building rugged, virtually indestructible geared motors.

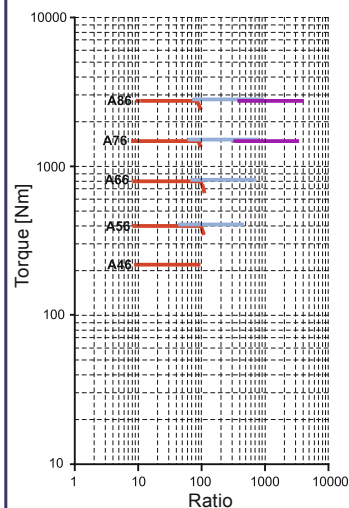
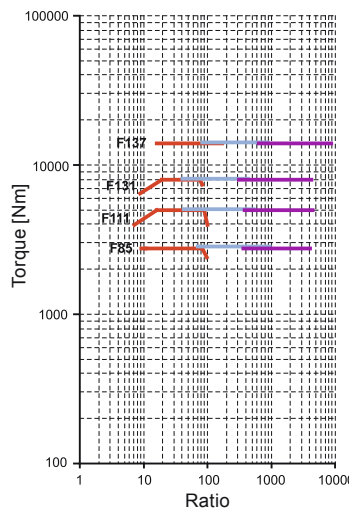
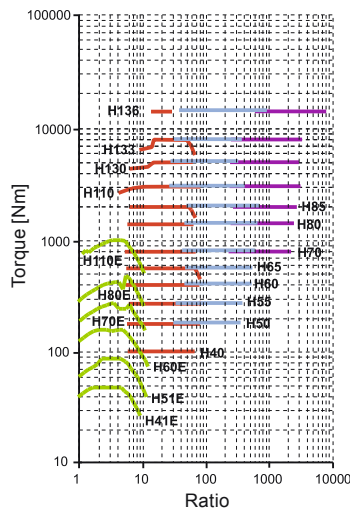

- Key:**
- Single reduction
  - Double reduction
  - Triple reduction
  - Fourstage reduction
  - Fivestage reduction





**WATT MAS Helical Worm Geared Motor**

**Power:** 0.12-7.5 kW  
**Torque:** 30-1,400 Nm  
**Ratio:** 3-3,400

Due to the unique combination of newly developed worm wheel material with special lubricants, extreme precision and optimized shapes, this powerful motor achieves comparatively high levels of efficiency and torque. The case machined on all sides enables diverse mounting options. Double-chamber shaft seals made of HNBR are used as standard, guaranteeing complete leak tightness.

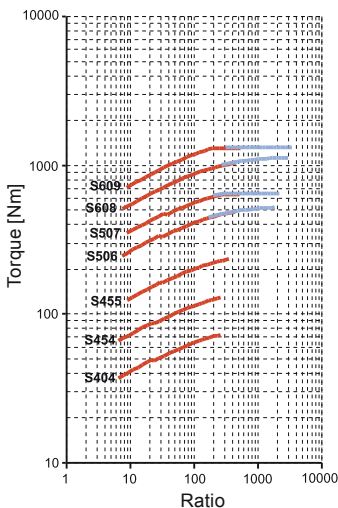

**WATT MAS Helical Bevel Geared Motor**

**Power:** 0.12-55 kW  
**Torque:** 100-14,000 Nm  
**Ratio:** 6-8,600

The compact and structure-optimized gear case of the helical bevel gears distinguish themselves by being machined on all sides and are therefore, ready for a variety of mounting options and applications. The unique motor position provides an almost flat and easy to mount on "machine-interface". Various standard shaft executions and the double-chamber-shaft seals, developed by Watt Drive, are ready for use. Shaft and flange dimensions are equal to our helical gears.

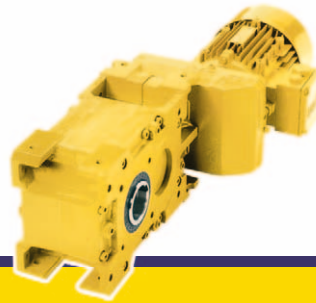
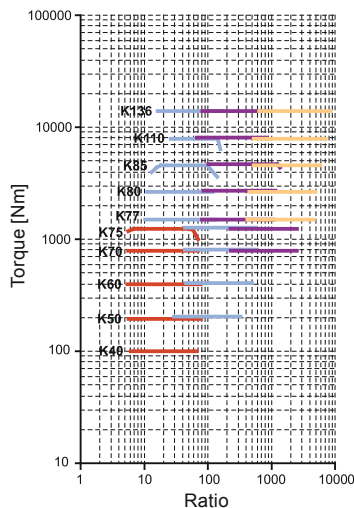

**WATT MAS Angle Parallel Shaft Geared M.**

**Power:** 0.12-45 kW  
**Torque:** 1,200-10,000 Nm  
**Ratio:** 10-7,100

These angle parallel shaft gears are machined on all sides and the primary gear unit with motor can be turned through 90°. As a result the best motor position for the application can be found. This feature also allows the housing to be ultra-flat. In addition, there are models with support noses for shaft mounted applications and output flanges for easy fixing.

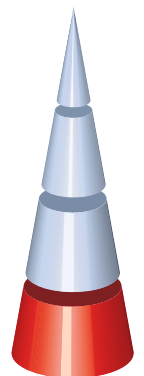
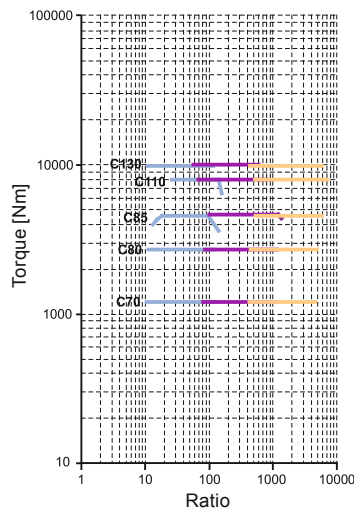

**Modular Gear System**  
Helical, parallel shaft, shaft mounted, helical worm, helical bevel and angle parallel shaft gear units.

# : Modular Drive System.



A modular system that satisfies every requirement.

Watt Drive's remarkable geared motor program offers manifold possible variations and motor options that can fulfil all customers' requirements.

### Assembly and attachment variants:

It goes without saying that the Watt Drive system provides for all the conventional means of attachment, such as flange-mounts, foot-mounts and torque arms. The special feature of this WATT product is its **UNI-BLOCK DESIGN**: the casing is machined on all sides, which further increases the number of possible attachment variants.

### Adapter kit:

WATT adapters provide a very simple „dry“ way of attaching standard IEC or NEMA motors, servomotors or special motors to Watt Drive's gear systems. Many special motors (servos) can be attached directly to Watt Drive gear systems without any unwieldy additional mass, a highly efficient method particularly for high-speed applications. The input shaft unit can be used to run the drive via a belt or flexible coupling.

### The modular frequency inverter program.

Watt Drive's frequency inverter program S-line, B-line, E-line and P-line - ranging from 0.2 to 90 kW - are a consistent extension of the principle of modular drive system assembly kits. These frequency inverters are remarkable for their excellent regulator properties, compact form, ease of operation and intelligent controls.

## SHAFT

## ASSEMBLY, MOUNTING

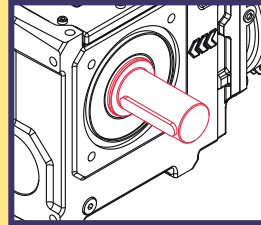

Output shaft

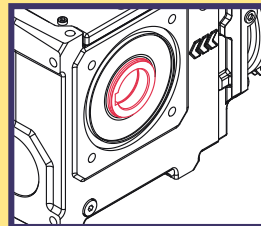

Hollow shaft

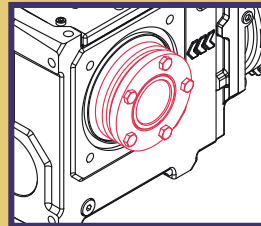

Hollow shaft + Shrink disc

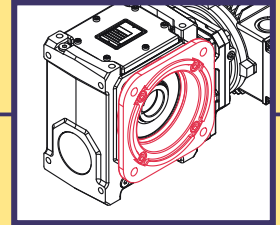

Flange

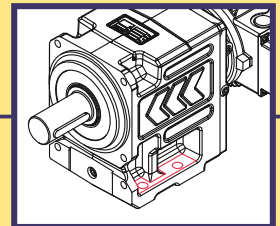

Foot

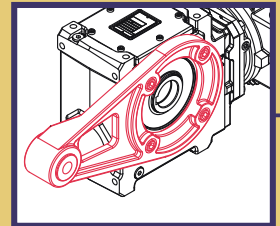

Torque arm

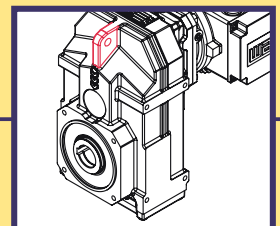

Shaft mounted type

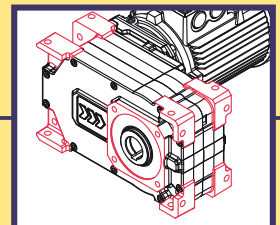

Uniblock type

**GEAR TYPE**

**INPUT TYPES**

**BUILT-ON MOTORS  
IEC MOTORS**

**MODULAR  
MOTOR SYSTEM**

**ELECTRONIC  
SYSTEM**



Helical gear unit

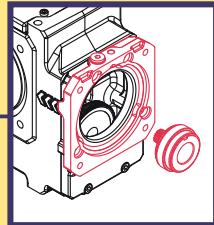

Direct mounting



EUSAS Motor WAR

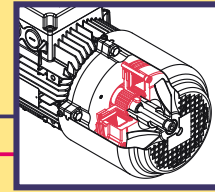

Brake



S-line



Parallel shaft gear unit

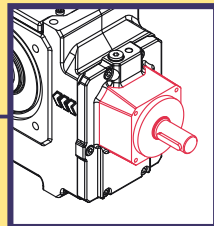

Input shaft unit



Asynchronous  
servo motor WSR

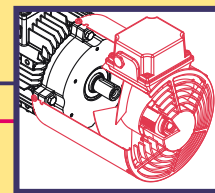

Forced cooling



B-line



Shaft mounted gear unit

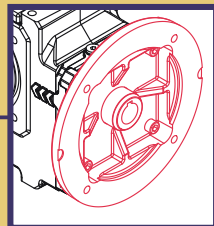

IEC, NEMA adapter



IEC-Motor WAF

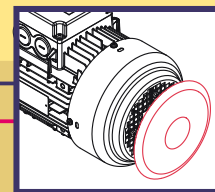

Protection cap



E-line



Helical worm gear unit

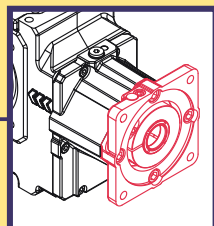

SERVO adapter



IEC-Motor WAG

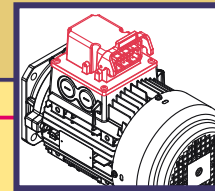

Connection / Switches



P-line

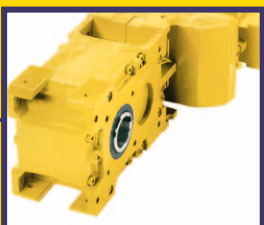

Angle parallel shaft gear u.



IEC-Motor WAC

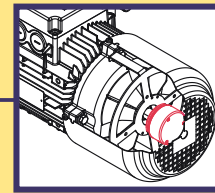

Encoder

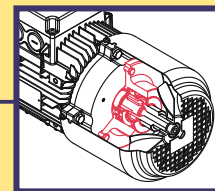

Backstop

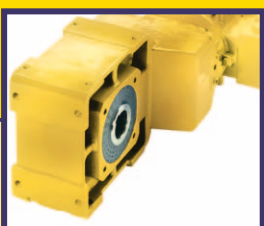

Helical bevel gear unit

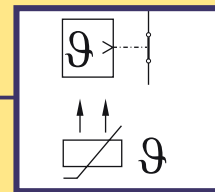

Motor protection