

# HAUG Ionization - for the elimination of electrostatic charges

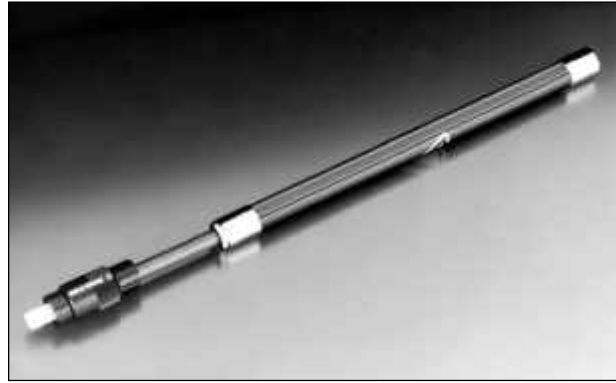

**EI RN**

## Static Line EI RN

The HAUG EI RN ionizing bar is a powerful and rugged piece of equipment. Its construction satisfies all technical requirements and it has proven its value repeatedly in the removal of electrostatic charges during roll, sheet and web (continuous product) processing. Production-interfering surface charges can be removed reliably and effectively – even at high operating speeds (ills. 1 and 2).

The coaxial high-voltage plug connector of the HAUG System X-2000 (ill. 3) offers a unique advantage in that the gastight high-voltage plug can be connected to the HAUG power pack easily and without tools. The flexible, coaxially shielded cable connects the ionizing unit with the voltage supply.

The round construction of the EI RN ionizing bar permits the exact axial adjustment in the direction of travel of the material. The ionizing bar is safe to touch. Special wear-resistant electrodes guarantee long service life.

## HAUG ionizing systems

consist of the following components:

- A power pack which supplies the ionizer by means of a high-voltage transformer with 7 – 8 kV and
- various ionizers which are connected to the power pack.

**ill. 1**

**EI RN**

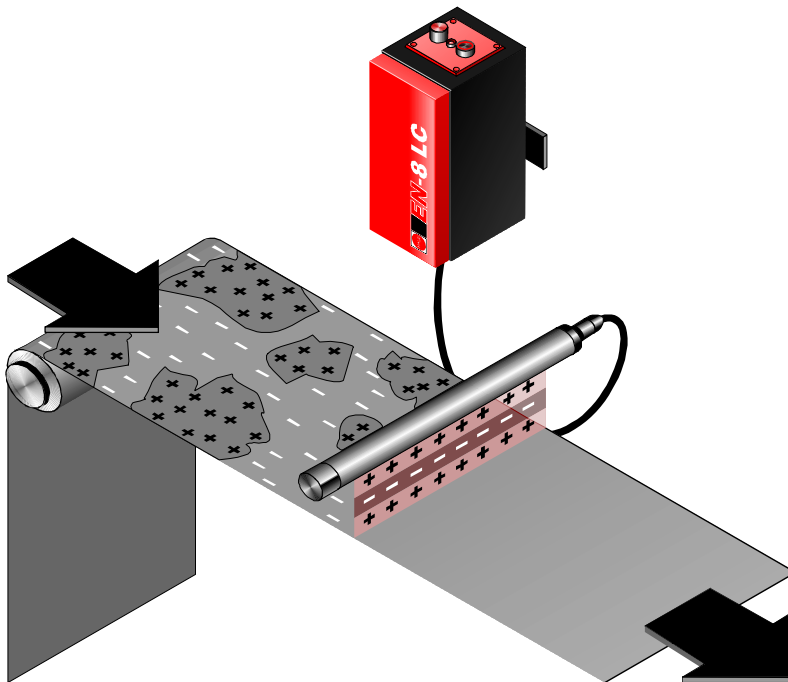

**ill. 2**

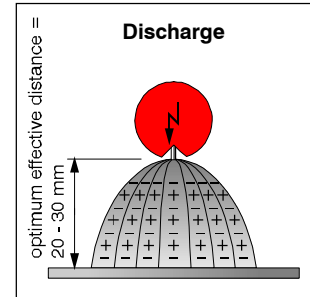

**ill. 3**

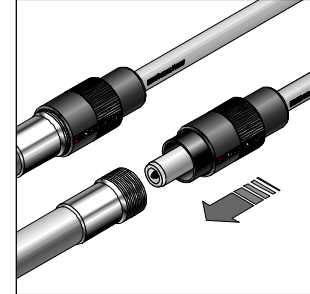

## Recommendation

HAUG ionizing bars are used with machines in the packaging, film, printing, and textile industries, as well as for many other industrial applications. It is recommended that two ionizing bars be installed above and below the material web.

The ionizing bar is suitable for feed speeds up to 100 m/min.

## Further types of bars are available

- **EI RNE:** as EI RN, but with high-voltage connection at the end of the bar for series connection of ionizing units.
- **EI RA:** without HT-cable, suitable for connection of a flexible, separate high-voltage cable (type VK-Norm, VK-ATL a.o.)
- **EI RAE:** as EI RA, but with high-voltage connection at the end of the bar for series connection of ionizing units.

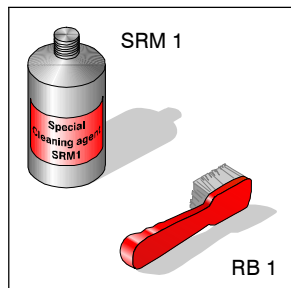
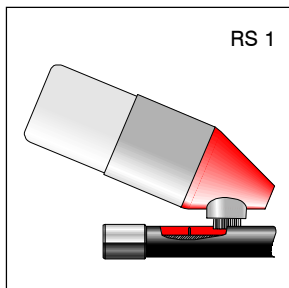

**Static Line - Ionizing bar EI RN**



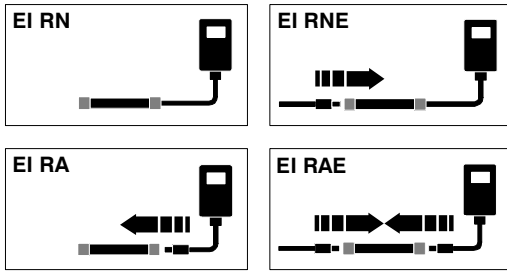

### Brackets

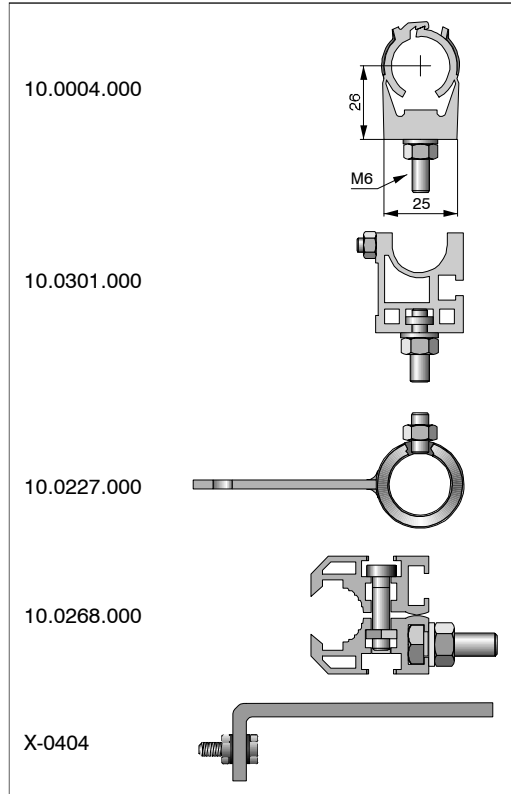

**EI RN**

### Technical data EI RN

Types: **EI RN** Order-No.: 03.8005.000  
 inseparable high-voltage cable,  
 attached permanently to bar.  
 HV-cable Order-No.: 06.0210.000

**EI RNE** Order-No.: 03.8007.000  
 detachable high-voltage cable, for  
 series connection of ionizing units.

**EI RA** Order-No.: 03.8006.000  
 for connection of a highly flexible  
 detachable HV-connection cable.

VK-Norm 21 Order-No.: 05.8517.000  
 VK-Norm 22 Order-No.: 02.8522.000  
 VK-Norm 23 Order-No.: 05.8519.000  
 VK-Norm 24 Order-No.: 05.8518.000

**EI RAE** Order-No.: 03.8008.000  
 as EI RA, for series connection of  
 ionizing units.

Diameter: 18 mm / 20 mm

Length: available from 150 to 4.500 mm  
 Other lengths on request.

Operating temperature: +5 °C to +45 °C

Storage/transport temperature: -15 °C to +60 °C

Optimum effective distance: 20 – 30 mm

Effective length: bar length - 100 mm

Smallest bending radius (cable): R 50

Subject to technical changes!

### Accessories

Bracket "Klick-Zack"	Order No.: 10.0004.000
Bracket	Order No.: 10.0301.000
Bracket	Order No.: 10.0227.000
Bracket	Order No.: 10.0268.000
Angle	Order No.: X-0404 a.o.

### Suitable power packs

Connectable lengths (ionizing unit incl. high-voltage cable):

EN SL	max. 5 m
EN SL LC	max. 10 m
EN 8 / EN 8 LC	max. 18 m
Multistat	max. 18 m
EN 70 / EN 70 LC	max. 2 x 18 m

