



# SN SERIES

Lubricated Rotary Screw Air Compressors  
Constant Speed and Variable Speed Drives

*55–75 kW • 75–100 hp*



# ABOUT SULLAIR

For more than 50 years, Sullair has been on the leading edge of compressed air solutions. We were one of the first to execute rotary screw technology in our air compressors, and our machines are famous all over the world for their legendary durability. As the industry moves forward, Sullair will always be at the forefront with quality people, innovative solutions, and air compressors that are built to last.

*Sullair was founded in Michigan City, Indiana in 1965, and has since expanded with a broad international network to serve customers in every corner of the globe. Sullair has offices in Chicago and manufacturing facilities in the United States and China — all ISO 9001 certified to ensure the highest quality standards in manufacturing. In addition, the Sullair Suzhou facility is ISO 14001 and OHSAS 18001 certified.*

***Sullair is A Hitachi Group Company***

**RELIABILITY.  
DURABILITY.  
PERFORMANCE.**

*These are the pillars that drive the quality of Sullair compressed air solutions. It's a promise we keep with every machine we make.*

## RELIABILITY

Customers who work with Sullair have found that the intangibles make all the difference — things like trust, confidence, and peace of mind. They go to work every day having full faith in their equipment, as well as the knowledge that dedicated distributors and Sullair personnel have their back every step of the way.

## DURABILITY

Bulletproof. Built to last. However you spin it, Sullair compressed air solutions are in it for the long haul, driven by the design of the legendary air end. In factories and shops all over the world, you'll find Sullair compressors that have stood the test of time, running consistently today like they did on day one.

## PERFORMANCE

You have high expectations for your operations, and we make machines that share your work ethic. Sullair compressed air solutions do what they're supposed to do, and they do it extremely well for a very long time. And working with us means not only access to clean, quality air, but also the tools you need to optimize this vital resource.



### **EFFICIENCY**

#### **HIGH-PERFORMANCE. LOW ENERGY USAGE.**

SN Series efficiency is achieved by carefully selecting high-efficiency components.

### **DURABILITY**

Sullair builds compressors to last. The keys to SN Series durability and long-lasting performance:

- Legendary Sullair Air End
- Robust 3G enclosure
- High-quality craftsmanship
- Precisely-engineered design

### **RELIABILITY**

SN Series compressors are engineered for reliable performance — helping ensure maximum uptime.

### **SERVICEABILITY**

The SN Series package is designed to make service quick and easy:

- Lift-off panels
- Oil sampling valve
- Tilt & slide oil/aftercooler
- Integrated moisture separator



# SN SERIES

*Sullair SN Series air compressors feature the robust, globally-recognized air end with a highly efficient asymmetric profile and tapered roller bearings — all backed by the Sullair comprehensive 10-year Diamond Warranty.\**

## **SN Series compressors include:**

- 3G enclosure design with lift-off panels for easy maintenance
- Improved air/oil separator design
- Oversized oil/aftercooler with higher cooling capacities (46°C/115°F)
- Efficient centrifugal fan and housing
- 7" Sullair Touch Screen Controller (STS): Provides easy access to all key compressor performance parameters
- Easy-access oil sampling valve
- Factory-filled with 10,000-hour Genuine Sullube®

## **SN Series compressors can significantly reduce operating and energy costs over the entire compressor life cycle:**

- Proven air end with the low-restriction inlet valve
- Premium efficient drive motor design
- Low-pressure-drop air/fluid separation system to help increase energy efficiency

## **Improved air filtration means:**

- Extended separator life
- Improved fluid filter life
- Less lubricant contamination

\* Maintaining the Sullair 10-Year Diamond Warranty requires using Genuine Sullair parts and Sullube, as well as the oil sampling program.

# THE SULLAIR ADVANTAGE

## STANDARD FEATURES

- Legendary air end
- Low-restriction inlet valve
- Low-carryover air/oil separator design
- High-efficiency drive and fan motor
- Integral compressor sequencing
- NEMA 4 Wye-Delta starter cabinet
- TEFC Motor
- 7" Sullair Touch Screen Controller (STS)
- Compact footprint
- Genuine Sullube® 10,000-hour, non-varnishing, biodegradable compressor fluid
- Optimalair® inlet filter designed to catch particles up to 5 times smaller compared to substitute products

## QUIET DESIGN

- Air end, motor and receiver tank mounted on rubber isolators
- Insulated intake and exhaust louvers
- Low-noise fan

## OPTIONS

- Choice of air- or water-cooled
- Cold-weather package
- Weather hood
- EES® heat recovery system
- Spiral Valve technology
- VSD starter
- Magnetic air inlet filters (standard on VSD)
- High-ambient package (55°C, 131°F)  
*Available on SN55 models only*
- PristineFG™ food grade compressor fluid
- Oil containment pan (ships loose)
- AirLinx® Remote Connectivity:
  - Provides fast and easy remote monitoring of compressor functions via any connected device



## YOUR DIAMOND DECADE STARTS TODAY

Confirming the Sullair rugged design and commitment to customer satisfaction, all new lubricated stationary air compressors (with discharge pressures up to 150 psi) include comprehensive extended warranty coverage:

### 10-year air end protection

#### 5-year coverage on:

- Main motor
- Fan motor
- Aftercooler
- Oil cooler
- Separator vessel
- Variable Speed Drive (VSD) *if equipped*

\* Maintaining the Sullair 10-Year Diamond Warranty requires using Genuine Sullair parts and Sullube, as well as the oil sampling program.



GENUINE  
**SULLUBE**  
BY SULLAIR®

**To reduce fluid disposal costs, SN Series compressors are factory-filled with biodegradable Genuine Sullube® 10,000-hour fluid.**

- Protects and cleans (no varnish)
- Controls operating temperatures
- Optimal viscosity
- Environmentally friendly
- Reduces fluid loss
- High flash point (505°F/263°C)

# SN SERIES 75–100 hp Compressors



## VARIABLE SPEED DRIVE (VSD)

- Robust, reliable and compact
- Maximum efficiency
- Operating consistency

## DRIVE COUPLING ELEMENT

- Easy-access allows change without disturbing hubs
- Designed for air end/motor protection

## AFTERCOOLER/OIL COOLER

- Oversized two-piece design helps eliminate thermal shock
- Integrated moisture separator
- Rated at 46°C/115°F



## LEGENDARY SULLAIR AIR END

- Asymmetrical rotors made in the USA
- Durable
- Proven bearing design
- Backed by 10-year Diamond Warranty\*

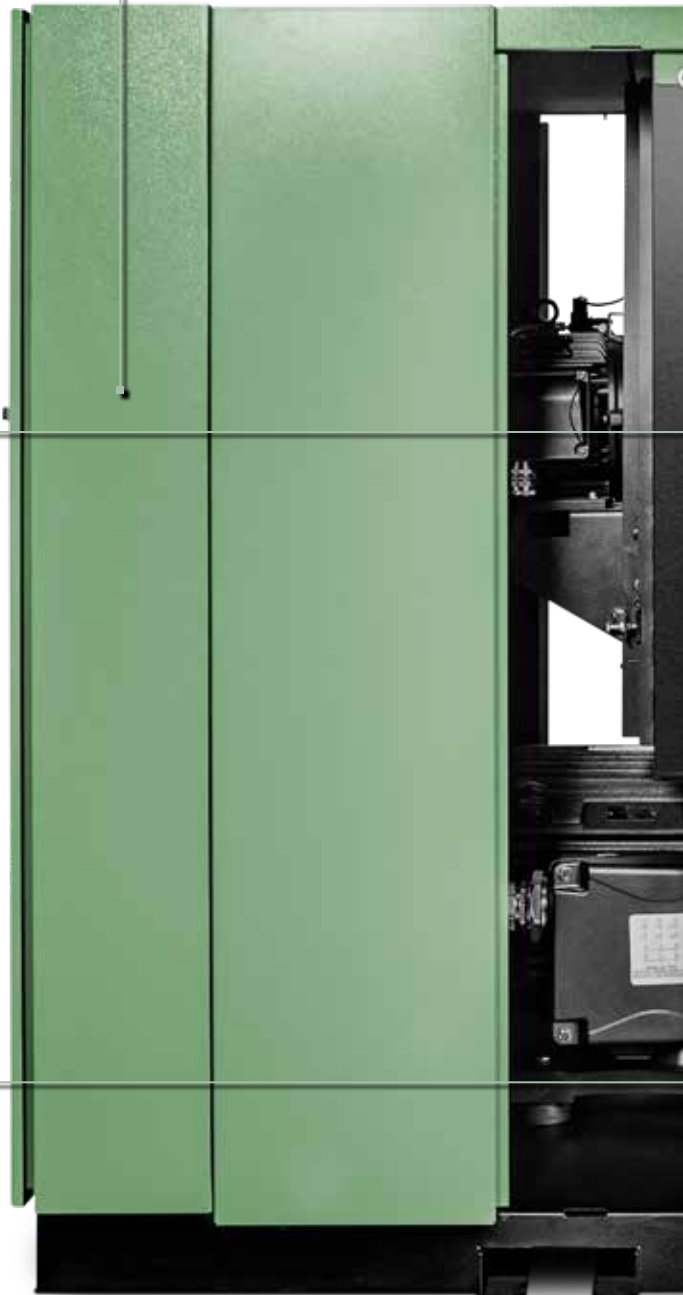

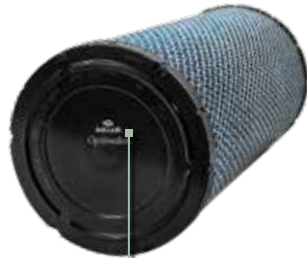

## SULLAIR OPTIMALAIR® INLET FILTER

- Provides industry's finest inlet filtration
- Keeps fluid clean and extends internal component life
- Reduced pressure drop during operating life results in energy savings
- 99.95%+ overall efficiency/0.4 micron

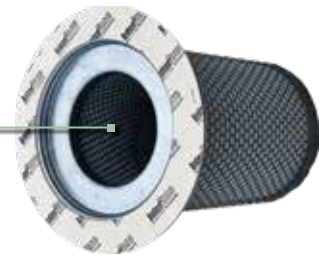
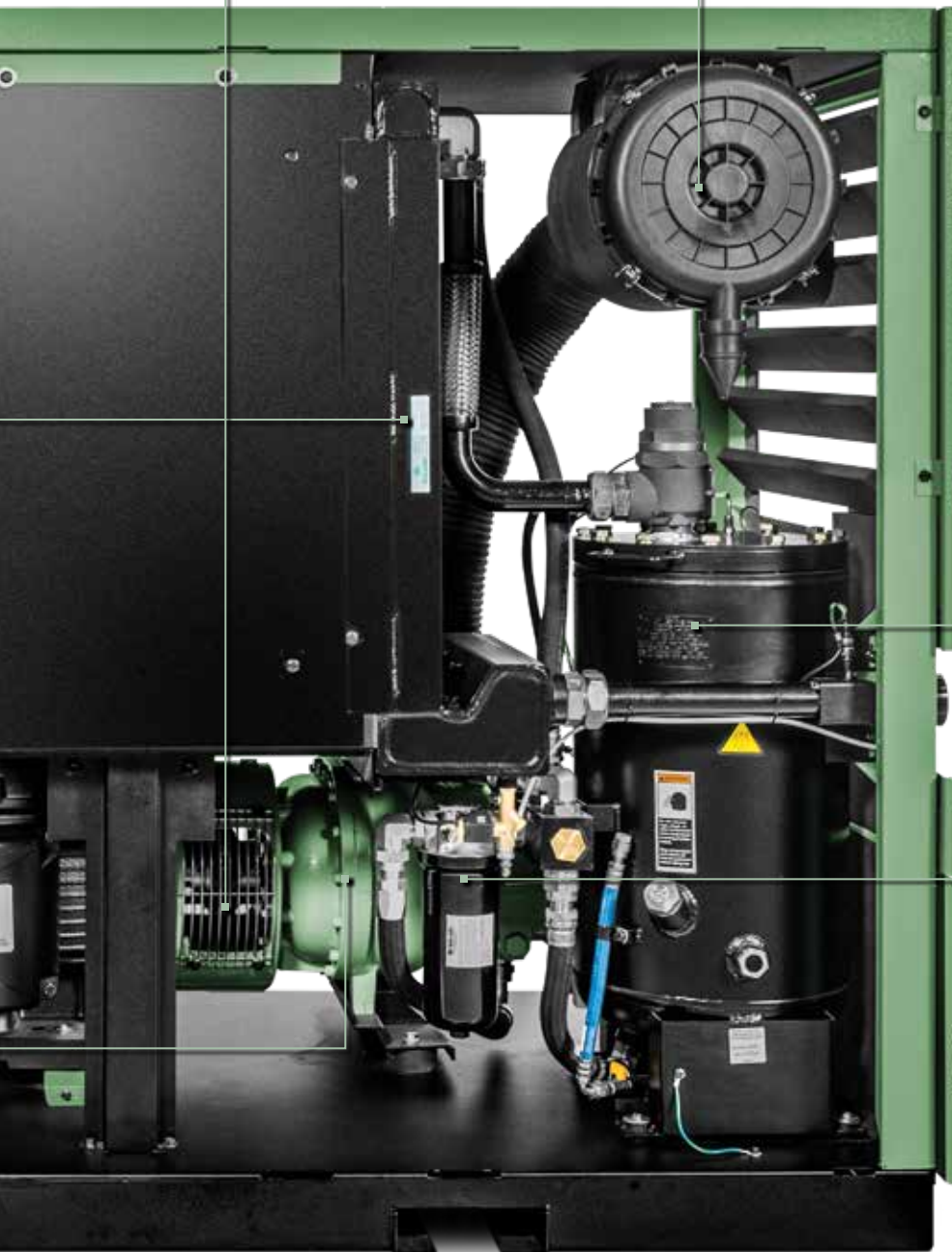

## SULLAIR OPTIMIZER™ AIR-FLUID SEPARATOR

- High-efficiency media
- Low pressure drop for reduced power consumption
- Less than 3 ppm carryover to reduce make-up fluid



## OIL SAMPLING VALVE

- Easy push button, metered valve allows for sampling while machine is in operation
- Simplifies maintaining your Diamond Warranty

# AIR COMPRESSOR CAPA

## VARIABLE SPEED DRIVE (VSD)

### PART-LOAD PERFORMANCE ASSESSMENT

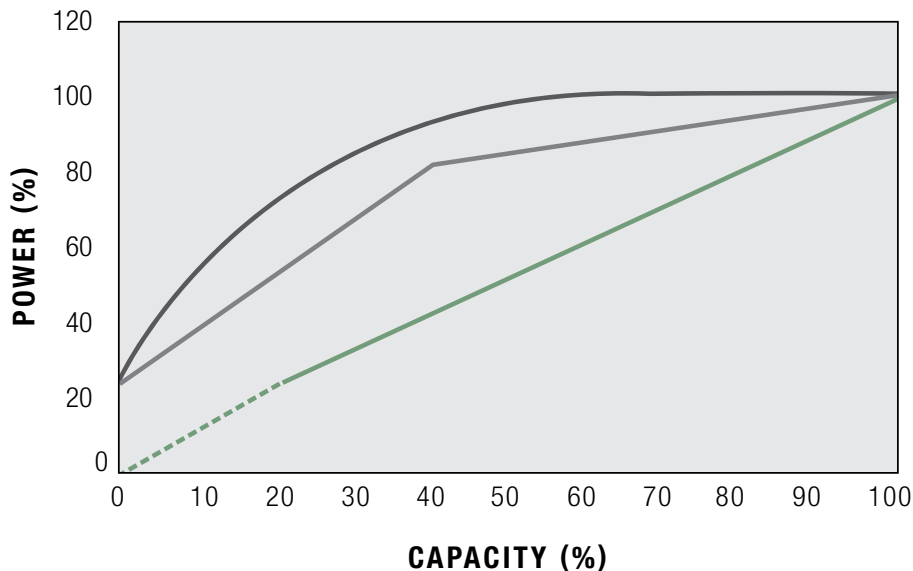

- Single-Stage Lubricated Load/Unload (based on one gallon/storage per cfm)
- Single-Stage Lubricated Inlet Modulation with Blowdown
- Single-Stage Lubricated Variable Speed



Reference: Compressed Air and Gas Handbook, 6th Edition, pages 221-223.

### FOR MAXIMUM ENERGY EFFICIENCY AND OPERATING CONSISTENCY

#### Sullair Compressors with VSD Provide:

- Excellent energy savings
- Relief from potential peak demand charges
- Possible utility company rebates
- Stable system pressure
- Consistent product quality
- Reduced system air leaks
- Reduced storage requirements
- Flexibility for future growth
- Lowest life-cycle cost
- DC link choke

*The chart above is a representation of nominal control systems for generic comparative purposes. A detailed and accurate comparison of specific compressor models is available from your authorized distributor.*

## YOUR COMPRESSED AIR SYSTEM CAN IMPROVE YOUR BOTTOM LINE:

### 35% energy savings in the first five years

In just five years, the electrical power cost to operate a standard compressor can be more than six times greater than its purchase price.

### Total compressor flexibility

Sullair VSD compressors provide flexibility to vary both capacity and pressure. This allows you to “grow” your air system without adding more compressors.

### Soft start is standard with unlimited starts and stops

- No need for Wye-Delta and other soft starters
- No need to control the number of hot or cold starts
- Unlimited starts and stops save electrical costs
- Avoids high electrical current at start-up



# CITY CONTROL OPTIONS

## SPIRAL VALVE TECHNOLOGY

### How Spiral Valve Operation Works

Compression volume varies to suit air demand by progressively opening or closing internal bypass ports on the air end.

Capacity is matched to system demand, reducing cycling time and extending component life.

Part-load capacity and efficiency can produce energy savings from 17–35%.

### Variable Displacement Air End

The Sullair Variable Displacement Air End maintains system pressure to the plant to match air demand. Since the Spiral Valve compressors use large, efficient, slow running rotors, a lower power consumption is achieved at the top end of capacity. Oil foaming does not occur, air is not wasted to atmosphere and bearings last longer.

The motor and air end run at optimum speed helping maintain optimum efficiency throughout the full variable output range.

Sullair Spiral Valve compressors react quickly to rapid changes in demand. The effective rotor length is progressively reduced as the demand is reduced which provides the most efficient part load control system to 55% output. This system is extremely simple and provides a cost effective, energy efficient control alternative.

COMPRESSOR PERFORMANCE COMPARISON

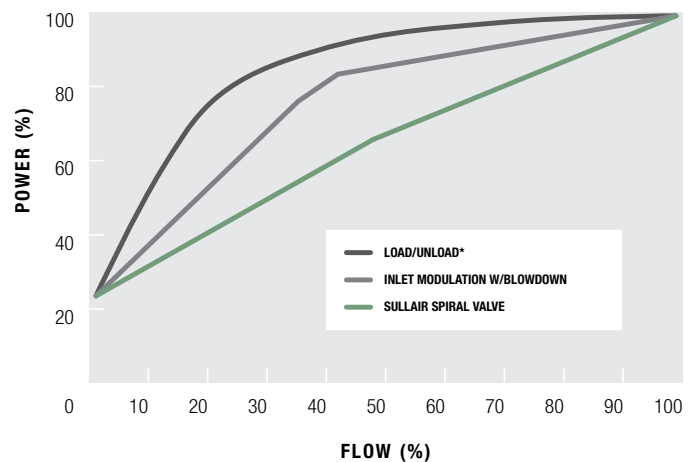

The chart above is a representation of nominal control systems for generic comparative purposes. A detailed and accurate comparison of specific compressor models is available from your authorized distributor.

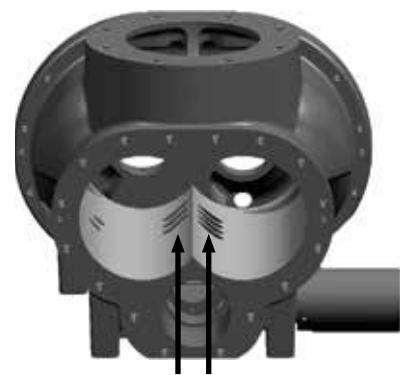

**BYPASS PORTS IN STATOR**

*Rotors removed to show Bypass Ports*

**CLOSED BYPASS PORTS**

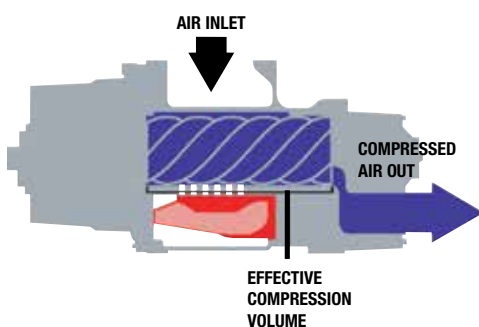

**PARTIALLY OPEN BYPASS PORTS**

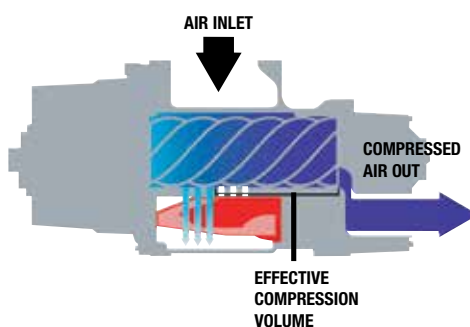

**OPEN BYPASS PORTS**

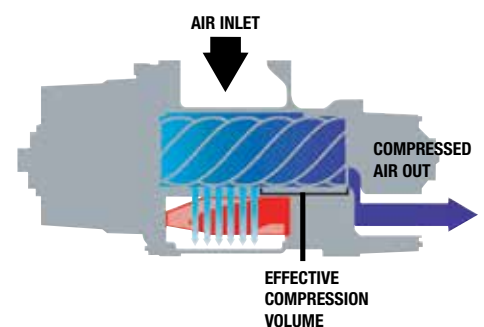

# ULTIMATE IN USER CONTROL

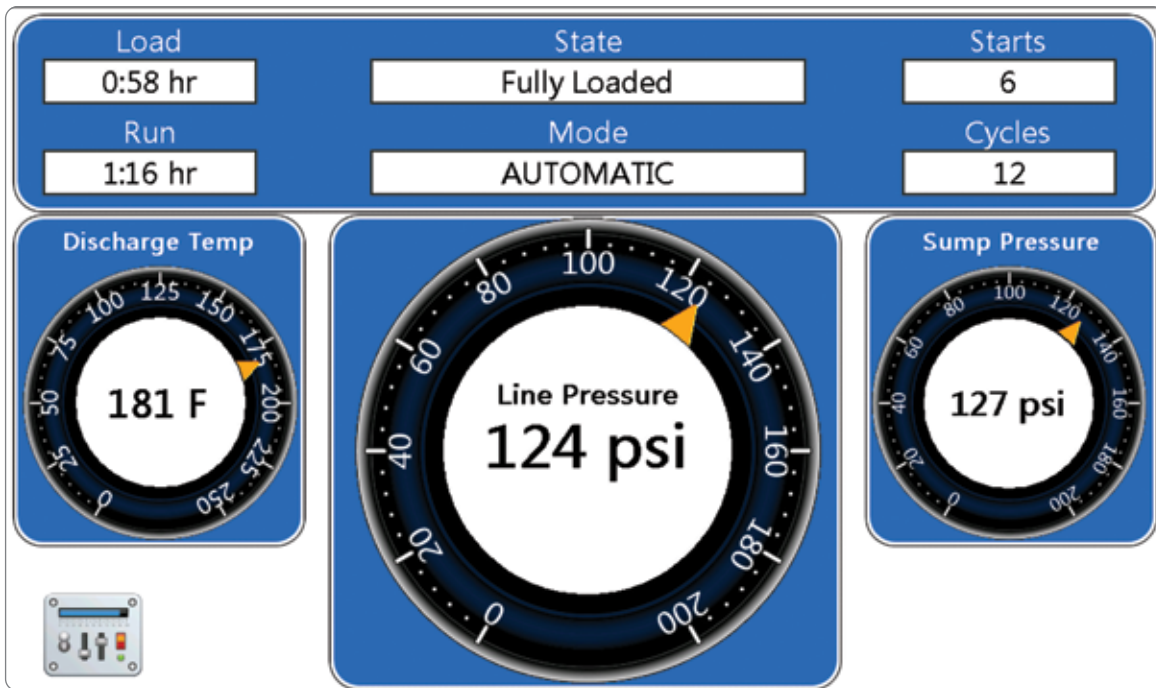

Actual Size

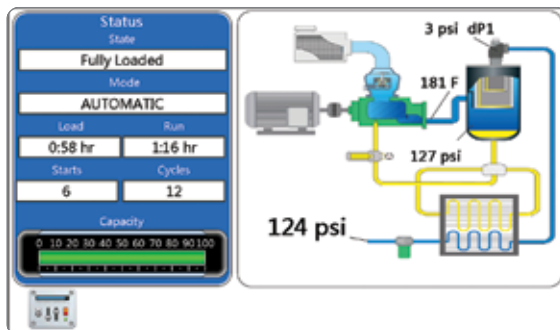

Optional Mimic Screen

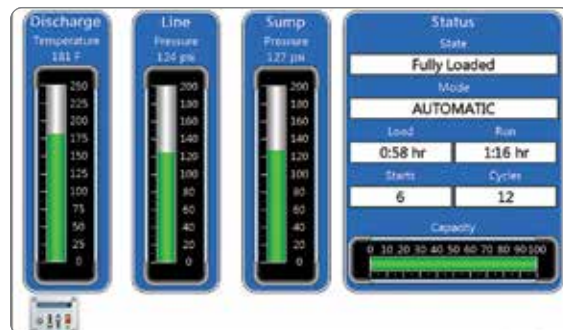

Optional Analog /Digital Screen

*The Sullair Touch Screen (STS) Controller utilizes a large 7' color screen for easy viewing in any lighting condition*

## MENU-DRIVEN SCREENS PROVIDE EASY ACCESS TO ALL COMPRESSOR CONTROLS

- Support for sequencing up to 16 compressors
- More communication capabilities: Ethernet, ModBus RTU and ModBus TCP, Cellular (AirLinX® service)
- Remote access capability via VNC (Virtual Network Computing) protocol
- Start/Stop scheduling with pressure control
- NEMA 4 environmental protection
- Discreet Start and Stop buttons
- Bright operating status LEDs even when display is dimmed
- Expandable I/O for additional sensor monitoring and output control
- Supports power monitoring
- Trend graphing of operational parameters
- Most controller functions and adjustments via protected controller submenus
- New data download capabilities

# STATIONARY AIR POWER SYSTEMS

With our expertise in analyzing, managing and controlling compressed air, Sullair offers total compressed air solutions to help you reduce energy costs and improve productivity.

- Plant air audits
- Energy efficient products
- Compressed air system controls
- Equipment to monitor and manage air systems
- Air distribution products
- After-purchase support

Plus, a full line of premium OEM parts and lubricants to help keep your compressors running optimally.

Each component of the system is carefully matched for capacity and pressure to provide maximum performance and energy efficiency.

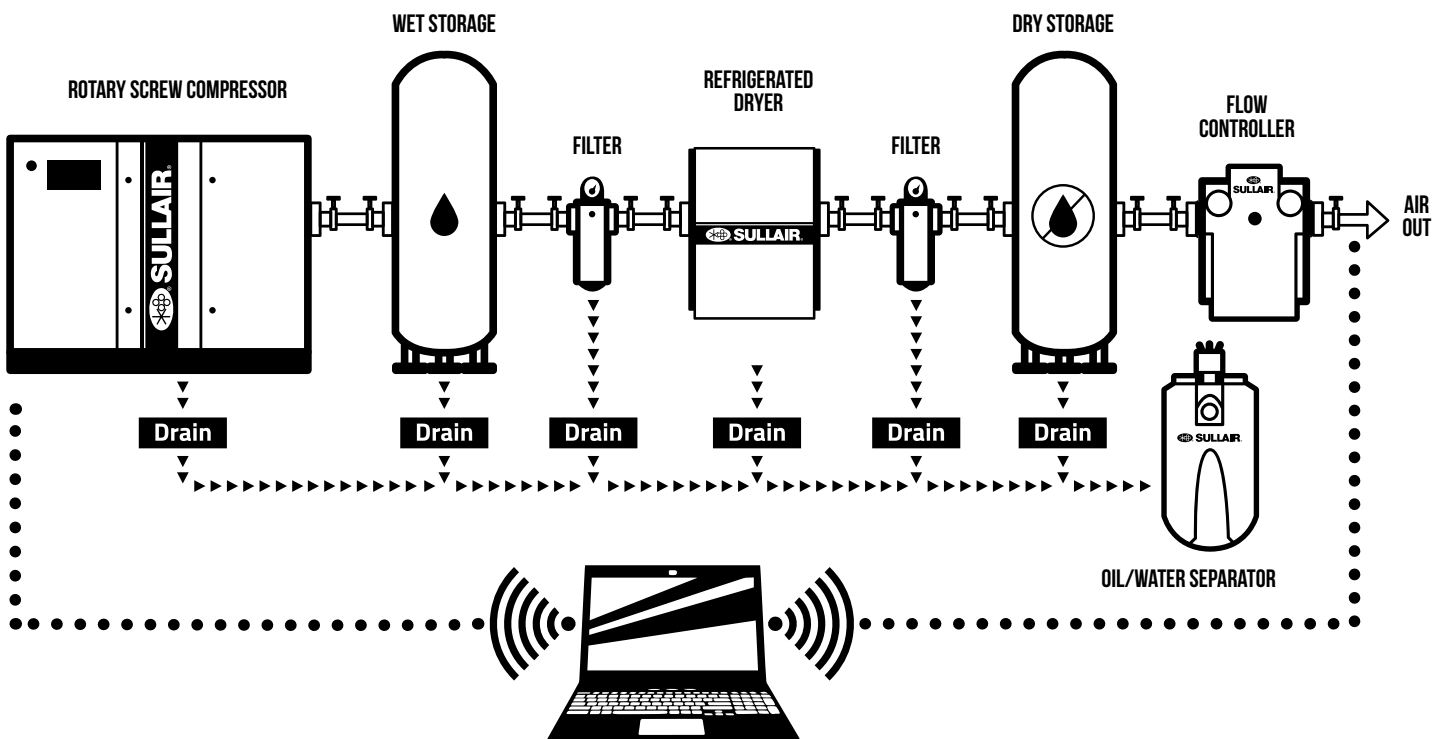

# TECHNICAL SPECIFICATIONS

FOR MORE INFORMATION, CONTACT YOUR LOCAL AUTHORIZED SULLAIR DISTRIBUTOR.

60Hz FREQUENCY			FULL LOAD CAPACITIES								WEIGHT (ODP)		DISCHARGE CONNECT	DIMENSIONS	SOUND LEVEL
MODEL #	MOTOR		100 psi acfm	7 bar m <sup>3</sup> /min	125 psi acfm	9 bar m <sup>3</sup> /min	150 psi acfm	10 bar m <sup>3</sup> /min	175 psi acfm	12 bar m <sup>3</sup> /min	lbs	kg	in	L x W x H in (mm)	dBA
	hp	kW													
SN5500	75	55	377	10.68	344	9.74	297	8.41	277	7.84	3248	1473	2" NPT	87.5 x 43.4 x 68.5 (2223 x 1103 x 1740)	70-73
SN5500V	75	55	377	10.68	341	9.66	306	8.66	278	7.87	3346	1518			
SN5500S	75	55	387	10.96	354	10.02	—	—	—	—	3390	1538			
SN7500	100	75	490	13.88	444	12.57	398	11.27	370	10.48	3476	1577			
SN7500V	100	75	500	14.16	457	12.94	420	11.89	394	11.16	3729	1691			
SN7500S	100	75	500	14.16	457	12.94	418	11.84	371	10.51	3618	1641			